



Polestar-smart

Refrigeration Dryer (50/60Hz)

IT Manuale d'uso
EN User Manual
ES Manual de uso
FR Manuel d'utilisation
DE Benutzer Handbuch
PT Manual do utilizador
SV Bruksanvisning
NL Gebruikershandleiding
PL Instrukcja obsługi
CS Návod na obsluhu
RU Руководство по эксплуата и
техническому обслуживанию
SK Návod na použitie
SU Käsikirja

PSE460
PSE520
PSE630
PSE750
PSE900
PSE1200
PSE1500
PSE1800

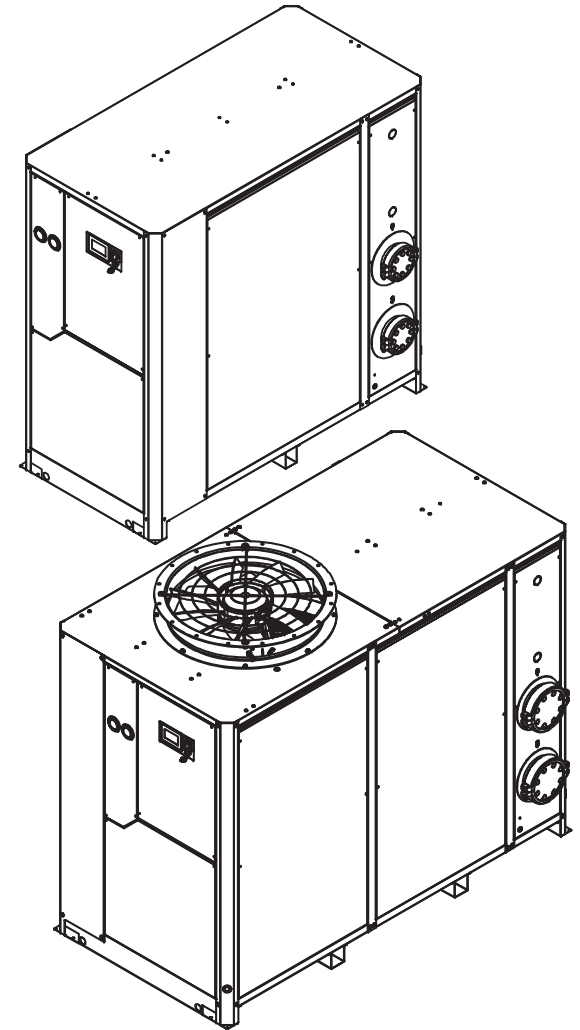
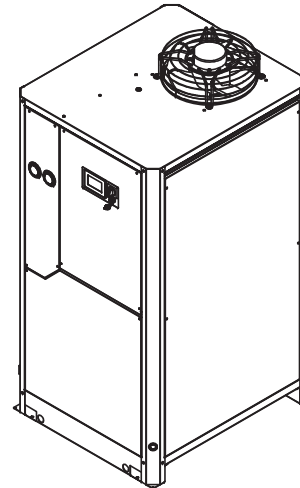

Indice

1 Sicurezza	1
1.1 Importanza del manuale.....	1
1.2 Segnali di avvertimento.....	1
1.3 Istruzioni di sicurezza.....	1
1.4 Rischi residui.....	2
2 Introduzione	2
2.1 Trasporto.....	2
2.2 Movimentazione.....	2
2.3 Ispezione.....	2
2.4 Immagazzinaggio.....	2
3 Installazione	3
3.1 Modalità.....	3
3.2 Spazio operativo.....	3
3.3 Versione condensatore.....	3
3.4 Suggerimenti.....	3
3.5 Collegamento elettrico.....	3
3.6 Collegamento scarico condensa.....	3
4 Messa in servizio	4
4.1 Controlli preliminari.....	4
4.2 Avviamento.....	4
4.3 Funzionamento.....	4
4.4 Fermata.....	4
5 Controllo	5
5.1 Pannello di controllo.....	5
5.2 Menu principale.....	5
5.2.1 Stato Macchina (I/O).....	5
5.2.2 Pressione.....	6
5.2.3 Temperature.....	6
5.2.4 Scarico Dati.....	7
5.2.5 Numero di serie.....	7
5.2.6 Impostazione generale.....	7
5.2.6.1 Lingua.....	7
5.2.6.2 Data/tempo.....	7
5.2.6.3 Menu user.....	8
5.2.6.4 Parametri.....	8
5.3 Allarmi/avvisi.....	10
5.3.1 Lista allarmi/avvisi.....	10
5.4 Menu rapido.....	11
6 Manutenzione	12
6.1 Avvertenze generali.....	12
6.2 Refrigerante.....	12
6.3 Programma di manutenzione.....	12
6.4 Smantellamento.....	13
7 Ricerca guasti	14
8 Appendice	

1 Sicurezza

1.1 Importanza del manuale

- Conservarlo per tutta la vita della macchina.
- Leggerlo prima di qualsiasi operazione.
- E' suscettibile di modifiche: per una informazione aggiornata consultare la versione a bordo macchina.

1.2 Segnali di avvertimento



Istruzione per evitare pericoli a persone.



Istruzione da eseguire per evitare danni all'apparecchio.





E' richiesta la presenza di tecnico esperto e autorizzato.





Sono presenti simboli il cui significato è nel paragrafo 8.1

1.3 Istruzioni di sicurezza

 Ogni unità è munita di sezionatore elettrico per intervenire in condizioni di sicurezza. Usare sempre tale dispositivo per eliminare i pericoli durante la manutenzione.

 Il manuale è rivolto all'utente finale solo per operazioni eseguibili a pannelli chiusi: operazioni che ne richiedono l'apertura con attrezzi devono essere eseguite da personale esperto e qualificato.

 Non superare i limiti di progetto riportati nella targa dati.

  È compito dell'utilizzatore evitare carichi diversi dalla pressione statica interna. Qualora sussista il rischio di azioni sismiche l'unità va adeguatamente protetta.

 I dispositivi di sicurezza sul circuito d'aria compressa sono a carico dell'utilizzatore.

 Il dimensionamento dei dispositivi di sicurezza del circuito dell'aria compressa si esegue tenendo conto delle caratteristiche tecniche dell'impianto e della legislazione localmente in vigore.

Impiegare l'unità esclusivamente per uso professionale e per lo scopo per cui è stata progettata. E' compito dell'utilizzatore analizzare tutti gli aspetti dell'applicazione in cui il prodotto è installato, seguire tutti gli standards industriali di sicurezza applicabili e tutte le prescrizioni inerenti il prodotto contenute nel manuale d'uso ed in qualsiasi documentazione prodotta e fornita con l'unità.

La manomissione o sostituzione di qualsiasi componente da parte di personale non autorizzato e/o l'uso improprio dell'unità esonerano il costruttore da qualsiasi responsabilità e provocano l'invalidità della garanzia.

Si declina ogni responsabilità presente e futura per danni a persone, cose e alla stessa unità, derivanti da negligenza degli operatori, dal mancato rispetto di tutte le istruzioni riportate nel presente manuale, dalla mancata applicazione delle normative vigenti relative alla sicurezza dell'impianto.

Il costruttore non si assume la responsabilità per eventuali danni dovuti ad alterazioni e/o modifiche dell'imballo.

E' responsabilità dell'utilizzatore assicurarsi che le specifiche fornite per la selezione dell'unità o di suoi componenti e/o opzioni siano esaustive ai fini di un uso corretto o ragionevolmente prevedibile dell'unità stessa o dei componenti.

 **ATTENZIONE: Il costruttore si riserva il diritto di modificare le informazioni contenute nel presente manuale senza alcun preavviso. Ai fini di una completa ed aggiornata informazione si raccomanda all'utente di consultare il costruttore.**

1.4 Rischi residui

L'installazione, l'avviamento, lo spegnimento, la manutenzione della macchina devono essere tassativamente eseguiti in accordo con quanto riportato nella documentazione tecnica del prodotto e comunque in modo che non venga generata alcuna situazione di rischio. I rischi che non è stato possibile eliminare in fase di progettazione sono riportati nella tabella seguente.

parte considerata	rischio residuo	modalità	precauzioni
batteria di scambio termico	piccole ferite da taglio	contatto	evitare il contatto, usare guanti protettivi
griglia ventilatore e ventilatore	lesioni	inserimento di oggetti appuntiti attraverso la griglia mentre il ventilatore sta funzionando	non infilare oggetti di alcun tipo dentro la griglia dei ventilatori e non appoggiare oggetti sopra le griglie
interno unità: compressore e tubo di mandata	ustioni	contatto	evitare il contatto, usare guanti protettivi
interno unità: parti metalliche e cavi elettrici	intossicazioni, folgorazione, ustioni gravi	difetto di isolamento cavi alimentazione a monte del quadro elettrico dell'unità. Parti metalliche in tensione	protezione elettrica adeguata della linea alimentazione. Massima cura nel fare il collegamento a terra delle parti metalliche
esterno unità: zona circostante unità	intossicazioni, ustioni gravi	incendio a causa corto circuito o surriscaldamento della linea alimentazione a monte del quadro elettrico dell'unità	sezione dei cavi e sistema di protezione della linea alimentazione elettrica conformi alle norme vigenti

2 Introduzione

Questo manuale fa riferimento agli essiccatori frigoriferi progettati per rimuovere il vapore acqueo dall'aria compressa.

2.1 Trasporto

L'unità imballata deve rimanere:

- in posizione verticale;
- protetta da agenti atmosferici;
- protetta da urti.

2.2 Movimentazione

Usare carrello elevatore a forca adeguato al peso da sollevare, evitando urti di qualsiasi tipo.

2.3 Ispezione

- In fabbrica tutte le unità sono assemblate, cablate, caricate con refrigerante ed olio, collaudate alle condizioni di lavoro standard;
- Ricevuta la macchina controllarne lo stato: contestare subito alla compagnia di trasporto eventuali danni;
- Disimballare l'unità il più vicino possibile al luogo dell'installazione.

2.4 Immagazzinaggio

Se è necessario sovrapporre più unità, seguire le note riportate sull'imballo. Mantenere l'unità imballata in luogo pulito e protetto da umidità e intemperie.

3 Installazione

☞ Installare all'interno in un'area pulita, asciutta e protetta dagli elementi, dalla luce solare diretta e / o da altre condizioni difficili.

⚠ La macchina deve essere installata in ambienti adeguatamente protetti contro rischi di incendio (riferimento norma EN378-3).

3.1 Modalità

⚠ Assicurarsi di avvitare i prigionieri nelle flange fino a fine corsa prima di collegare le contronflange (vedere paragrafo 8.6).

☞ Rispettare le indicazioni riportate nei paragrafi 8.2 e 8.3.

Tutti gli essiccatori devono essere forniti di adeguato pre-filtro installato vicino all'ingresso aria dell'essiccatore. La ditta fornitrice esclude ogni obbligo di indennizzo o risarcimento per eventuali danni diretti o indiretti derivanti dalla mancata installazione del pre-filtro

☞ L'elemento pre-filtrante (per filtrazione fino a 3 micron o inferiore) deve essere sostituito almeno una volta l'anno o nell'intervallo indicato dal produttore.

☞ Collegare correttamente l'essiccatore su attacchi ingresso/uscita aria compressa.

3.2 Spazio operativo

☞ Lasciare uno spazio di 1.5 metri attorno all'unità.

Lasciare 2 metri di spazio sopra l'essiccatore nei modelli ad espulsione verticale dell'aria di condensazione.

3.3 Versione condensatore

Versione ad aria (Ac)

Non creare situazioni di ricircolo dell'aria di raffreddamento.

Non ostruire le griglie di ventilazione.

Versione ad acqua (Wc)

Se non previsto in fornitura, installare filtro a rete su ingresso acqua di condensazione.



Caratteristiche acqua di condensazione in ingresso:

Temperatura	≥50°F (10°C)	CL ⁻	<50 ppm
ΔT IN/OUT	5-15°C	CaCO ₃	70-150 ppm
Max % glicole	50	O ₂	<0.1 ppm
Pressione	43.5-145 PSIG (3-10 barg)	Fe	<0.2 ppm
PH	7.5-9	NO ₃	<2 ppm
Conduttività elettrica	10-500 μS/cm	HCO ₃ ⁻	70-300 ppm
Indice di saturazione di Langelier	0-1	H ₂ S	<0.05 ppm
SO ₄ ²⁻	<50 ppm	CO ₂	<5 ppm
NH ₃	<1 ppm	Al	<0.2 ppm

Per particolari acque di raffreddamento (deionizzata, demineralizzata, distillata) i materiali standard previsti per il condensatore potrebbero non essere adatti. In questi casi si prega di contattare il costruttore.

3.4 Suggerimenti

Per non danneggiare i componenti interni di essiccatore e compressore d'aria, evitare installazioni in cui l'aria dell'ambiente circostante contenga contaminanti solidi e/o gassosi: attenzione quindi a zolfo, ammoniaca, cloro e ad installazioni in ambiente marino.

La canalizzazione dell'aria è da evitare per le versioni con ventilatori assiali.

3.5 Collegamento elettrico

Usare cavo omologato ai sensi di leggi e normative locali (per sezione minima cavo vedere paragrafo 8.3). Installare interruttore magnetotermico differenziale a monte dell'impianto (RCCB - IDn = 0.3A) con distanza tra i contatti in condizione di apertura 3 mm (vedere normative locali vigenti in materia).

La corrente nominale "In" di tale magnetotermico deve essere uguale a FLA e la curva di intervento di tipo D.

Seleziona l'alimentazione inserendo il ponte come descritto:

S7-S6 per 400/3/50

S8-S6 per 460/3/60

All'interno del quadro si trova una tabella con le istruzioni.

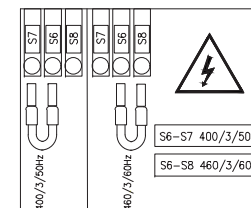

3.6 Collegamento scarico condensa

☞ Eseguire la connessione al sistema di scarico evitando il collegamento in circuito chiuso in comune con altre linee di scarico pressurizzate. Controllare il corretto deflusso degli scarichi condensa. Smaltire tutta la condensa in conformità alle locali normative ambientali vigenti.

4 Messa in servizio

4.1 Controlli preliminari

Prima di avviare l'essiccatore verificare che:

- l'installazione sia stata eseguita secondo quanto prescritto al capitolo 3;
- le valvole ingresso aria siano chiuse e che non ci sia flusso d'aria attraverso l'essiccatore;
- l'alimentazione fornita sia corretta.
- in versione Wc aprire il circuito dell'acqua di raffreddamento solo pochi minuti prima dell'avvio essiccatore.

4.2 Avviamento

1. Dare tensione ruotando l'INTERRUTTORE GENERALE



" su "I ON": appare questa informazione:

 **LA RESISTENZA CARTER DEVE ESSERE INSERITA 12 ORE PRIMA DI AVVIARE L'ESSICCATORE.**

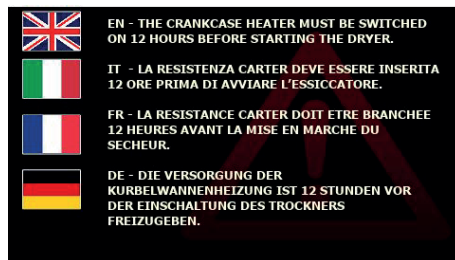

Tocca per vedere il pannello di controllo.

2. Toccare  per accendere, il pulsante cambia di colore da grigio a verde, a segnalare che il dryer

è ora in funzione .

3. Avviare l'essiccatore prima del compressore d'aria;
Un'incorretta operazione può danneggiare seriamente il compressore frigorifero.

 Ventilatori (Versione Ac): se alimentati con errata sequenza di fase ruotano in direzione opposta rischiando di danneggiarsi (in questo caso il flusso dell'aria del cabinet dell'essiccatore non esce dalla griglia del ventilatore bensì dalle griglie dei condensatori - vedere i paragrafi 8.6 e 8.7 per il corretto flusso dell'aria); invertire subito due fasi.

4. Aspettare 5 minuti, quindi aprire lentamente la valvola ingresso aria;
5. Aprire lentamente la valvola uscita aria: l'essiccatore sta ora essiccando.

Monitore di fase

Se al l' avviamento del dryer compare a display l'allarme "monitore di fase", l'utente deve verificare di avere eseguito correttamente il cablaggio dei morsetti di ingresso all'interruttore sezionatore del dryer.

4.3 Funzionamento

- Lasciare in marcia l'essiccatore durante tutto il periodo di funzionamento del compressore d'aria;
- L'essiccatore funziona in modo automatico, non sono quindi richieste tarature sul campo;
- Se si verificano flussi d'aria eccessivi ed inaspettati, by-passare per evitare di sovraccaricare l'essiccatore;
- Evitare fluttuazioni della temperatura di ingresso dell'aria.

4.4 Fermata

1. Fermare l'essiccatore 2 minuti dopo l'arresto del compressore d'aria o comunque dopo l'interruzione del flusso d'aria;
2. Evitare che aria compressa fluisca nell'essiccatore quando questo è disinserito o in presenza di un allarme.



3. Toccare  per spegnere il dryer. Il pulsante cambia di colore cambiando in grigio 



4. Ruotare l'INTERRUTTORE GENERALE "  " su "O OFF" per togliere tensione.

 Versione **Wc** chiudere circuito acqua con essiccatore fermo.

5 Controllo

5.1 Pannello di controllo

25/giu/2021 - 11:04:39

LOCAL [Power Off] [Info] [Warning]

FS 0% HGBV 0% ECO 0%

°C 0.0 PDP

MANUAL DRAIN

Tasti Touch	Funzione
[Power Off]	Essiccatore OFF (Nero)
[Power On]	Essiccatore ON (Verde)

LOCAL = Configurazione Locale
REMOTE = Configurazione Remote

Funzione	Tasti Touch	Funzione
<p>FS 48 %</p> <p>Percentuale di lavoro del ventilatore. (solo per versione condensatore ad aria)</p>	[Info]	Si accede al menu informazioni: stato macchina, pressioni, temperature, impostazioni generali, consumi, password utente
<p>HGBV 14 %</p> <p>Percentuale di lavoro della valvola gas caldo</p>	[Warning]	Grigio = nessun allarme Rosso = avviso Rosso lampeggiante = reset allarme
<p>ECO 0%</p> <p>Energy saving %(cycling)</p>	[Snowflake]	Dryer OFF = luce grigia Cycling attivo = luce verde lampeggiante Compressore attivo = luce blue
	[Water Drop]	Grigio = scaricatore condensa OFF Verde = scaricatore condensa ON

Funzione	Tasti Touch	Funzione
<p>°C 8.0 PDP</p> <p>Andamento del dew point</p>	MANUAL DRAIN	Toccare: per uno scarico manuale.

Funzione
<p>Strep led: blu = Compressore attivo verde = energy saving rosso = allarme</p>

5.2 Menu principale

Toccare per accedere al menu "informazioni":

Quando si tocca uno dei "pulsanti touch", per qualche secondo il contorno si illumina a conferma che la selezione è stata effettuata.

Questo per ogni "pulsante touch" presente nel pannello di controllo.

Toccare per tornare al pannello di controllo.

OFF

Temperatures Pressures

Status of I/O Serial Number

USB Save data

General setting

5.2.1 Stato Macchina (I/O)

Toccare per entrare nel menu "stato macchina".

Questa la lista degli ingressi: Un led vicino alla descrizione indica se la protezione/funzione/configurazione è: attivo= verde non attivo= grigio

Toccare per entrare nella pagina successiva.

Questa la lista delle uscite:

Toccare per tornare al menu precedente.

OFF

Status of Input

- High pressure switch
- Low pressure switch
- Thermal protection compressor
- Thermal protection fan
- Phases sequence control
- Dryer remote control
- Condensate level 1
- Condensate level 2
- Condensate level 3

OFF

Status of Output

- Plant status ON
- General Alarm
- Compressor ON
- Fan ON
- Liquid solenoid valve
- Condensate drain 1
- Condensate drain 2
- Condensate drain 3

5.2.2 Pressione

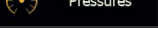
Toccare  per entrare nel menu "pressioni" per visualizzare: la pressione di condensazione, la percentuale di lavoro del ventilatore, la pressione di evaporazione e la percentuale di apertura della valvola gas caldo.

Toccare un parametro specifico per visualizzarne l'andamento dei dati nel tempo

"Pressioni di condensazione ed evaporazione"

usare  e  per scorrere sul grafico.

"Percentuali lavoro ventilatore e percentuale aperture valvola gas caldo"

usare  e  per scorrere sul grafico.

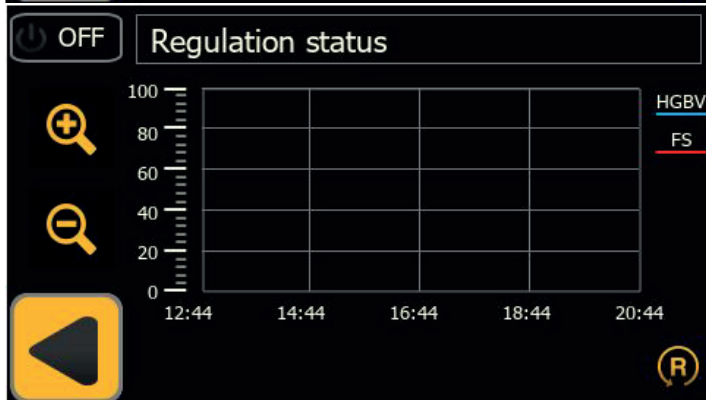
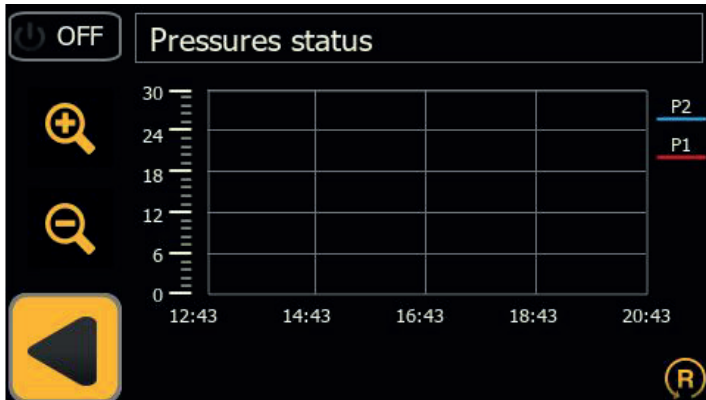
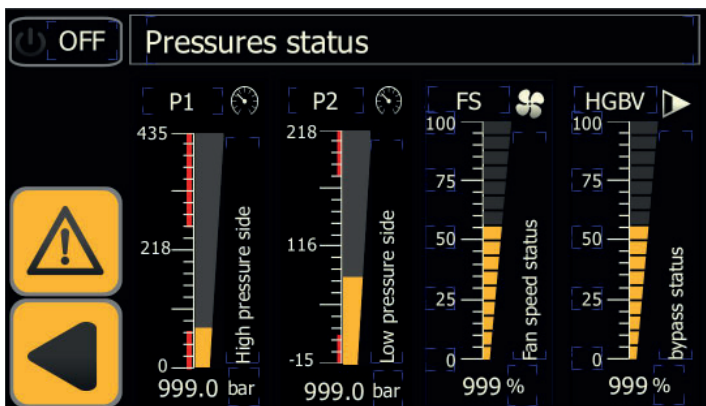

5.2.3 Temperature

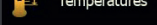
Toccare  per visualizzare le temperature lette dai sensori presenti nel circuito frigo.

Toccare  per entrare nella pagina successiva.

B4 = attiva solo per versioni multicooler.

Toccare uno dei valori delle temperature di bassa pressione per visualizzare l'andamento dei dati di tutte le sonde del circuito di bassa pressione.

Toccare uno dei valori di temperatura di alta pressione per visualizzare l'andamento dei dati di tutte le sonde nel circuito di alta pressione

Andamento bassa pressione

usare  e  per scorrere sul grafico.

Andamento alta pressione

usare  e  per scorrere sul grafico.

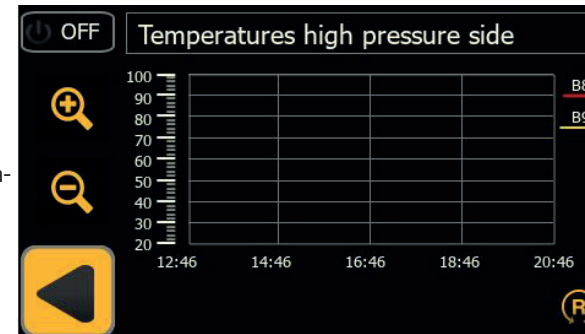
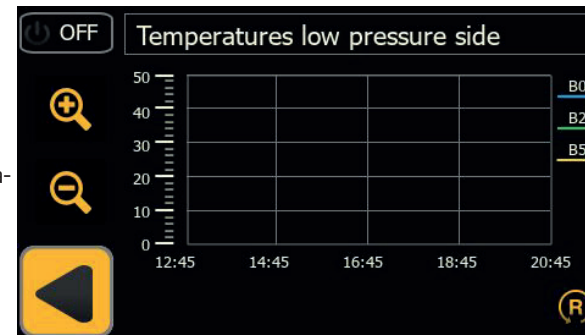
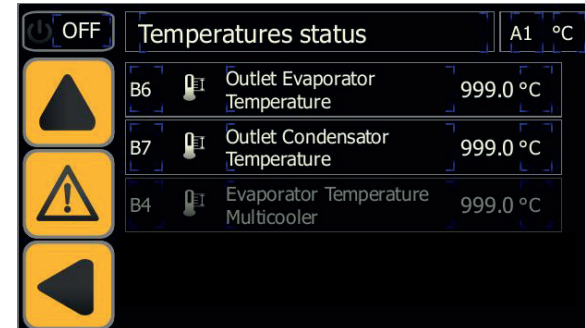
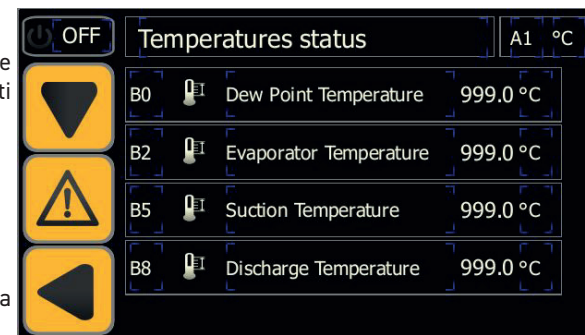

5.2.4 Scarico Dati

Utilizza una USB con led , che mostra la fase di downloading.(8gB formattata come FAT32) inserire nel pannello frontale.

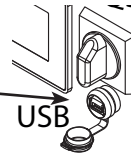

Toccare  per iniziare lo scarico dei dati.

Il tempo di scarico dati dipende dalla quantità dei dati memorizzati.

5.2.5 Numero di serie

Toccare  per entrare nella finestra "serial number".

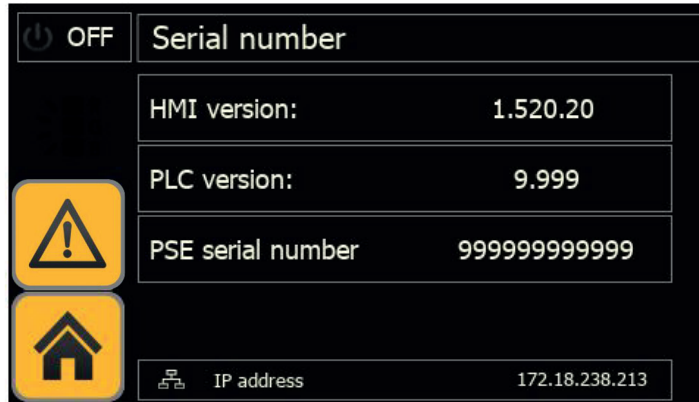

Toccare  per tornare al pannello principale.

5.2.6 Impostazione generale

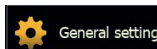
Toccare  per entrare nel menu "generale" con le seguenti sezioni: lingua; data/ora; parametri ; manutenzione; funzionamento ciclico o continuo.

toccare qualsiasi menu per visualizzare / regolare.

Toccare  per tornare al pannello principale.

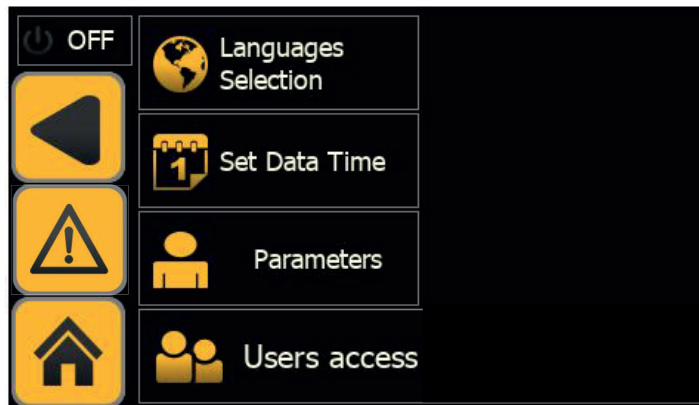

5.2.6.1 Lingua

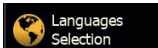
Toccare  per entrare nel menu "lingue". Toccare la lingua desiderata. Automaticamente si torna al menu principale con la lingua scelta.

Toccare  per tornare al menu precedente.

Toccare la lingua desiderata. Automaticamente si torna al menu principale con la lingua scelta.

Toccare  per tornare al menu precedente.



5.2.6.2 Data/tempo

Toccare  per entrare nel menu "data/tempo".

Toccare Data/Tempo per procedere alla modifica.

Premere



per 2 secondi per confermare.

Toccare  per tornare al menu precedente.

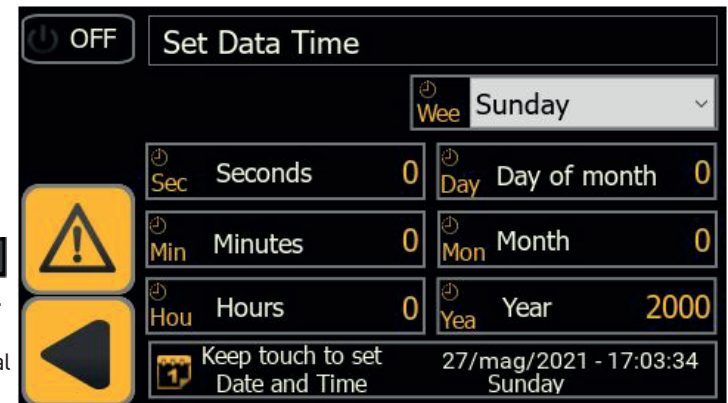

5.2.6.3 Menu user

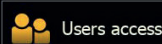
Toccare  Users access per entrare nel "User" menu. Questo menu è riservato a tecnici service Parker.

User name:

Password:

Show password

5.2.6.4 Parametri

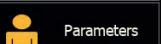
Toccare  Parameters per entrare nel menu "parametri" con le seguenti sezioni: sonde, scaricatore, configurazione, manutenzione, cicli.

Toccare uno dei "pulsanti touch" per entrare nel menu.

Toccare  per tornare al menu precedente.

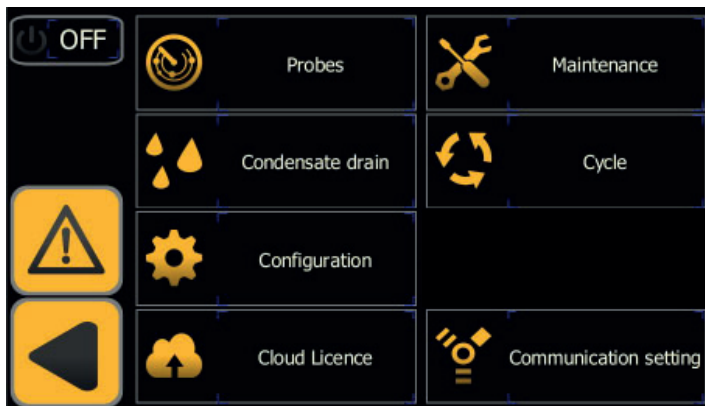

Sonde

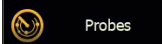
Toccare  Probes per impostare i parametri avvisi e ritardi o valore minimo e massimo di dew point.

Toccare  per tornare al menu precedente.

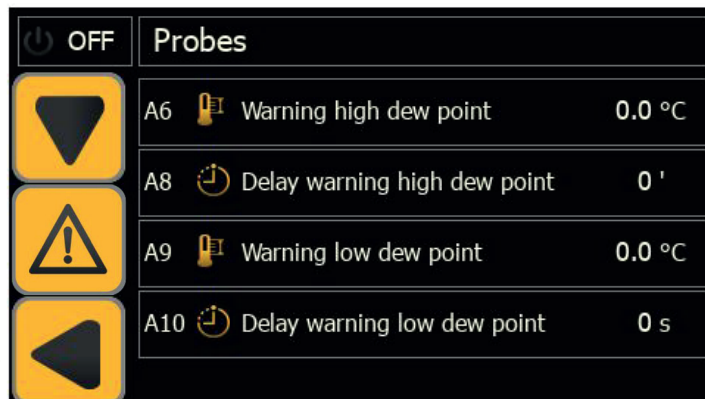

Scaricatore di condensa

Toccare  Condensate drain per entrare nella menu "scaricatore di condensa" per impostare:
1. Scaricatore temporizzato (scegliendo i tempi di chiusura ed apertura);
2. Scaricatore capacitivo;
3. Scaricatore continuo (esterno).

Toccare  per tornare al menu precedente.

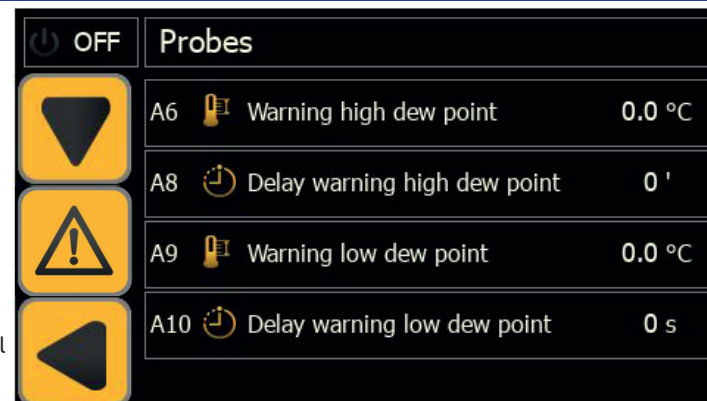

Configurazione

Toccare  Configuration per entrare nel menu "configurazione" con le seguenti sezioni:

1. Scelta del grado di temperatura °C/°F;
2. Abilitazione del controllo remoto;
3. Abilitazione dei soli allarmi o allarmi/avvisi;
4. Reset delle impostazioni con i parametri di default.

usare il pulsante touch a fianco della descrizione per effettuare la scelta.

 Per gestire la modalità **SPEGNIMENTO REMOTO** rimuovere il ponte tra i morsetti: 87-92 e collegare l'interruttore di marcia/arresto remoto (a cura del cliente).

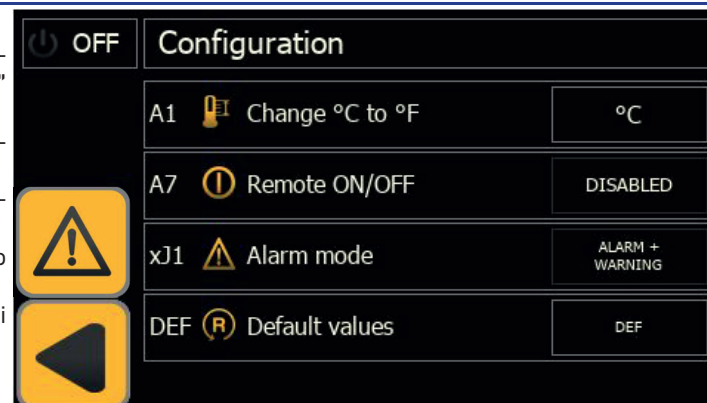

Manutenzione

Toccare  per poter visualizzare le ore di lavoro del compressore e del dryer.

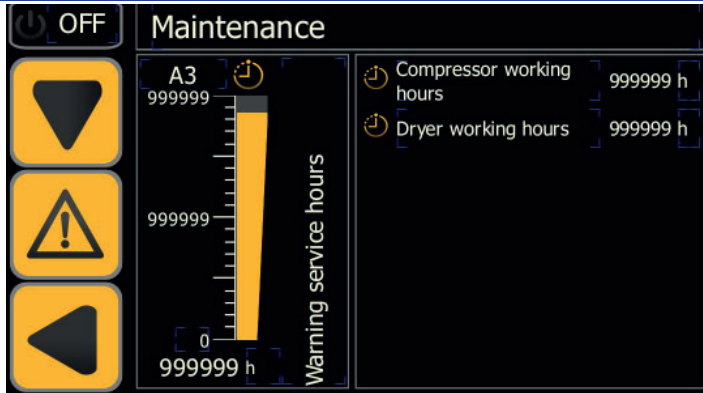

The screenshot shows the 'Maintenance' screen with a power button labeled 'OFF'. On the left, there are three navigation buttons: a downward arrow, a warning triangle, and a leftward arrow. The main area features a vertical bar graph labeled 'Warming service hours' with a scale from 0 to 999999 h. To the right, there are two rows of data: 'Compressor working hours' and 'Dryer working hours', both showing '999999 h'.

Toccare  per tornare al menu precedente.

Funzionamento

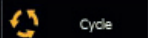
Toccare  per scegliere la modalità di funzionamento : continuo; ciclico (energy saving).

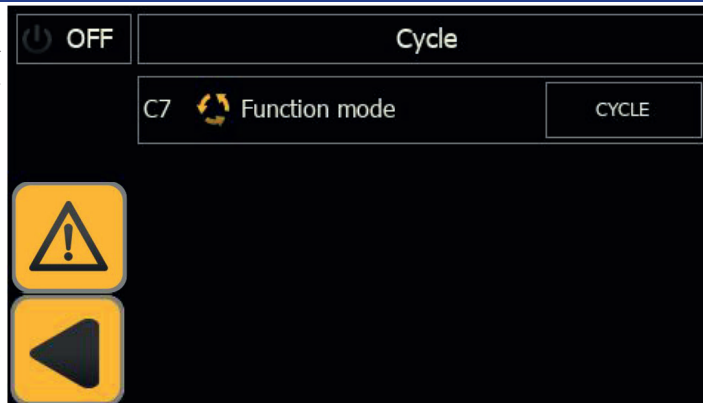

The screenshot shows the 'Cycle' screen with a power button labeled 'OFF'. On the left, there are two navigation buttons: a warning triangle and a leftward arrow. The main area displays 'C7 Function mode' and a 'CYCLE' button.

Toccare il parametro per effettuare la regolazione.

Toccare  per tornare al menu precedente.

Modbus

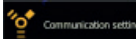
Toccare  per impostare i parametri Modbus MODBUS RTU (RS485)

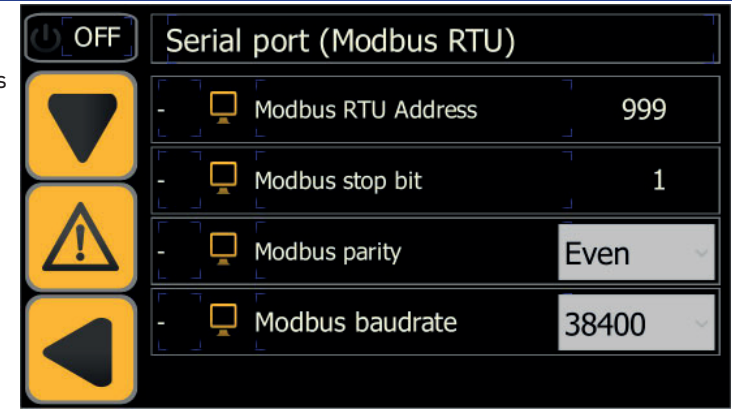

The screenshot shows the 'Serial port (Modbus RTU)' screen with a power button labeled 'OFF'. On the left, there are three navigation buttons: a downward arrow, a warning triangle, and a leftward arrow. The main area contains four rows of settings: 'Modbus RTU Address' (999), 'Modbus stop bit' (1), 'Modbus parity' (Even), and 'Modbus baudrate' (38400).

Toccare  per entrare nella pagina successiva.

MODBUS TCP/IP

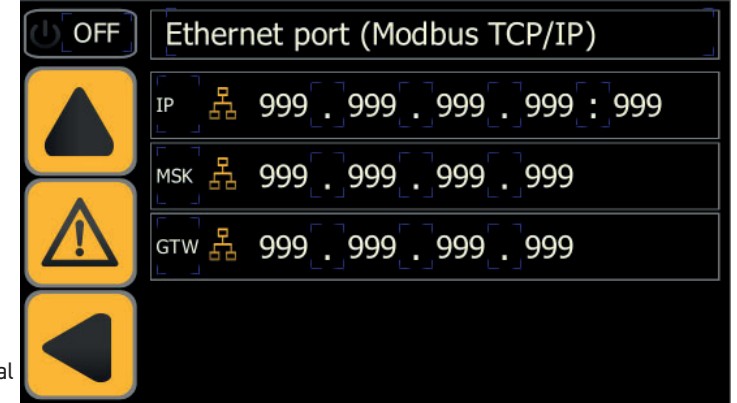

The screenshot shows the 'Ethernet port (Modbus TCP/IP)' screen with a power button labeled 'OFF'. On the left, there are three navigation buttons: a warning triangle, a warning triangle, and a leftward arrow. The main area contains three rows of settings: 'IP' (999 . 999 . 999 . 999 : 999), 'MSK' (999 . 999 . 999 . 999), and 'GTW' (999 . 999 . 999 . 999).

Toccare  per tornare al menu precedente.

Spegnere e riaccendere l'essiccatore per confermare la configurazione.

Cloud

Toccare  per vedere la "password" per il cloud.

questa opzione non è ancora disponibile.

Toccare  per tornare al menu precedente.



The screenshot shows the 'Cloud Licence' screen with a power button labeled 'OFF'. On the left, there are two navigation buttons: a warning triangle and a leftward arrow. The main area displays a password field with a cloud icon and the value '99999'.

5.3 Allarmi/avvisi

Scegliere in "configuration"se vedere allarmi o allarmi/avvisi

Toccare  per entrare nel menu "allarmi /avvisi":

Toccare "duration" per cambiare il tempo di ricerca.

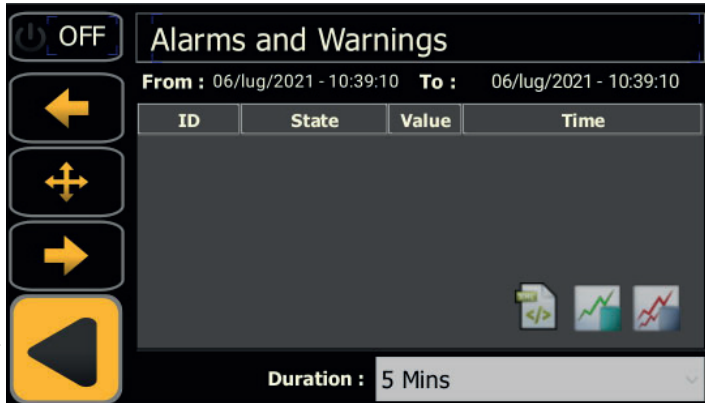

Quando sono state ripristinate le condizioni nominali di lavoro di avviso o allarme si resetta automaticamente, per altri allarmi/avvisi è necessario eseguire il reset manuale.

Toccare  per il reset allarme.

Toccare  per vedere lo storico allarmi con:

il codice dell'allarme, la data, il numero di allarmi, la posizione in sequenza di accadimento, e l'orario di attivazione allarme.

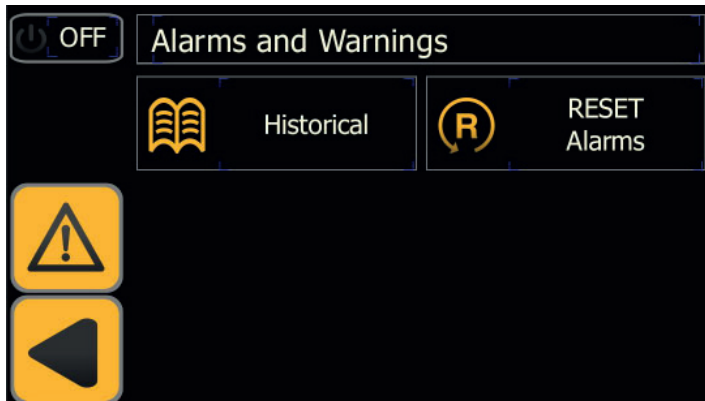

Toccare  per tornare al menu precedente.

5.3.1 Lista allarmi/avvisi

a = allarmi; w = avviso.

Codice	Allarme/Avviso	Causa
aLD	allarme basso dew point	temperatura B0<A9 per più di A10 secondi
aLT	allarme bassa temperatura di evaporazione	temperatura B2<A12 per più di A13 secondi
aHT2	allarme alta temperatura di mandata	temperatura B8>A11
aHP	allarme alta pressione	pressostato di alta è intervenuto
aLP	allarme bassa pressione	pressostato di bassa è intervenuto
aLTA	allarme bassa temperatura multicooter	temperatura B4<A12 per più di A13 seconds
aPI*	allarme protezione termica compressore	la protezione termica del compressore è intervenuta
aPH	allarme monitore di fase	il monitore di fase è intervenuto (solo per 460-750)
aCM1	allarme comunicazione espansione 1	l'espansione 1 non sta comunicando
aCM2	allarme comunicazione espansione 2	l'espansione 2 non sta comunicando
wB0	avviso sensore B0	senore rotto o non connesso
wB2	avviso sensore B2	senore rotto o non connesso
wB4	avviso sensore B4	senore rotto o non connesso
wB5	avviso sensore B5	senore rotto o non connesso
wB6	avviso sensore B6	senore rotto o non connesso
wB8	avviso sensore B8	senore rotto o non connesso
aFP1	allarme trasduttore alta pressione P1	trasduttore rotto o non connesso
wHD	avviso alto dew point	temperatura B0>A6 per più di A8 minuti
wHT1	avviso alta temperatura di mandata	temperatura B8>A14 per più di A15 minuti
wHP1	avviso di alta pressione sensore P1	pressione P1>A16 per più di 2 secondi
wHB5	avviso di alta temperatura in aspirazione	temperatura B5>A18 per più di 1 minuto
wLP2	avviso bassa pressione	pressione P2<A21 per più di 150 secondi
wSR	avviso manutenzione programmata	il tempo impostato di manutenzione è terminato
wDR1	avviso scaricatore 1	la condensa non si scarica dal essiccatore 1
wDR2	avviso scaricatore 2	la condensa non si scarica dal essiccatore 2
wDR3	avviso scaricatore 3	la condensa non si scarica dal essiccatore 3
aFP2	allarme bassa trasduttore pressione P2	trasduttore rotto o non connesso

* per i modelli dal 900-1800 l'allarme potrebbe avere anche il significato di fasi invertite.

5.4 Menu rapido

Raggiungere il menu in brevi passaggi:

View the temperature

Toccare  → Toccare  Toccare il campo di temperature per vedere i grafici.

View the pressure

Toccare  → Toccare  Toccare il campo di temperature per vedere i grafici.

Download

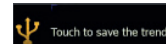
Toccare  → Toccare  per il download.

Serial number

Toccare  → Toccare 

Language

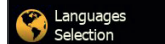
Toccare  → Toccare  → Toccare  scegliere la lingua.

Date/Time

Toccare  → Toccare  → Toccare  aggiornare orologio.

Cambio del'unita di misura da °C a °F, Remote, DEF

Toccare  → Toccare  → Toccare  → Toccare  :

Toccare il parametro "°C" o "°F" per fare il cambio.
Abilitare/disabilitare il parametror "Remote ON/OFF" .
Toccare "DEF" per ripristinare i parametri di default.

Switch to "cycling" operation

Toccare  → Toccare  → Toccare  → Toccare  cambia il funzionamento.

Drain

Toccare  → Toccare  → Toccare  → Toccare  scegli il tuo scaricatore di condensa.



Modbus

Toccare  → Toccare  → Toccare  → Toccare 

Setting Parameter

Toccare  → Toccare  → Toccare  → Toccare  cambia il parametro.

Alarm / warning

Toccare  → Toccare  per trovare "historical alarm" e "reset alarm".

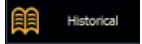
Toccare  per vedere il tuo storico allarmi.

Toccare  to resettare l'allarme.

6 Manutenzione

- La macchina è progettata e costruita per garantire un funzionamento continuativo; la durata dei suoi componenti è però direttamente legata alla manutenzione eseguita.
-  In caso di richiesta di assistenza o ricambi, identificare la macchina (modello e numero di serie) leggendo la targhetta di identificazione esterna all'unità.
- I circuiti contenenti 5t < xx < 50t di CO₂ devono essere controllati per individuare perdite almeno una volta all'anno.
I circuiti contenenti 50t < xx < 500t di CO₂ devono essere controllati per individuare perdite almeno una volta ogni sei mesi ((UE) N. 517/2014 art. 4.3.a, 4.3.b).
- Per le macchine contenenti 5t CO₂ o più, l'operatore deve tenere un registro in cui si riportano la quantità e il tipo di refrigerante utilizzato, le quantità eventualmente aggiunte e quelle recuperate durante le operazioni di manutenzione, di riparazione e di smaltimento definitivo ((UE) N. 517/2014 art. 6).

6.1 Avvertenze generali

-  Prima di qualsiasi manutenzione verificare che:
 - il circuito pneumatico non sia più sotto pressione;
 - l'essiccatore sia scollegato dalla rete elettrica.

 In caso di perdita di refrigerante contattare personale esperto ed autorizzato

 Utilizzare sempre ricambi originali del costruttore: pena l'esonero del costruttore da qualsiasi responsabilità sul malfunzionamento della macchina.

 La valvola Schrader è da utilizzare solo in caso di anomalo funzionamento della macchina: in caso contrario i danni provocati da errata carica di refrigerante non verranno riconosciuti in garanzia.

6.2 Refrigerante

Operazione di carica: eventuali danni provocati da errata carica refrigerante eseguita da personale non autorizzato non verranno riconosciuti in garanzia. 

 L'apparecchiatura contiene gas fluorurati a effetto serra.

Il fluido frigorifero R513A a temperatura e pressione normale è un gas incolore appartenente al SAFETY GROUP A1 - EN378 (fluido gruppo 2 secondo direttiva PED 2014/68/UE); GWP (Global Warming Potential) = 573.

 In caso di fuga di refrigerante aerare il locale.

6.3 Programma di manutenzione

Per garantire nel tempo la massima efficienza ed affidabilità dell'essiccatore eseguire:

Descrizione attività di manutenzione	Intervallo manutenzione (in condizioni di funzionamento standard)					
	Attività	Ogni giorno	Ogni settimana	Ogni 4 Mesi	Ogni 12 Mesi	Ogni 36 Mesi
Controllare che la spia POWER ON sia accesa.	Controllo  Service 					
Controllare gli indicatori del pannello di controllo.						
Pulire il filtro della valvola pressostatica se non è sporco aumentare l'intervallo di controllo (vedi istruzioni) (PSE750-1800)						
Controllare lo scaricatore di condensa.						
Pulire le alette del condensatore.						
Verificare il corretto posizionamento e funzionamento della resistenza carter						
Controllare l'assorbimento elettrico.						
Controllare le perdite di refrigerante						
Depressurizzare l'impianto. Eseguire la manutenzione dello scaricatore.						
Depressurizzare l'impianto. Sostituire gli elementi dei pre- e post-filtri.						
Controllare sonde temperature. Sostituire se necessario.				 		
Kit di manutenzione essiccatore.						



Sono disponibili (vedere paragrafo 8.4):

- kit manutenzione preventiva ogni 3 anni;
- kit service:
 - kit compressore;
 - kit ventilatore;
 - kit valvola gas caldo;
 - kit condensatore d'acqua;
- ricambi sciolti.

6.4 Smantellamento

Il fluido frigorifero e l'olio lubrificante contenuto nel circuito dovranno essere recuperati in conformità alle locali normative ambientali vigenti.

Il recupero del fluido refrigerante è effettuato prima della distruzione definitiva dell'apparecchiatura ((UE) N. 517/2014 art.8).

	Riciclaggio Smaltimento 
carpenteria	acciaio/resine epossidi-poliestere
scambiatore	alluminio
tubazioni/collettori	alluminio/rame
scaricatore	polyamide
isolamento scambiatore	EPS (polistirene sinterizzato)
isolamento tubazioni	gomma sintetica
compressore	acciaio/rame/alluminio/olio
condensatore	rame/alluminio
refrigerante	R513A
valvole	ottone
cavi elettrici	rame/PVC

Ai sensi dell' art.26 del Decreto Legislativo 14 marzo 2014 , n.49 .

Attuazione della Direttiva 2012/19/UE sui rifiuti di apparecchiature elettriche ed elettroniche (RAEE)" e dell' art.22 del Decreto Legislativo 188 del 20 novembre 2008 la raccolta differenziata della presente apparecchiatura professionale a fine vita è organizzata e gestita dal produttore nel caso in cui l'apparecchiatura sia stata immessa sul mercato dopo il 31 dicembre 2010 . Nel caso in cui vengano fornite all' utente apparecchiatura nuova equipollente si stabilisce il termine di 15 giorni dalla fornitura della stessa per esercitare il diritto di richiedere il ritiro da parte del produttore .



7 Ricerca guasti

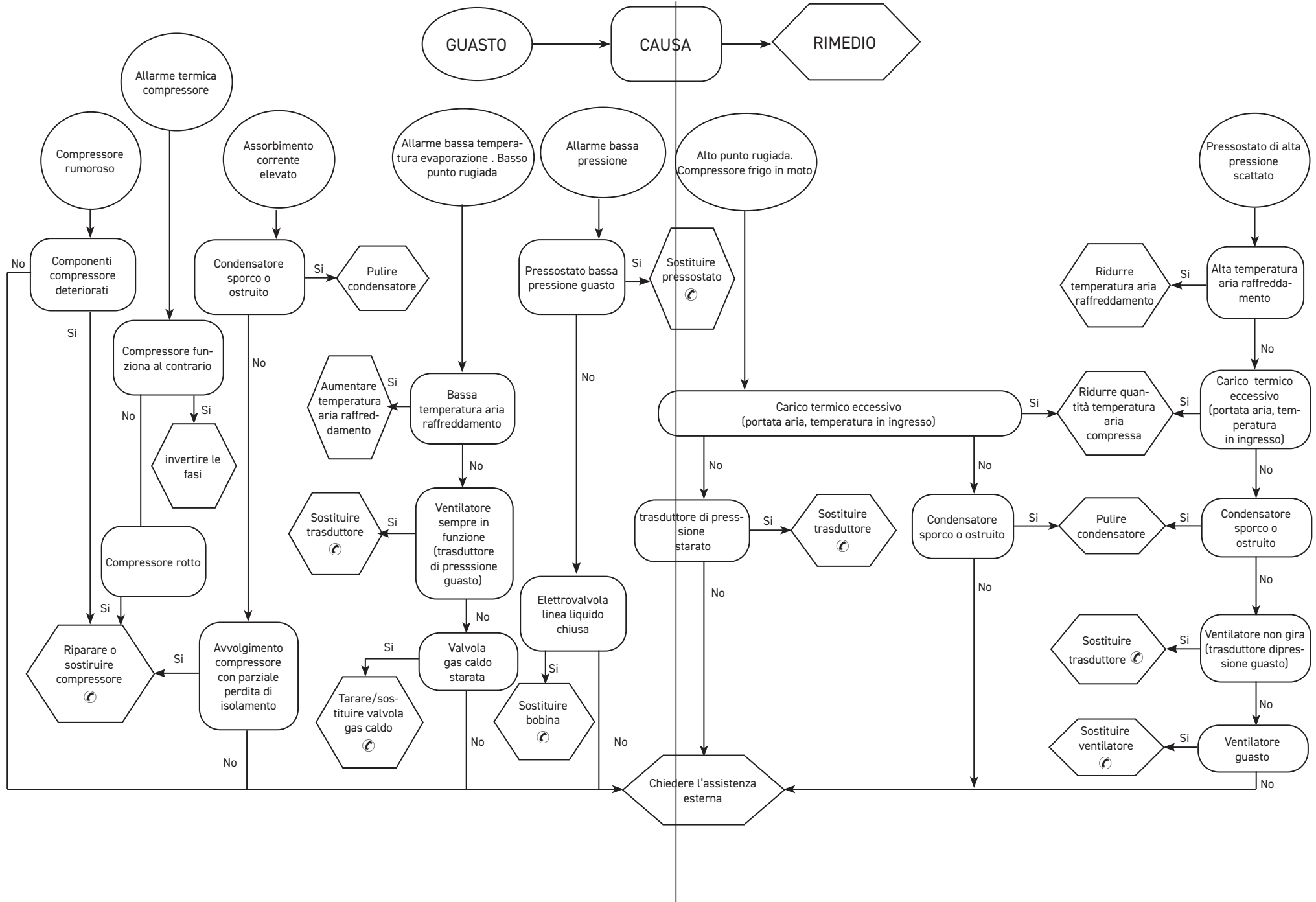

Index

1 Safety	1
1.1 Importance of the manual.....	1
1.2 Warning signals.....	1
1.3 Safety instructions.....	1
1.4 Residual risks.....	2
2 Introduction	2
2.1 Transportation.....	2
2.2 Handling.....	2
2.3 Inspection.....	2
2.4 Storage.....	2
3 Installation	3
3.1 Procedures.....	3
3.2 Operating space.....	3
3.3 Condenser version.....	3
3.4 Tips.....	3
3.5 Electrical connection.....	3
3.6 Condensate drain connection.....	3
4 Commissioning	4
4.1 Preliminary checks.....	4
4.2 Starting.....	4
4.3 Operation.....	4
4.4 Stop.....	4
5 Control	5
5.1 Control panel.....	5
5.2 Main menu.....	5
5.2.1 Machine status (I/O).....	5
5.2.2 Pressure.....	6
5.2.3 Temperature.....	6
5.2.4 Download.....	7
5.2.5 Serial number date.....	7
5.2.6 General.....	7
5.2.6.1 Language selection.....	7
5.2.6.2 Set Date/ Time.....	7
5.2.6.3 User menu.....	8
5.2.6.4 Parameters.....	8
5.3 Alarms/warnings.....	10
5.3.1 List of alarms/warnings.....	10
5.4 Rapid menu.....	11
6 Maintenance	12
6.1 General instructions.....	12
6.2 Refrigerant.....	12
6.3 Preventive Maintenance Programme.....	12
6.4 Dismantling.....	13
7 Troubleshooting	14
8 Appendix	

1 Safety

1.1 Importance of the manual

- Keep it for the entire life of the machine.
- Read it before any operation.
- It is subject to changes: for updated information see the version on the unit.

1.2 Warning signals



Instruction for avoiding danger to persons.



Instruction for avoiding damage to the equipment.



The presence of a skilled or authorized technician is required.



There are symbols whose meaning is given in the para. 8.1

1.3 Safety instructions

Every unit is equipped with an electric disconnecting switch for operating in safe conditions. Always use this device in order to eliminate risks maintenance.

The manual is intended for the end-user, only for operations performable with closed panels: operations requiring opening with tools must be carried out by skilled and qualified personnel.

Do not exceed the design limits given on the data plate.

It is the user's responsibility to avoid loads different from the internal static pressure. The unit must be appropriately protected whenever risks of seismic phenomena exist.

The safety devices on the compressed air circuit must be provided for by the user

The dimensioning of the safety devices of the air compressed circuit must be according to the specifications of the system and legislation in force locally.

Only use the unit for professional work and for its intended purpose.

The user is responsible for analyzing the application aspects for product installation, and following all the applicable industrial and safety standards and regulations contained in the product instruction manual or other documentation supplied with the unit.

Tampering or replacement of any parts by unauthorized personnel and/or improper machine use exonerate the manufacturer from all responsibility and invalidate the warranty.

The manufacturer declines present or future liability for damage to persons, things and the machine, due to negligence of the operators, non-compliance with all the instructions given in this manual, and non-application of current regulations regarding safety of the system.

The manufacturer declines any liability for damage due to alterations and/or changes to the packing.

It is the responsibility of the user to ensure that the specifications provided for the selection of the unit

or components and/or options are fully comprehensive for the correct or foreseeable use of the machine itself or its components.

 **IMPORTANT:** The manufacturer reserves the right to modify this manual at any time. The most comprehensive and updated information, the user is advised to consult the manufacturer.

1.4 Residual risks

The installation, start up, stopping and maintenance of the machine must be performed in accordance with the information and instructions given in the supplied technical documentation and always in such a way to avoid the creation of a hazardous situation. The risks that it has not been possible to eliminate in the design stage are listed in the following table:

Part affected	Residual risk	Manner of exposure	Precautions
heat exchanger coil	small cuts	contact	avoid contact, wear protective gloves
fan grill and fan	lesions	insertion of pointed objects through the grill while the fan is in operation	do not poke objects of any type through the fan grille or place any objects on the grill
inside the unit: compressor and discharge pipe	burns	contact	avoid contact, wear protective gloves
inside the unit: metal parts and electrical wires	intoxication, electrical shock, serious burns	defects in the insulation of the power supply lines upstream of the electrical panel; live metal parts	adequate electrical protection of the power supply line; ensure metal parts are properly connected to earth
outside the unit: area surrounding the unit	intoxication, serious burns	fire due to short circuit or overheating of the supply line upstream of the unit's electrical panel	ensure conductor cross-sectional areas and the supply line protection system conform to applicable regulations

2 Introduction

This manual is in reference to refrigeration dryers designed to remove water vapor from compressed air.

2.1 Transportation

The packed unit must:

- remain upright;
- be protected against atmospheric agents;
- be protected against impacts.

2.2 Handling

Use a fork-lift truck suitable for the weight to be lifted, avoiding any type of impact.

2.3 Inspection

- All the units are assembled, wired, charged with refrigerant and oil and tested under standard operating conditions in the factory;
- on receiving the machine check its condition: immediately notify the transport company in case of any damage;
- unpack the unit as close as possible to the place of installation.

2.4 Storage

If several units have to be stacked, follow the notes given on the packing. Keep the unit packed in a clean place protected from damp and bad weather.

3 Installation

☞ Install indoors in a clean, dry area that is protected from the elements, direct sunlight and/or other harsh conditions.

⚠ The product installed must be suitably protected against fire risk (Ref. EN378-3).

3.1 Procedures

Install the dryer inside, in a clean area protected from direct atmospheric agents (including sunlight).

⚠ Make sure to screw down the stud bolts in the flanges before connecting the counterflanges (see par. 8.6 appendix).

☞ Comply with the instructions given in par. 8.2 and 8.3).

All dryers must be fitted with adequate pre-filtration near the dryer air inlet. Seller is excluded any obligation of compensation or refund for any direct or indirect damage caused by its absence

☞ Pre-filter element (for 3 micron filtration or better) must be replaced at least once a year, or sooner as per manufacturer recommendations.

☞ Correctly connect the dryer to the compressed air inlet/outlet connections.

3.2 Operating space

Leave a space of 1.5 m around the unit.

Leave a space of 2 m above dryer models with vertical condensation air expulsion.

3.3 Condenser version

Air-cooled version (Ac)

Do not create cooling air recirculation situations. Do not obstruct the ventilation grilles.

Water-cooled version (Wc)

If not provided in the supply, fit a mesh filter on the condensation water inlet.

☞  Inlet condensation water characteristics:

Temperature	≥50°F (10°C)	CL ⁻	<50 ppm
ΔT IN/OUT	5-15°C	CaCO ₃	70-150 ppm
Max % glycol	50	O ₂	<0.1 ppm
Pressure	(3-10 barg)	Fe	<0.2 ppm
PH	7.5-9	NO ₃	<2 ppm
Electrical conductivity	10-500 μS/cm	HCO ₃ ⁻	70-300 ppm
Langelier saturation index	0-1	H ₂ S	<0.05 ppm
SO ₄ ²⁻	<50 ppm	CO ₂	<5 ppm
NH ₃	<1 ppm	Al	<0.2 ppm

Please note that for special cooling water types such as demineralized, deionized or distilled it is necessary to contact the manufacturer to verify which kind of condenser should be used since the standard material may not be suitable.

3.4 Tips

To prevent damage to the internal parts of the dryer and air compressor, avoid installations where the surrounding air contains solid and/or gaseous pollutants (e.g. sulphur, ammonia, chlorine and installations in marine environments).

The ducting of extracted air is to be avoided for versions with axial fans

3.5 Electrical connection

Use approved cable in conformity with the local laws and regulations (for minimum cable section, see par. 8.3

Install a differential thermal magnetic circuit breaker with contact opening distance 3 mm ahead of the system (RCCB - IDn = 0.3A) (see the relevant current local regulations).

The nominal current In of the magnetic circuit breaker must be equal to the FLA with an intervention curve type D.

Select the power supply and insert a bridge as shown below:

S7-S6 for 400/3/50

S8-S6 for 460/3/60

Inside the electrical panel there is an instruction label.

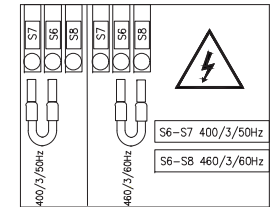

3.6 Condensate drain connection

☞ Make the connection to the draining system, avoiding connection in a closed circuit shared by other pressurized discharge lines. Check the correct flow of condensate discharges. Dispose of all the condensate in conformity with current local environmental regulations.

4 Commissioning

4.1 Preliminary checks

Before commissioning the dryer, make sure:

- installation was carried out according that given in the section 3;
- the air inlet valves are closed and that there is no air flow through the dryer;
- the power supply is correct;
- with Wc version, open the cooling water circuit a few minutes before starting the dryer.

4.2 Starting

1. switch the power on by turning the "MAIN SWITCH "



" to "I ON": appear this information:

THE CRANKCASE HEATER MUST BE SWITCHED ON 12 HOURS BEFORE STARTING THE DRYER.

After, touch to enter on the control panel.



2. Touch to start, the button changes the color from grey to green, to signal that the dryer is

now in operation .

3. Start the dryer before the air compressor;

Failure to comply with this rule may cause serious damage to the compressor.

Fan (Ac version): if connected with the wrong phase sequence they turn in the opposite direction, with the risk of being damaged (in this case the air exits the dryer cabinet from the condenser grilles instead from the fan grille - see par. 8.6/8.7 (appendix) for correct air flow); immediately invert two phases.

4. Wait 5 minutes, then slowly open the air inlet valve;

5. slowly open the air outlet valve: the dryer is now drying.

Phases Monitor

If appears to display the alarm "phase monitor ", during the start up of the dryer, the user must verify the wiring of the input terminals of the disconnecting switch of the dryer.

4.3 Operation

- Leave the dryer on during the entire period the air compressor is working;
- The dryer operates in automatic mode, therefore field settings are not required;
- In the event of unforeseen excess air flows, by-pass to avoid overloading the dryer.
- Avoid inlet air temperature fluctuations.

4.4 Stop

1. Stop the dryer 2 minutes after the air compressor stops or in any case after interruption of the air flow;
2. make sure compressed air does not enter the dryer when the dryer is disconnected or if an alarm occurs.



3. Press to switch off the dryer. The button changes the color in grey



4. Turn the MAIN SWITCH " " to "O OFF" to switch the power off.



Wc version, close the water circuit with the dryer stopped.

	EN - THE CRANKCASE HEATER MUST BE SWITCHED ON 12 HOURS BEFORE STARTING THE DRYER.
	IT - LA RESISTENZA CARTER DEVE ESSERE INSERITA 12 ORE PRIMA DI AVVIARE L'ESSICCATORE.
	FR - LA RESISTANCE CARTER DOIT ETRE BRANCHEE 12 HEURES AVANT LA MISE EN MARCHÉ DU SECHÉUR.
	DE - DIE VERSORGUNG DER KURBELWANNENHEIZUNG IST 12 STUNDEN VOR DER EINSCHALTUNG DES TROCKNERS FREIZUGEBEN.

5 Control

5.1 Control panel

25/giu/2021 - 11:04:39

LOCAL [Power Off] [Info] [Warning]

FS 0% HGBV 0% ECO 0%

0.0 °C PDP

MANUAL DRAIN

Touch buttons	Function
[Power Off] LOCAL	Dryer OFF (Black)
[Power On] LOCAL	Dryer ON (Green)

LOCAL = Local configuration
REMOTE = Remote configuration

Function	Touch buttons	Function
<p>FS 48 %</p> <p>Fan operation rate(only for air condenser version)</p>	[Info]	Access to information menu: machine status, pressures, temperatures, general settings, consumption, user password
<p>HGBV 14 %</p> <p>Hot gas valve operation rate</p>	[Warning]	Gray = no alarm Red = warning Flashing Red = Alarm
<p>ECO 0%</p> <p>Energy saving %(cycling)</p>	[Snowflake]	Dryer OFF = grey light Cycling active = flashing green Compressor active = light blue
	[Water Drop]	grey = Condensate drain OFF green = Condensate drain ON

Function	Touch buttons	Function							
<p>8.0 °C PDP</p> <p>Dew point trend</p>	MANUAL DRAIN [Water Drop]	Touch: for a manual drain							
		<table border="1"> <thead> <tr> <th>Function</th> </tr> </thead> <tbody> <tr> <td></td> <td>Strep led: blu = Compressor active</td> </tr> <tr> <td></td> <td>green = energy saving</td> </tr> <tr> <td></td> <td>red = alarm</td> </tr> </tbody> </table>	Function		Strep led: blu = Compressor active		green = energy saving		red = alarm
Function									
	Strep led: blu = Compressor active								
	green = energy saving								
	red = alarm								

5.2 Main menu

Touch [Info] to enter on "Information" menu.

When one of the "touch buttons" is touched, for a few seconds the outline lights up to confirm that the selection has been made.

This is for each "touch button" present on the control panel.

Touch [Back] to return to control panel.

[OFF]	Temperatures	Pressures
[Info]	Status of I/O	Serial Number
[Warning]	USB Save data	
[Back]	General setting	

5.2.1 Machine status (I/O)

Touch [Status of I/O] to enter on "machine status" menu.

This is the list of inputs:

A led, close the description, indicates if the protections / functions / configurations is: active = green light no active = grey light. e.g .

Touch [Back] to enter on the next page.

Function	Touch buttons	Function
<p>Status of Input</p> <ul style="list-style-type: none"> High pressure switch Low pressure switch Thermal protection compressor Thermal protection fan Phases sequence control Dryer remote control Condensate level 1 Condensate level 2 Condensate level 3 	[Back]	

This is the list of outputs:

Touch [Back] to return to the previous menu.



Function	Touch buttons	Function
<p>Status of Output</p> <ul style="list-style-type: none"> Plant status ON General Alarm Compressor ON Fan ON Liquid solenoid valve Condensate drain 1 Condensate drain 2 Condensate drain 3 	[Back]	

5.2.2 Pressure

Touch  to enter on "pressure" menu to visualize: condensing pressure, fan operating rate, evaporating pressure, hot gas valve operating rate.



Touch a specific parameter to view its data trend of performance over time. e.g.

"Condensing/Evaporating pressure"

use  and  to scroll on the graph.

Touch  to the previous menu.

"Hot gas valve/fan operating rate"

use  and  to scroll on the graph.

Touch  to the previous menu.

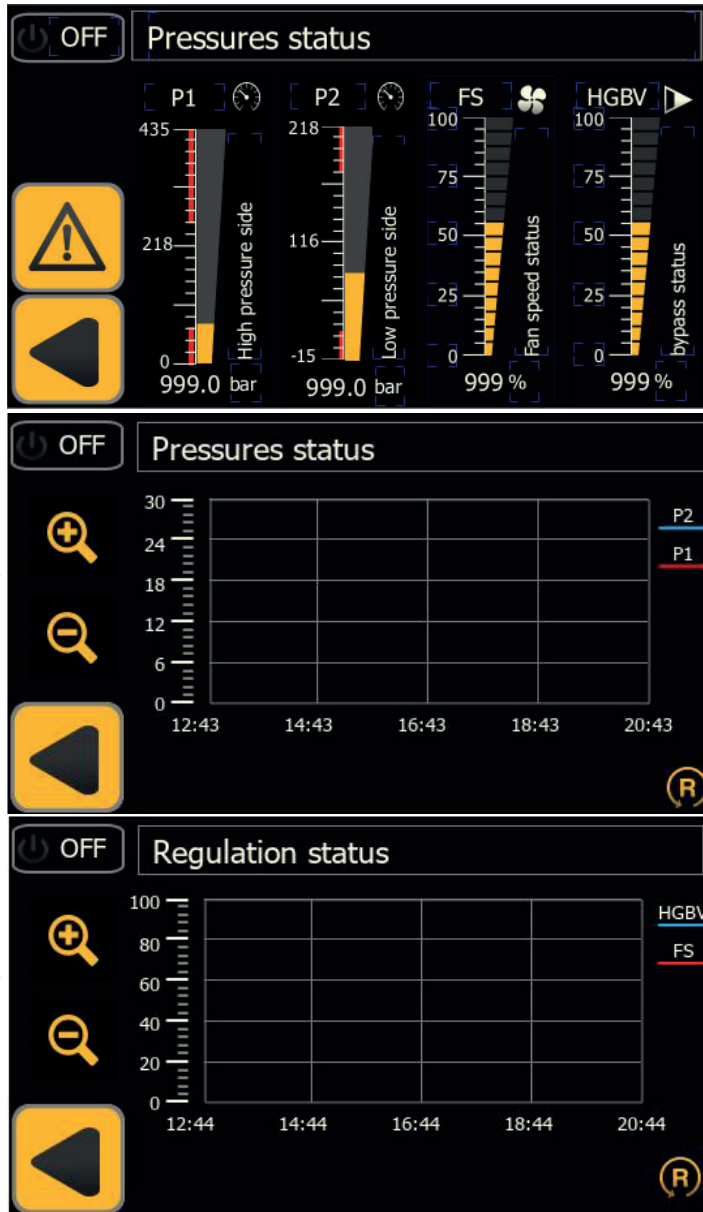

5.2.3 Temperature

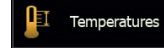
Touch  to visualize temperature readings by the temperature probes of the circuit diagram.



touch  to enter on the next page.

B4 = active only for multicooler version

Touch one of the low pressure temperatures values to see a data trend of all the probes in the low pressure circuit.



Touch one of the high pressure temperature values to see a data trend of all the probes in the high pressure circuit

Temperature - Low pressure side

use  and  to scroll on the graph.

Touch  to the previous menu.

Temperature - High pressure side

use  and  to scroll on the graph.

Touch  to the previous menu.

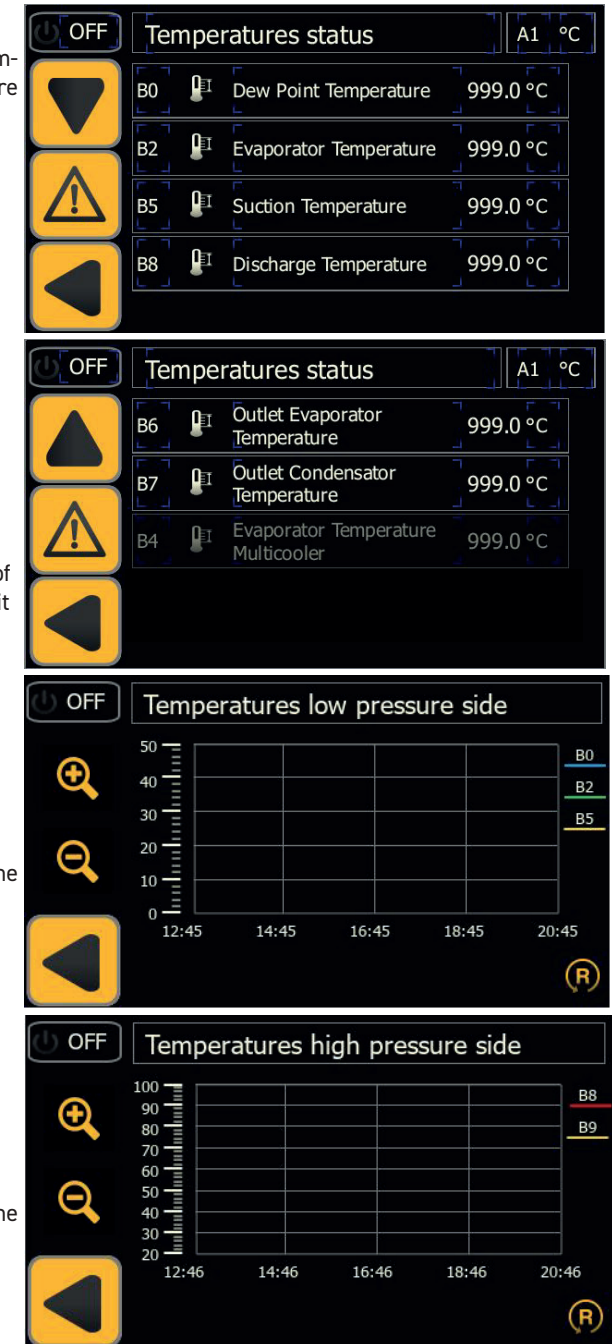

5.2.4 Download

Use a USB with led , that show you the downloading phase. (8gB formatted as FAT32) insert into the front panel.



Touch  to start the download.

The data download time depends on the amount of data stored.

5.2.5 Serial number date

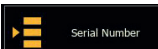
Touch  to enter on "serial number date" window.

Touch  to return to control panel.

5.2.6 General

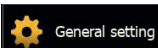
Touch  to enter on "general" menu with the following section: language; date/hour; parameter ; maintenance; cycling/continuous operating.

Touch any menu to view/adjust.

Touch  to return to the control panel.

5.2.6.1 Language selection

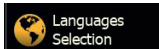
Touch  to enter on language menu. Touch the language you need. Automatically you return to the main menu with the chosen language.

Touch  to the previous menu.

Touch the language you need. Automatically you return to the main menu with the chosen language.

Touch  to the previous menu.

5.2.6.2 Set Date/Time

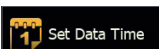
Touch  to enter on "date/Hour" menu. Set time and date to proceed with the change.

Press for 2 seconds

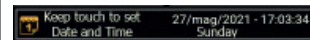

to confirm.

Touch  to return to the previous menu.

5.2.6.3 User menu

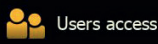
Touch  to enter on "User" menu.

This menu is reserved for Parker service technician.

User name:

Password:

Show password

5.2.6.4 Parameters

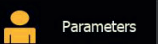
Touch  to enter on "parameter" menu with the following sections: probes, condensate drain, configuration, maintenance, cycle.

Touch the "button touch" to enter on menu.

Touch  to return to the previous menu.

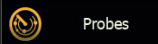

Probes

Touch  to set the warnings and delays or the minimum/maximum of dew point.

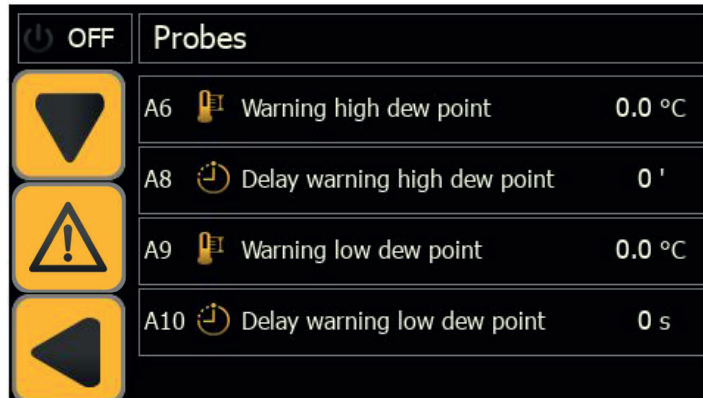

Condensate drain

Touch  to enter on the menu "condensate drain" to choose:

1. timed drain (choosing the closing and opening times);
2. capacitive drain;
3. continuous drain (external drain).

Touch  to the previous menu.

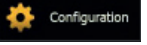

Configuration

Touch  to enter on configuration display with the following menu:

1. Unit of measure C° / F°;
2. Enabling remote control;
3. Enabling only alarms or alarms / warnings;
4. Reset the settings with the default parameters.

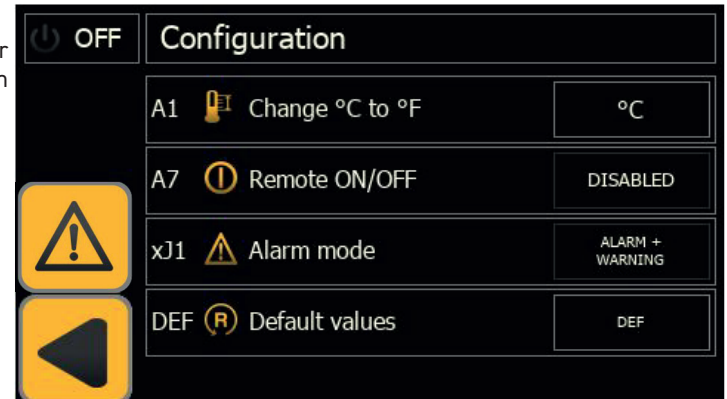

use the "button touch" close to the description to make your choice.

 To manage REMOTE OFF mode, remove the bridge between terminals: 87-92, and connect the remote start/stop switch (to be provided for by the customer).

Maintenance

Touch  to see the work hours compressor/dryer.

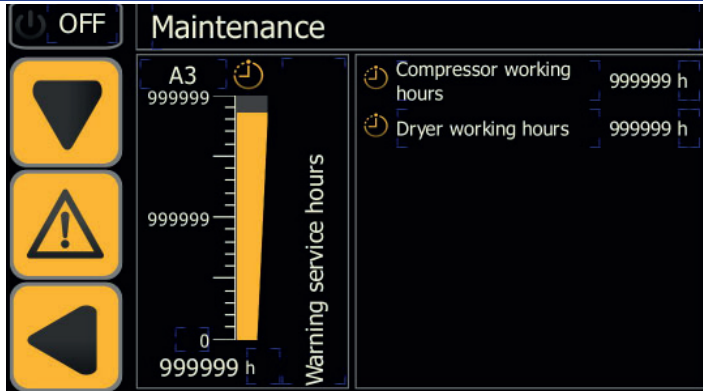

The Maintenance screen features a power button labeled 'OFF' at the top left. Below it is a vertical bar chart for 'Warming service hours' with a scale from 0 to 999999 h. To the right, two rows show 'Compressor working hours' and 'Dryer working hours', both set to 999999 h. On the left side, there are three navigation buttons: a downward arrow, a warning triangle, and an upward arrow.

Touch  to the previous menu.

Operating

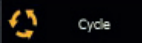
Touch  to choose the type of operating : continuous; cycling (energy saving).

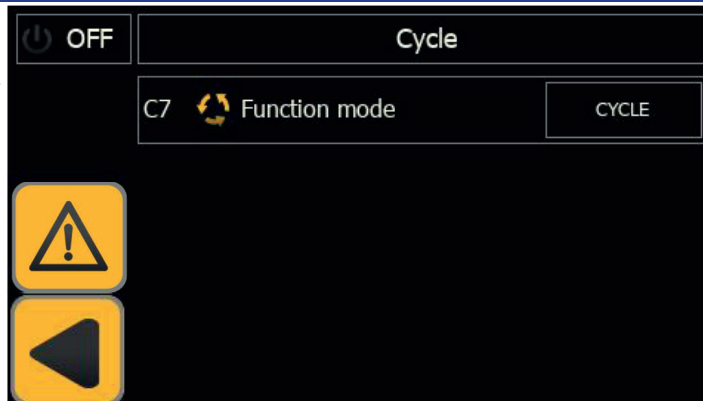

The Operating screen has a power button labeled 'OFF' at the top left. The main display shows 'C7 Function mode' with a 'CYCLE' button to its right. On the left side, there are two navigation buttons: a warning triangle and an upward arrow.

Touch the parameter to make adjustment

Touch  to the previous menu.

Modbus

Touch  to set Modbus parameters.
MODBUS RTU (RS485)

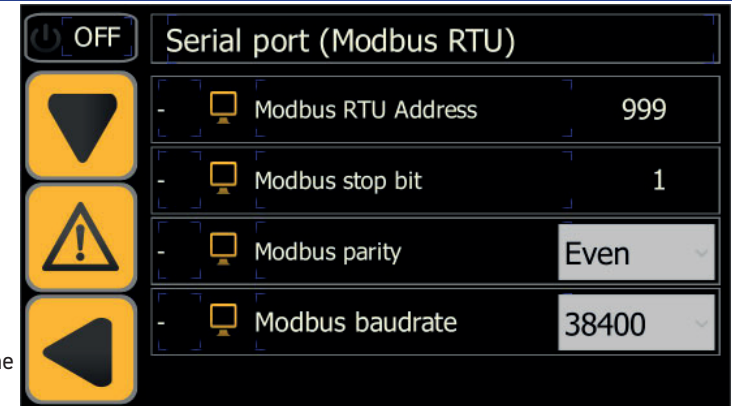

The Serial port (Modbus RTU) screen has a power button labeled 'OFF' at the top left. It contains four rows of configuration options: 'Modbus RTU Address' (999), 'Modbus stop bit' (1), 'Modbus parity' (Even), and 'Modbus baudrate' (38400). On the left side, there are three navigation buttons: a downward arrow, a warning triangle, and an upward arrow.

touch  to enter on the next page.

MODBUS TCP/IP

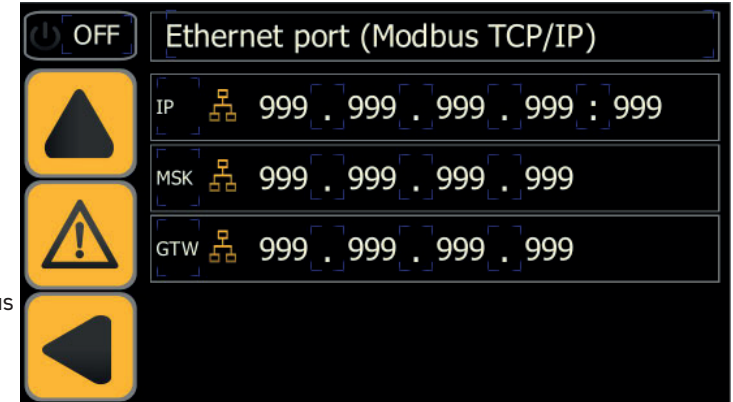

The Ethernet port (Modbus TCP/IP) screen has a power button labeled 'OFF' at the top left. It contains three rows of configuration options: 'IP' (999 . 999 . 999 . 999 : 999), 'MSK' (999 . 999 . 999 . 999), and 'GTW' (999 . 999 . 999 . 999). On the left side, there are three navigation buttons: a warning triangle, a warning triangle, and an upward arrow.

Touch  to the previous menu.

Switch OFF/Switch ON the dryer to confirm the configuration.

Cloud

Touch  to see "password" to cloud.

This option is on going.



The Cloud Licence screen has a power button labeled 'OFF' at the top left. It features a password field containing the value '99999'. On the left side, there are two navigation buttons: a warning triangle and an upward arrow.

Touch  to the previous menu.

5.3 Alarms/warnings

Touch  to enter on "alarms/warning" or "alarm" menu:

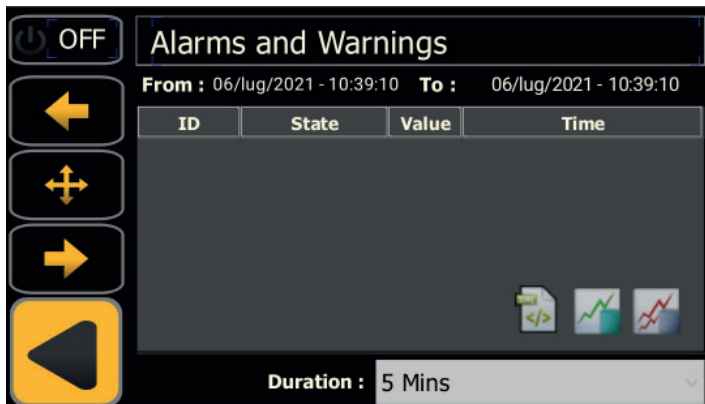

Touch "duration" to change the time of reserch.

When the nominal working conditions have been restored, some warning and alarm are automatically reset, for other alarms/warning it is necessary to perform a manual reset.

Touch  to reset the alarms.

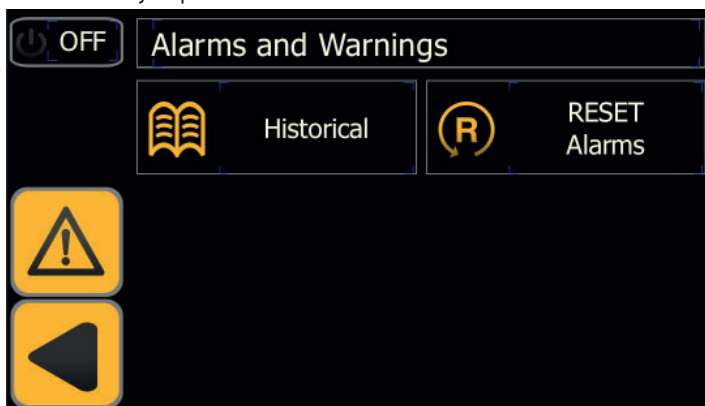

Touch  to visualize the historical alarms with:

the alarm code, the date, the number of alarms, the position in the sequence of occurrence, and the alarm activation time.

Touch  to the previous menu.

5.3.1 List of alarms/warnings

a = alarm; w = warning.

Code	Alarm/Warning	Cause
aLD	low dew point alarm	temperature B0<A9 for more than A10 seconds.
aLT	low evaporator temperature alarm	temperature B2<A12 for more than A13 seconds
aHT2	high discharge temperature alarm	temperaure B8>A11
aHP	high pressure alarm	high pressure switch is tripped
aLP	low pressure alarm	low pressure switch is tripped
aLTA	low multicooter temperature alarm	temperature B4<A12 for more than A13 seconds
aPI*	Compressor thermal protection alarm	Compressor thermal protection is tripped
aPH	phase monitoring alarm	phase monitoring relay is tripped (only for 460-750)
aCM1	communication expansion 1 alarm	the expansion 1 is not communicating
aCM2	communication expansion 2 alarm	the expansion 2 is not communicating
wB0	warning probe B0	probe broken or not connected
wB2	warning probe B2	probe broken or not connected
wB4	warning probe B4	probe broken or not connected
wB5	warning probe B5	probe broken or not connected
wB6	warning probe B6	probe broken or not connected
wB8	warning probe B8	probe broken or not connected
aFP1	high pressure transmitter P1 alarm	transmitter broken or not connected
wHD	high dew point warning	temperature B0>A6 for more than A8 minutes
wHT1	high discharge temperature warning	temperature B8>A14 for more than A15 minutes
wHP1	high pressure warning	pressure P1>A16 for more than 2 seconds
wHB5	high suction temperature warning	temperture B5>A18 for more than 1 minute
wLP2	low pressure warning	pressure P2<A21 for more than 150 seconds
wSR	Scheduled maintenance warning	the service time is elapsed
wDR1	drain 1 warning	the condensate is not discharge from cooler 1
wDR2	drain 2 warning	the condensate is not discharge from cooler 2
wDR3	drain 3 warning	the condensate is not discharge from cooler 3
aFP2	low pressure transmitter P2 alarm	transmitter broken or not connected

* for models from 900-1800 the alarm could also have the meaning of inverted phases.

5.4 Rapid menu

Reach the menu in short steps:

View the temperature

Touch  → Touch  Touch the temperature to see the graphs.

View the pressure

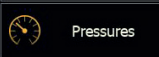
Touch  → Touch  Touch the pressure to see the graphs.

Download

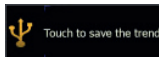
Touch  → Touch  for the download.



Serial number

Touch  → Touch  .

Language

Touch  → Touch  → Touch  choose your language.

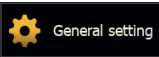
Date/Time

Touch  → Touch  → Touch  update clock.

Change of measurement unit from °C to °F, Remote, DEF



Touch  → Touch  → Touch  → Touch  :

Touch the parameter “**C**” or “**F**” for make the change.

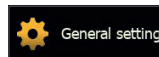

Enable / disable the parameter “**Remote ON/OFF**” .

Touch “**DEF**” to restore the parameter.

Switch to “cycling” operation

Touch  → Touch  → Touch  → Touch  change the operation.

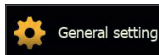
Drain

Touch  → Touch  → Touch  → Touch  choose your drain.

Modbus

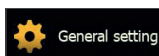
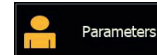

Touch  → Touch  → Touch  → Touch 

Setting Parameter

Touch  → Touch  → Touch  → Touch  change the

parameter.

Alarm / warning

Touch  → Touch  to find historical alarm and reset alarm

Touch  to see your historical alarm.

Touch  to reset alarm.

6 Maintenance

- The machine is designed and built to guarantee continuous operation; however, the life of its components depends on the maintenance performed.
- When requesting assistance or spare parts, identify the machine (model and serial number) by reading the data plate located on the unit.
- Circuits containing 5t < xx < 50t of CO₂ must be checked annually to identify any potential leaks. Per European Regulation EU No. 517/2014 art. 4.3.a, 4.3.b)
 - Circuits containing 50t < xx < 50t of CO₂ must be checked for leaks every 6 months.
- Per European Regulation EU No. 517/2014 art. 6 - Machines containing 5t CO₂ or more, the operator must keep a written record of the quantity and type of refrigerant used, added or recovered during maintenance/repair and final disposal.

6.1 General instructions

-  Before any maintenance, make sure:
- the pneumatic circuit is no longer pressurized;
 - the dryer is disconnected from the main power supply

 In case of refrigerant leakage, contact qualified and authorized personnel.

 Always use the Manufacturer's original spare parts: otherwise the Manufacturer is relieved of all liability regarding machine malfunctioning.

 The Schrader valve must only be used in case of machine malfunction: otherwise any damage caused by incorrect refrigerant charging will not be covered by the warranty.

6.2 Refrigerant

Charging: any damage caused by incorrect refrigerant replacement carried out by unauthorized personnel will not be covered by the warranty. 















 The equipment contains fluorinated greenhouse gases.

At normal temperature and pressure, the R513A refrigerant is a colourless gas classified in SAFETY GROUP A1 - EN378 (group 2 fluid according to Directive PED 2014/68/EU) GWP (Global Warming Potential) = 573.

 In case of refrigerant leakage, ventilate the room.

6.3 Preventive Maintenance Programme

To guarantee lasting maximum dryer efficiency and reliability:

Maintenance Activity Description	Maintenance Interval (standard operating conditions)				
	Daily	Weekly	4 Months	12 Months	36 Months
Activity					
Check  Service 					
Check POWER ON indicator is lit.					
Check control panel indicators.					
Clean the pressostatic valve filter, if it is not dirty increase the inspection interval (see instructions) (PSE750-1800)					
Check condensate drain.					
Clean condenser fins.					
Verify the correct position and operation of the crankcase heater					
Check electrical absorption.					
Check refrigerant leaks.					
Depressurize the dryer. Complete drain maintenance.					
Depressurize the dryer. Replace pre- and post-filter elements.					
Check temperature sensors. Replace if necessary.				 	
Dryer maintenance kit.					



The following are available (see par. 8.4 appendix):

- 3 years preventive maintenance kits;
- service kit
 - compressor kits;
 - fan kits;
 - hot gas valve kits;
 - water condenser kits;
- individual spare parts.

6.4 Dismantling

The refrigerant and the lubricating oil contained in the circuit must be recovered in conformity with current local environmental regulations.

The refrigerant fluid is recovered before final scrapping of the equipment ((EU) No. 517/2014 art.8).

	Recycling Disposal 
structural work	steel/epoxy-polyester resins
exchanger	aluminium
pipes/headers	copper/aluminium/carbon steel
drain	polyamide
exchanger insulation	EPS (sintered polystyrene)
pipe insulation	synthetic rubber
compressor	steel/copper/aluminium/oil
condenser	copper/aluminium
refrigerant	R513A
valves	brass
electrical cables	copper/PVC

Equipment containing electrical components must be disposed separately collected with electrical and electronic waste according to local and currently legislation.



7 Troubleshooting

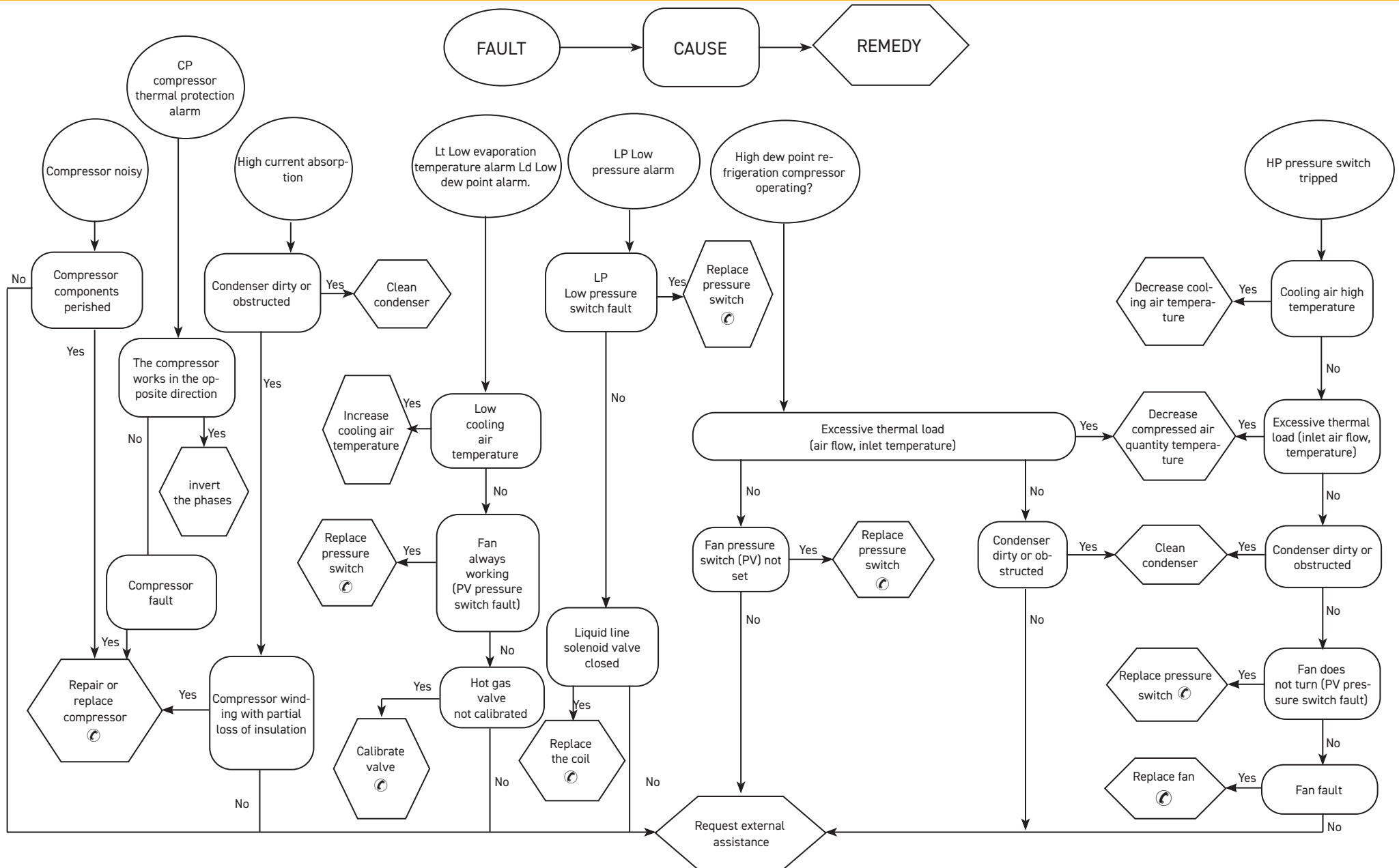

Índice

1 Seguridad	1
1.1 Importancia del manual.....	1
1.2 Señales de advertencia.....	1
1.3 Instrucciones de seguridad.....	1
1.4 Riesgos residuales.....	2
2 Introducción	2
2.1 Transporte.....	2
2.2 Traslado.....	2
2.3 Inspección.....	2
2.4 Almacenaje.....	2
3 Instalación	3
3.1 Modalidades.....	3
3.2 Espacio operativo.....	3
3.3 Versión condensador.....	3
3.4 Consejos.....	3
3.5 Conexión eléctrica.....	3
3.6 Conexión del drenaje de condensados.....	3
4 Puesta en Marcha	4
4.1 Comprobaciones previas.....	4
4.2 Arranque.....	4
4.3 Funcionamiento.....	4
4.4 Parada.....	4
5 Control	5
5.1 Panel de control.....	5
5.2 Menú principal.....	5
5.2.1 Estado del aparato (I/O).....	5
5.2.2 Presión.....	6
5.2.3 Temperatura.....	6
5.2.4 Download.....	7
5.2.5 Fecha del número de serie.....	7
5.2.6 General.....	7
5.2.6.1 Idioma.....	7
5.2.6.2 Fecha/Tiempo.....	7
5.2.6.3 User menu.....	8
5.2.6.4 Parámetro.....	8
5.3 Alarmas/advertencias.....	10
5.3.1 Lista de alarmas y avisos.....	10
5.4 Menú rápido.....	11
6 Mantenimiento	12
6.1 Advertencias generales.....	12
6.2 Refrigerante.....	12
6.3 Programa de mantenimiento preventivo.....	12
6.4 Desguace.....	13
7 Solución de problemas	14
8 Apéndice	

1 Seguridad

1.1 Importancia del manual

- Consérvelo durante toda la vida útil del equipo.
- Léalo antes de realizar cualquier operación.
- Puede sufrir modificaciones: para una información actualizada, consulte la versión instalada en el equipo.

1.2 Señales de advertencia



Instrucción para evitar peligros personales



Instrucción para evitar que se dañe el equipo



Se requiere la intervención de un técnico experto y autorizado



El significado de los símbolos utilizados se indica en el apartado 8.1

1.3 Instrucciones de seguridad

- Antes de realizar cualquier operación de mantenimiento, desconecte siempre la máquina de la red eléctrica. Utilícelo siempre durante el mantenimiento.
- El manual está destinado al usuario final y sólo para las operaciones que pueden realizarse con los paneles cerrados. Las operaciones que requieren la apertura con herramientas deben ser efectuadas por personal experto y calificado.
- No supere los límites de proyecto que se indican en la placa de características.
- El usuario debe evitar cargas distintas de la presión estática interna. En caso de riesgo de fenómenos sísmicos, es necesario proteger adecuadamente la unidad.
- Los dispositivos de seguridad en el circuito de aire comprimido están a cargo del usuario.
- Los dispositivos de seguridad del circuito del aire comprimido se dimensionan teniendo en cuenta las características técnicas del sistema y las normas locales en vigor. La unidad debe utilizarse exclusivamente para uso profesional y con el objeto para el cual ha sido diseñada. El usuario debe analizar todos los aspectos de la aplicación en que el producto se ha instalado, seguir todas las normas industriales de seguridad aplicables y todas las prescripciones relativas al producto descritas en el manual de uso y en la documentación redactada que se adjunta a la unidad.

La alteración o sustitución de cualquier componente por parte del personal no autorizado, así como el uso inadecuado de la unidad eximen de toda responsabilidad al fabricante y provocan la anulación de la garantía.

El fabricante declina toda responsabilidad presente o futura por daños personales o materiales derivados de negligencia del personal, incumplimiento de las instrucciones dadas en este manual o inobservancia de las normativas vigentes sobre la seguridad de la instalación.

El fabricante no asume ninguna responsabilidad por daños debidos a alteraciones y/o modificaciones del embalaje.

El usuario es responsable que las especificaciones suministradas para seleccionar la unidad o sus componentes y/o opciones sean exhaustivas para un uso correcto o razonablemente previsible de la misma unidad o de los componentes.

 **ATENCIÓN:** El fabricante se reserva el derecho de modificar sin previo aviso la información de este manual. Para que la información resulte completa, se recomienda al usuario consultar el fabricante.

1.4 Riesgos residuales

Las operaciones de instalación, puesta en marcha, apagado y mantenimiento del equipo deben realizarse de total conformidad con lo indicado en la documentación técnica del equipo y de manera tal que no se genere ninguna situación de riesgo. Los riesgos que no han podido eliminarse con recursos técnicos de diseño se indican en la tabla siguiente

parte del equipo	riesgo residual	modo	precauciones
batería de intercambio térmico	pequeñas heridas cortantes	contacto	evitar el contacto, usar guantes de protección
rejilla del ventilador y ventilador	lesiones	introducción de objetos puntiagudos en la rejilla mientras el ventilador está funcionando	no introducir ni apoyar ningún objeto en la rejilla de los ventiladores
interior del equipo: compresor y tubo de salida	quemaduras	contacto	evitar el contacto, usar guantes de protección
interior del equipo: partes metálicas y cables eléctricos	intoxicación, electrocución, quemaduras graves	defecto de aislamiento de los cables de alimentación que llegan al cuadro eléctrico del equipo; partes metálicas en tensión	protección eléctrica adecuada de la línea de alimentación; conectar cuidadosamente a tierra las partes metálicas
exterior del equipo: zona circundante	intoxicación, quemaduras graves	incendio por cortocircuito o sobrecalentamiento de la línea de alimentación del cuadro eléctrico del equipo	sección de los cables y sistema de protección de la línea de alimentación eléctrica conformes a las normas vigentes

2 Introducción

Este manual hace referencia a los secadores frigoríficos diseñados para eliminar el vapor de agua del aire comprimido.

2.1 Transporte

El equipo embalado debe mantenerse:

- en posición vertical;
- protegido de los agentes atmosféricos;
- protegido de golpes.

2.2 Traslado

Utilice una carretilla elevadora con horquillas, adecuada para el peso del equipo, y evite todo tipo de golpes.

2.3 Inspección

- Los equipos salen de fábrica ensamblados, cableados, cargados con refrigerante y aceite, y probados en las condiciones de trabajo nominales.
- Controle el equipo a su llegada y notifique inmediatamente al transportista si nota algún inconveniente.
- Desembale el equipo lo más cerca posible del lugar de instalación.

2.4 Almacenaje

Si es necesario apilar varios equipos, respete las indicaciones impresas en el embalaje. Conserve el equipo en un lugar limpio y protegido de la humedad y la intemperie.

3 Instalación

☞ Instale en interiores en un área limpia y seca que esté protegida de los elementos, la luz solar directa y / u otras condiciones adversas.

⚠ El producto instalado debe estar adecuadamente protegido contra el riesgo de incendio (ref. EN378-3).

3.1 Modalidades

⚠ En los modelos enrosque a tope los prisioneros en las bridas antes de montar las contrabridas (vea el apartado 8.6)

☞ Respete las indicaciones dadas en los apartados 8.2 y 8.3.
Todos los secadores deben contar con una adecuada prefiltración instalada cerca de la entrada de aire del secador. El vendedor no tendrá ninguna responsabilidad ni obligación de compensación por daño directo o indirecto causado por la ausencia de prefiltración adecuada

☞ El elemento de prefiltro (para filtración de 3 micrones o mejor) debe ser sustituido al menos una vez al año o antes, según las recomendaciones del fabricante.

☞ Conecte correctamente el secador utilizando las bocas de entrada y salida del aire comprimido.

3.2 Espacio operativo

☞ Deje un espacio libre de 1.5 m todo alrededor del equipo.
En los modelos con expulsión vertical del aire de condensación, deje 2 m libres sobre el secador.

3.3 Versión condensador

Versión por aire (Ac)

No cree situaciones que permitan la recirculación del aire de enfriamiento.
No obstruya las rejillas de ventilación.

Versión por agua (Wc)

Si el suministro no lo incluye, instale un filtro de malla en la entrada del agua de condensación.

☞ Características del agua de condensación utilizada

Temperatura	≥50°F (10°C)	CL ⁻	<50 ppm
ΔT IN/OUT	5-15°C	CaCO ₃	70-150 ppm
Max % de glicol	50	O ₂	<0.1 ppm
Presión	43.5-145 PSig (3-10 barg)	Fe	<0.2 ppm
PH	7.5-9	NO ₃	<2 ppm
Conductividad eléctrica	10-500 μS/cm	HCO ₃ ⁻	70-300 ppm
Índice de saturación de Langelier	0-1	H ₂ S	<0.05 ppm
SO ₄ ²⁻	<50 ppm	CO ₂	<5 ppm
NH ₃	<1 ppm	Al	<0.2 ppm

Es posible que los materiales estándar previstos para el condensador no sean adecuados para determinadas aguas de refrigeración (desionizada, desmineralizada, destilada). En estos casos, se ruega ponerse en contacto con el fabricante.

3.4 Consejos

A fin de proteger los componentes internos del secador y del compresor de aire, no instale el equipo donde el aire circundante contenga contaminantes sólidos o gaseosos, en particular azufre, amoníaco y cloro. Evite también la instalación en ambiente marino.
En las versiones con ventiladores axiales, se desaconseja canalizar el aire agotado.

3.5 Conexiónado eléctrico

Utilice un cable homologado con arreglo a las reglamentaciones locales (para la sección mínima del cable, vea el apartado 8.3).
Instale un interruptor magnetotérmico diferencial aguas arriba del equipo (RCCB - IDn = 0,3 A) con distancia 3 mm entre los contactos cuando el interruptor está abierto (consulte las disposiciones locales al respecto).
La corriente nominal "In" de dicho magnetotérmico debe ser igual a FLA y la curva de intervención de tipo D.

Seleccione la fuente de alimentación e inserte un puente como se muestra a continuación:

S7-S6 por 400/3/50

S8-S6 por 460/3/60

Dentro del cuadro eléctrico hay una etiqueta de instrucciones.

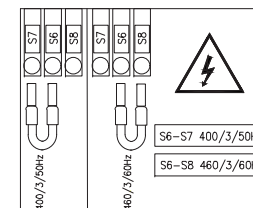

3.6 Conexión del drenaje de condensados

☞ Para conectar el equipo al sistema de drenaje, evite la conexión en circuito cerrado en común con otras líneas de descarga presurizadas. Compruebe que los condensados fluyan correctamente. Deseche los condensados con arreglo a las normas medioambientales vigentes.

4 Puesta en Marcha

4.1 Comprobaciones previas

Antes de poner en marcha el secador, asegúrese de que:

- a instalación haya sido realizada de acuerdo con lo expuesto en la sección 3;
- las válvulas de entrada del aire están cerradas y no hay flujo de aire en el secador;
- el suministro eléctrico es correcto;
- con la versión Wc, abra el circuito de agua de refrigeración durante unos minutos antes de encender el secador.



4.2 Arranque

1. encienda la alimentación girando el INTERRUPTOR

PRINCIPAL  "a "I ON". aparece esta información:

 **LA RESISTENCIA DEL CÁRTER DEBE ACTIVARSE 12 HORAS ANTES DE PONER EN MARCHA EL SECADOR.**

Después, toque para entrar al panel de control.

2. toque  para arrancar, el botón cambia de atenuado a verde, para indicar que ahora el secador está en funcionamiento .

3. Encienda el secador antes que el compresor de aire;
El incumplimiento de esta regla puede causar daños graves al compresor.

 Ventiladores (versión Ac): si están conectados con la secuencia de fase incorrecta, girarán en dirección opuesta con riesgo de dañarse (en este caso el aire saldrá del armario del secador por las rejillas del condensador en vez de por la rejilla del ventilador - consulte el párr. 8.6 y 8.7 para el flujo de aire correcto); invierta inmediatamente las dos fases.

4. Espere 5 minutos y después abra lentamente la válvula de entrada de aire;
5. abra lentamente la válvula de salida de aire: ahora el secador está secando.

Monitor de fase

Si aparece la alarma "Monitor de fase" en la pantalla durante el arranque del secador, el usuario deberá revisar el cableado de los terminales de entrada del interruptor de desconexión del secador.

4.3 Funcionamiento

- Deje el secador en marcha durante todo el periodo de funcionamiento del compresor de aire;
- El secador funciona en modo automático, por lo tanto, no es necesario realizar ajustes en el lugar de trabajo;
- En caso de producirse flujos de aire excesivos e inesperados, haga una derivación para no sobrecargar el secador.
- Evite las fluctuaciones de temperatura en el aire de entrada.

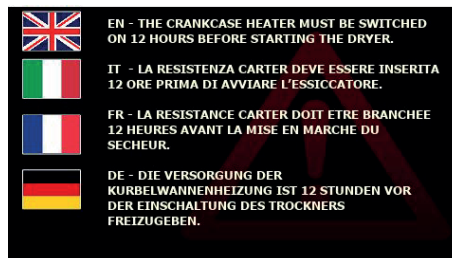

4.4 Parada

1. Detenga el secador 2 minutos después de que se detenga el compresor de aire o, en todo caso, después de la interrupción del flujo de aire;
2. asegúrese de que el aire comprimido no entra en el secador cuando este se encuentre desconectado o si ocurre una alarma.



3. Pulse  para apagar el secador. El botón cambia a atenuado 

4. Gire el INTERRUPTOR PRINCIPAL "  " a "O OFF" para desconectar la alimentación.

 Versión Wc: cierre el circuito de agua con el secador apagado.

5 Control

5.1 Panel de control

Botones táctiles	Función
	Secador OFF (atenuado)
	Secador ON (verde)

LOCAL = Local configuración
REMOTE = Remote configuración

Función	Botones táctiles	Función
<p>FS 48 %</p> <p>Velocidad de funcionamiento del ventilador (solo para la versión con condensador de aire)</p>		Access to information menu: machine status, pressures, temperatures, general settings, consumption, user password
<p>HGBV 14 %</p> <p>Velocidad de funcionamiento de la válvula de gas caliente</p>		Gris = sin alarma Rojo = advertencia Rojo intermitente = Alarma
<p>ECO 0%</p> <p>ahorro de energía % (ciclos)</p>		Secador apagado = luz gris Ciclo activo = verde intermitente Compresor activo = azul claro
		gris = Descarga de condensado OFF verde = Descarga de condensado ON

Función	Botones táctiles	Función
<p>Tendencia de punto de condensación</p>		Toque: para un drenaje manual
		<p>Función</p> <p>Strep led: azul = Compresor active verde = ahorro de energía rojo = Alarma</p>

5.2 Menú principal

Toque para acceder al menú de "Información":

Cuando se toca uno de los "botones táctiles", durante unos segundos se ilumina el contorno para confirmar que se realizó la selección.

Esto se aplica a cada "botón táctil" presente en el panel de control.

Toque para volver al panel de control.

5.2.1 Estado del aparato (I/O)

Toque para acceder al menú de "estado del aparato".

Esta es la lista de entradas:
Un LED al lado de la descripción indica lo siguiente sobre las protecciones / funciones / configuración:
activo = luz verde
inactivo = atenuado.

Toque para acceder a la siguiente página.

Esta es la lista de salidas:

Toque para volver al menú anterior.

5.2.2 Presión

Toque  para acceder al menú de "presión" y visualizar lo siguiente: presión de condensación, velocidad de funcionamiento del ventilador, presión de evaporación, velocidad de funcionamiento de la válvula de gas caliente. Toque em un parámetro específico para visualizar sua tendência de dados de desempenho ao longo do tempo.

Por ej., "Presión de condensación/evaporación"

Utilice  y  para desplazarse por el gráfico.

Toque  para volver al menú anterior.

Por ej., "Velocidad de funcionamiento de la válvula de gas caliente/ventilador"

Utilice  y  para desplazarse por el gráfico.

Toque  para volver al menú anterior.

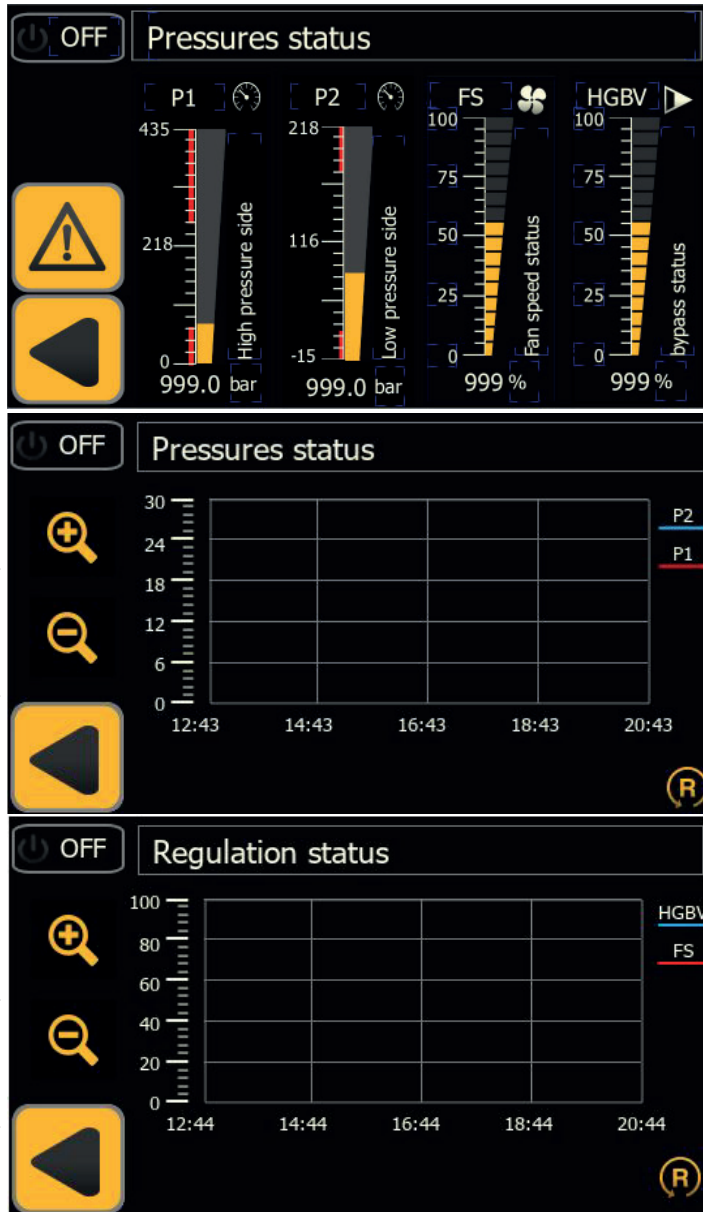

5.2.3 Temperatura

Toque  para visualizar las lecturas de temperatura de las sondas de temperatura del diagrama de circuito.



Toque  para acceder a la siguiente página.

B4 = Activa solo para la versión Multi-cooler.

Toque em um dos valores de temperatura de baixa pressão para ver uma tendência de dados de todas as sondas no circuito de baixa pressão.

Toque em um dos valores de temperatura de alta pressão para ver uma tendência de dados de todas as sondas no circuito de alta pressão.

Temperatura - baja presión circuito

Utilice  y  para desplazarse por el gráfico.

Toque  para volver al menú anterior.

Temperatura - alta presión circuito

Utilice  y  para desplazarse por el gráfico.

Toque  para volver al menú anterior.

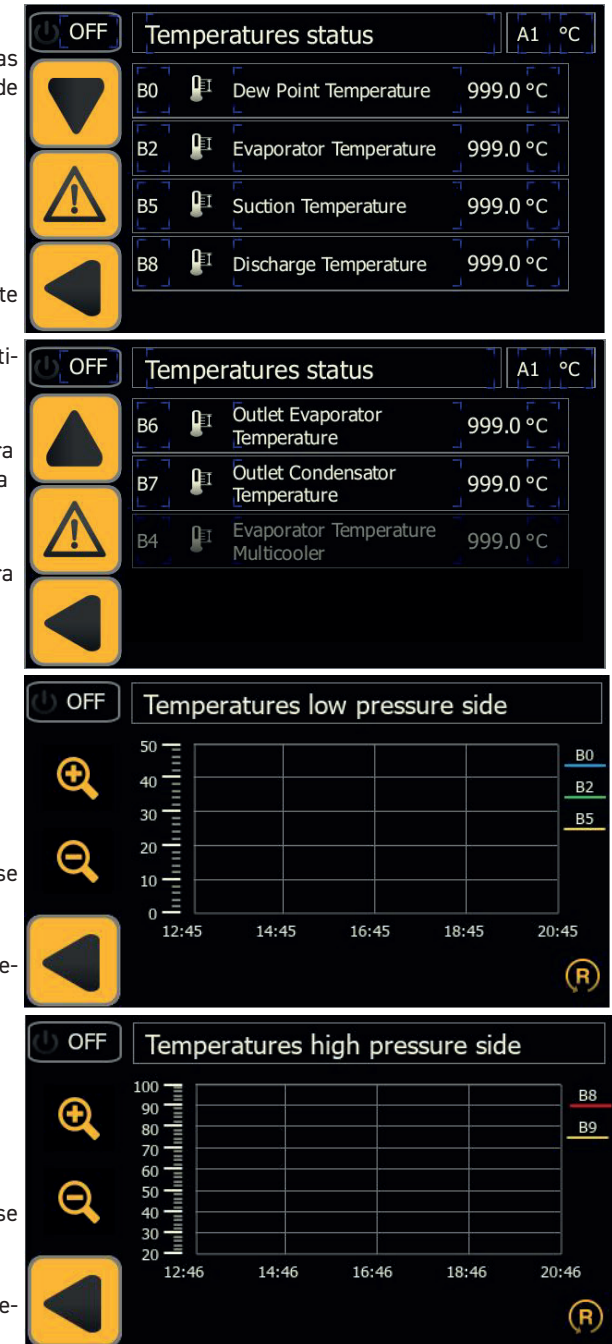

5.2.4 Download

Use um USB com led, que mostra a fase de download.
(8gB formatado como FAT32) insertar en el panel frontal.

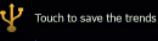
Toque  para iniciar la descarga.

El tiempo de descarga de datos depende de la cantidad de datos almacenados.

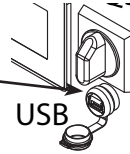

5.2.5 Fecha del número de serie

Toque  para acceder al menú de "Serial number".

Serial number	OFF
HMI version:	1.520.20
PLC version:	9.999
PSE serial number	999999999999
IP address	172.18.238.213

Toque  para volver al panel de control.

5.2.6 General

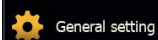
Toque  para acceder a un menú "general" con las siguientes secciones: idioma; fecha/hora; parámetro; mantenimiento; ciclos/funcionamiento continuo.

toque em qualquer menú para visualizar / ajustar. .

Toque  para volver al panel de control.

Languages Selection	OFF
Set Data Time	
Parameters	
Users access	

5.2.6.1 Idioma

Toque  para acceder al menú de idioma. Toque en el idioma que necesite. Volverá automáticamente al menú principal con el idioma que haya elegido.

Toque  para volver al menú anterior.

Toque en el idioma que necesite. Volverá automáticamente al menú principal con el idioma que haya elegido.

Toque  para volver al menú anterior.

English	Italian	German
Czech	Polish	Slovak

French	Spanish	Swedish
Russian	Dutch	Portuguese

5.2.6.2 Fecha/Tiempo

Toque  para acceder al menú de "fecha/tiempo".

Toque Fecha/Tiempo para proceder con el cambio.

Presione durante 2 segundos

 27/mag/2021 - 17:03:34 Sunday

para confirmar.

Toque  para volver al menú anterior.

Set Data Time	OFF				
Week	Sunday				
Sec	Seconds	0	Day	Day of month	0
Min	Minutes	0	Mon	Month	0
Hou	Hours	0	Yea	Year	2000
Keep touch to set Date and Time	27/mag/2021 - 17:03:34 Sunday				

5.2.6.3 User menu

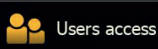
Toque  Users access para acceder al menú de "User".

Esto menú está reservado para el técnico de servicio de Parker.

User name:

Password:

Show password

5.2.6.4 Parámetro

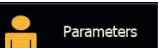
Toque  Parameters para acceder al menú de "parámetros" con las siguientes secciones: sondas, descarga de condensado, configuración, mantenimiento, ciclos.

Toque el "botón táctil" para acceder al menú.

Toque  para volver al menú anterior.

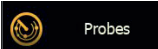

Sondas

Toque  Probes para ajustar las advertencias, los retrasos o el límite mínimo/máximo del punto de condensación.

Toque  para volver al menú anterior.

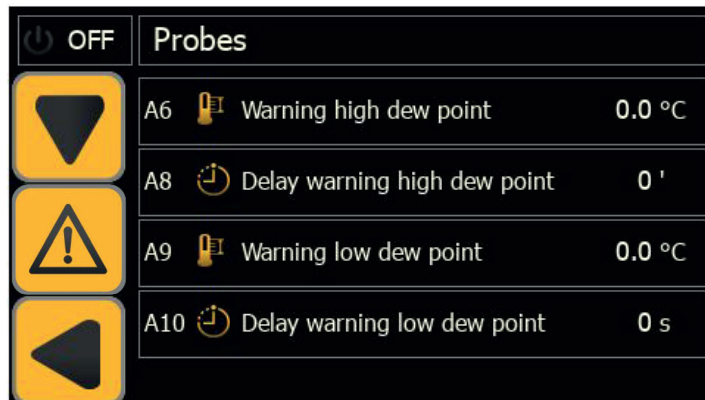

Descarga de condensado

Toque  Condensate drain para acceder al menú de "descarga de condensado".

Puede elegir lo siguiente:

1. Descarga temporizada (selección de los tiempos de cierre y apertura);
2. Descarga capacitiva;
3. Descarga continua (externa).

Toque  para volver al menú anterior.

Configuración

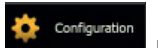
Toque  Configuration para acceder a la pantalla de configuración con el siguiente menú:

1. selección de la medida de temperatura °C / °F;
2. activación del control remoto;
3. activación solo de alarmas o de alarmas / advertencias;
4. restablecimiento a los parámetros predeterminados.

Utilice el "botón táctil" al lado de la descripción para seleccionar.

 Para administrar el modo REMOTE OFF, retire el puente entre los terminales: 87-92 y conecte el interruptor de arranque / parada remoto (a ser proporcionado por el cliente).

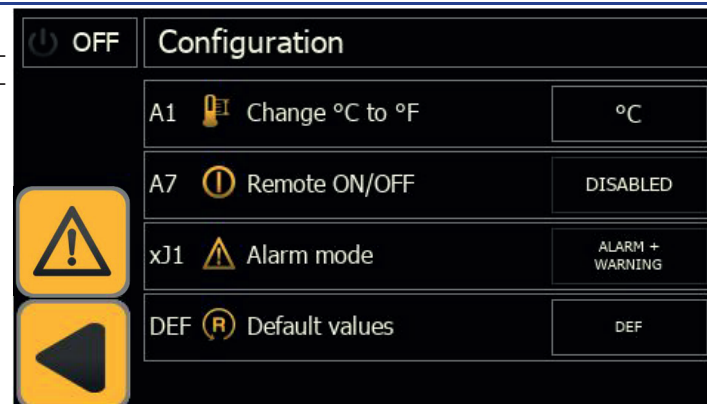

Mantenimiento

Toque  para ver las horas de funcionamiento del compresor/secador.

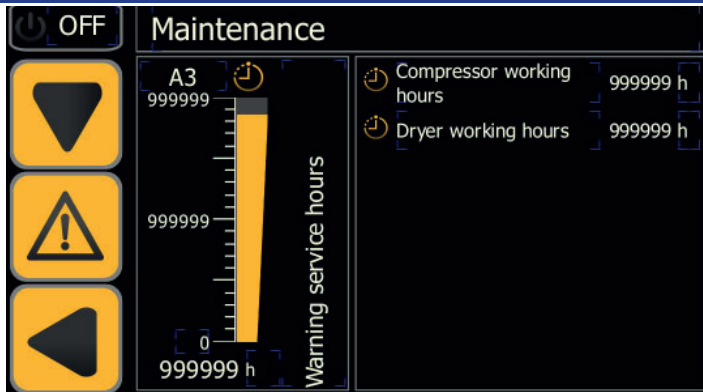

The Maintenance screen features a power button labeled 'OFF' and a 'Maintenance' title. On the left, there are three touch-sensitive buttons: a downward arrow, a warning triangle, and a leftward arrow. The main area displays 'A3' with a clock icon and a vertical bar graph labeled 'Warning service hours' with a scale from 0 to 999999 h. On the right, there are two rows of data: 'Compressor working hours' and 'Dryer working hours', both showing '999999 h'.

Toque  para volver al menú anterior.

Funcionamiento

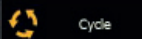
Toque  para elegir el tiempo de funcionamiento: continuo; por ciclos (ahorro de energía). Utilice el "botón táctil" al lado de la descripción para seleccionar.

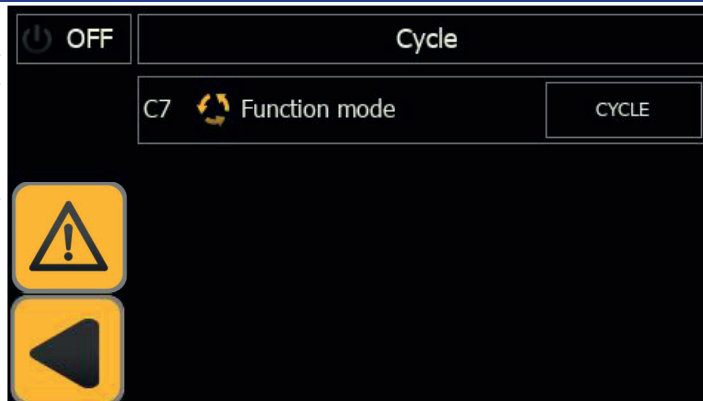

The Cycle screen has a power button labeled 'OFF' and a 'Cycle' title. It shows 'C7' with a cycle icon and 'Function mode' with a 'CYCLE' button. On the left, there are two touch-sensitive buttons: a warning triangle and a leftward arrow.

Toque  para volver al menú anterior.

Modbus

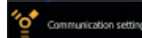
Toque  para configurar los parámetros de Modbus.

MODBUS RTU (RS485)

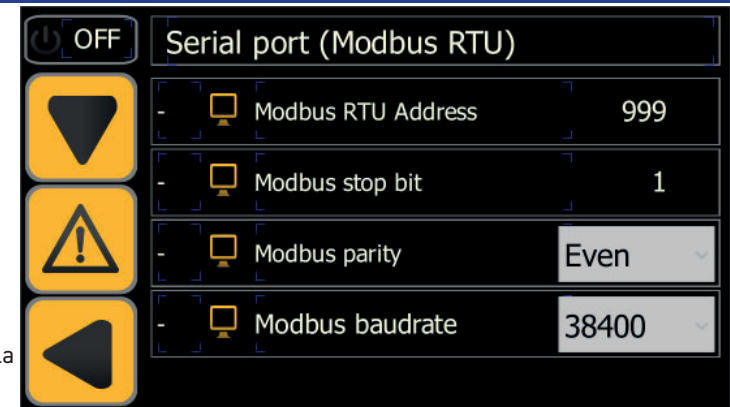

The Serial port (Modbus RTU) screen has a power button labeled 'OFF' and a title. On the left, there are three touch-sensitive buttons: a downward arrow, a warning triangle, and a leftward arrow. The main area lists four parameters: 'Modbus RTU Address' (999), 'Modbus stop bit' (1), 'Modbus parity' (Even), and 'Modbus baudrate' (38400).

Toque  para acceder a la siguiente página.

MODBUS TCP/IP

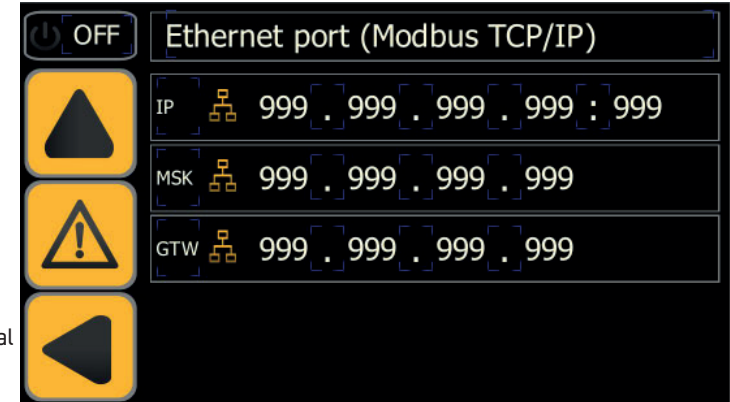

The Ethernet port (Modbus TCP/IP) screen has a power button labeled 'OFF' and a title. On the left, there are three touch-sensitive buttons: a warning triangle, a warning triangle, and a leftward arrow. The main area lists three parameters: 'IP' (999 . 999 . 999 . 999 : 999), 'MSK' (999 . 999 . 999 . 999), and 'GTW' (999 . 999 . 999 . 999).

Toque  para volver al menú anterior.

Detener/enciender el secador para confirmar.

Cloud

Toque  para ver "password" para cloud.

Esta opción está en marcha.



The Cloud Licence screen has a power button labeled 'OFF' and a title. It shows a cloud icon and the number '99999'. On the left, there are two touch-sensitive buttons: a warning triangle and a leftward arrow.

Toque  para volver al menú anterior.

5.3 Alarmas/advertencias

Toque  para acceder al menú de “alarmas/advertencias”:

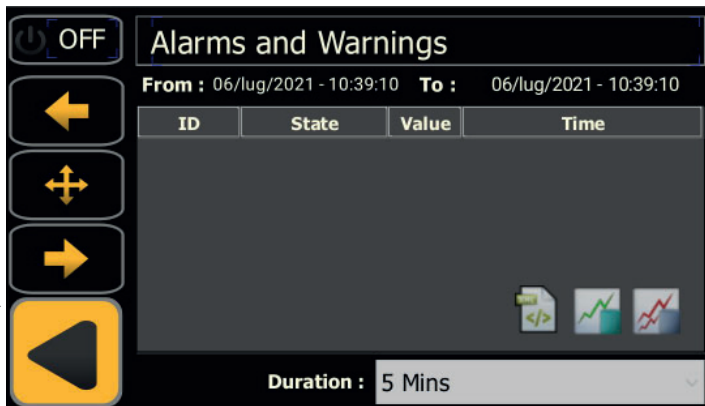

Toque “duration” para cambiar el tiempo de la investigación.

Cuando se han restablecido las condiciones de funcionamiento nominales, algunas advertencias y alarmas se reinician automáticamente; es necesario restablecer manualmente las demás alarmas/advertencias.

Toque  para reiniciar la alarma.

Toque  para ver el historial de alarmas con:

código de alarma, fecha, número de alarmas, posición de la secuencia, y hora de activación de las alarmas..

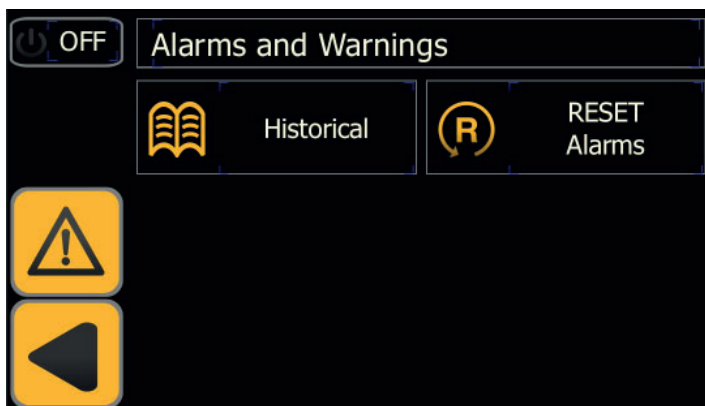

Toque  para volver al menú anterior.

5.3.1 Lista de alarmas y avisos

a = alarma; w = aviso

Code	Alarmas/Avisos	Causa
aLD	alarma Bajo punto de rocío	temperatura B0<A9 por más de A10 segundo .
aLT	alarma baja temperatura de evaporación	temperatura B2<A12 por más de A13 segundo
aHT2	alarma alta temperatura de descarga	temperatura B8>A11
aHP	alarma alta presión	presostato de alta presión activado
aLP	alarma baja presión	presostato de baja presión activado
aLTA	alarma baja temperatura multicooter	temperatura B4<A12 por más de A13 segundo
aPI*	compressor thermal Protection alarm	thermal Protection compressor activado
aPH	alarma monitor de fase	monitor de fase activado (solo para 460-750)
aCM1	alarma comunicación de la expansión 1	la expansión 1 no comunica
aCM2	alarma comunicación de la expansión 2	la expansión 2 no comunica
wB0	aviso sonda B0	sonda rota o no conectada
wB2	aviso sonda B2	sonda rota o no conectada
wB4	aviso sonda B4	sonda rota o no conectada
wB5	aviso sonda B5	sonda rota o no conectada
wB6	aviso sonda B6	sonda rota o no conectada
wB8	aviso sonda B8	sonda rota o no conectada
aFP1	aviso alta presión transmisor P1	transmisor rota o no conectada
wHD	aviso alto de punto de rocío	temperatura B0>A6 por más de A8 minutos
wHT1	aviso alta temperatura de descarga	temperatura B8>A14 por más de A15 minutos
wHP1	aviso alta presión	presión P1>A16 por más de 2 segundo
wHB5	aviso alta temperature de entrada	tempertura B5>A18 por más de 1 minuto
wLP2	aviso baja presión	presión P2<A21 por más de 150 segundos
wSR	Aviso Mantenimiento programado	tiempo de servicio transcurrido
wDR1	aviso drenaje de condensados 1	drenaje de condensados de secador 1 no descarga
wDR2	aviso drenaje de condensados 2	drenaje de condensados de secador 2 no descarga
wDR3	aviso drenaje de condensados 3	drenaje de condensados de secador 3 no descarga
aFP2	aviso baja presión transmisor P2	transmisor rota o no conectada

* para los modelos 900-1800 la alarma también puede tener el significado de fases invertidas.



5.4 Menú rápido

Acceda al menú mediante pasos rápidos:

Visualizar la temperatura

Toque  → Toque  Toque la temperatura para ver los gráficos.

Visualizar la presión

Toque  → Toque  Toque la presión para ver los gráficos.

Download

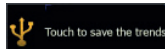
Toque  → Toque  para la descarga.



Serial number

Toque  → Toque 

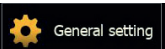
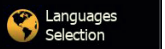
Cambiar el idioma

Toque  → Toque  → Toque  para elegir el idioma.

Fecha/Tiempo

Toque  → Toque  → Toque  para actualizar el reloj.

Cambiar las unidades de medida de °C a °F, Remote, DEF

Toque  → Toque  → Toque  → Toque  :

Toque el parámetro “°C” o “°F” para realizar el cambio.



Habilita/deshabilita el parámetro “Remote ON/OFF” .

Toque “DEF” para restaurar el parámetro.

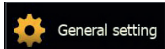
Cambiar a funcionamiento “por ciclos”

Toque  → Toque  → Toque  → Toque  para cambiar el funcionamiento.

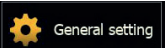
Descarga

Toque  → Toque  → Toque  → Toque  para elegir la descarga.

Modbus

Toque  → Toque  → Toque  → Toque 

Ajustar los parámetros

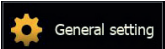
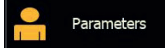
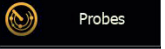
Toque  → Toque  → Toque  → Toque  para cambiar el parámetro.

Alarma / advertencia

Toque  → Toque  para encontrar la alarma histórica y restablecer la alarma.

Toque  para ver los datos históricos.

Toque  para restablecer la alarma.

6 Mantenimiento

• El aparato ha sido diseñado y fabricado para garantizar un funcionamiento continuo; No obstante, la vida útil de sus componentes depende del mantenimiento que se realice.

•  Cuando pida ayuda o piezas sueltas, identifique el aparato (modelo y número de serie) leyendo la placa de datos ubicada en la máquina.

• Los circuitos que contengan 5t < xx < 50t de CO2 son comprobados para localizar fugas al menos una vez al año.

Los circuitos que contengan 50t < xx < 500t de CO2 son comprobados para localizar fugas al menos una vez cada seis meses. ((UE) N° 517/2014 art. 4.3.a, 4.3.b).

• Para los aparatos que contengan 5t de CO2 o más, el operario deberá llevar un registro en el que se indique la cantidad y el tipo de refrigerante usado, y las cantidades añadidas y recuperadas en las operaciones de mantenimiento, reparaciones y eliminación final ((UE) N° 517/2014 art. 6).

6.1 Advertencias generales

 Antes de realizar cualquier operación de mantenimiento, compruebe que:

- el circuito neumático no esté a presión,
- el secador esté desconectado de la red eléctrica.

 El uso de repuestos no originales exime al fabricante de toda responsabilidad por el mal funcionamiento del equipo.

 En caso de pérdida de refrigerante, llame a un técnico experto y autorizado.

 La válvula Schrader debe utilizarse sólo en caso de funcionamiento anómalo del equipo; de lo contrario, los daños causados por una carga incorrecta de refrigerante no serán reconocidos en garantía.

6.2 Refrigerante

Operación de carga: los daños causados por una carga del refrigerante incorrecta realizada por personal no autorizado no serán reconocidos en garantía. 

 El aparato contiene gases fluorados de efecto invernadero.

El fluido refrigerante R513A, a temperatura y presión normales, es un gas incoloro perteneciente al SAFETY GROUP A1 - EN378 (fluido del grupo 2 según la directiva PED 2014/68/UE); GWP (Global Warming Potential) = 573.

 En caso de fuga de refrigerante, airee el local.

6.3 Programa de mantenimiento preventivo

Para garantizar la máxima eficiencia y fiabilidad del secador a lo largo del tiempo, lleve a cabo:

Acciones de mantenimiento	Intervalo de tiempo (condiciones de funcionamiento estándar)				
	Diarias	Semanales	4 Meses	12 Meses	36 Meses
Comprobar que el indicador POWER ON está encendido.					
Comprobar todos los indicadores del panel de control.					
Limpiar el filtro de la válvula presostática de agua, si no está sucio aumentar el intervalo de inspección (ver instrucciones) (PSE750-1800)					
Comprobar el purgador.					
Limpiar el condensador, rejilla y conexiones.					
Comprobar que la posición/ operación de la resistencia del cárter sea correcta					
Comprobar el consumo eléctrico.					
Comprobar las pérdidas de refrigerante.					
Despresurizar la instalación. Hacer mantenimiento integral del purgador.					
Despresurizar la instalación. Sustituir todos los elementos filtrantes de los filtros instalados.					
Comprobar las sondas de temperatura. Sustituir si fuera necesario.				 	
Conjunto de mantenimiento del secador.					



Están disponibles (apartado 8.4):

- a) kits de mantenimiento preventivo de los 3 años;
- b) kits de servicio
 - kits compresor
 - kits ventilador
 - kits de válvula gas caliente
 - Kits de condensador de agua
- c) piezas de repuesto individuales.

6.4 Desguace

El fluido refrigerante y el aceite lubricante contenidos en el circuito deben recogerse de conformidad con las normas locales.

El líquido refrigerante se debe recuperar antes de la destrucción definitiva del equipo ((UE) N° 517/2014 art.8).

	Reciclaje Desecho 
estructura	acero/resinas epoxi-poliéster
intercambiador	aluminio
tuberías/colectores	cobre/aluminio/acero al carbono
drenaje condensados	polyamide
aislamiento intercambiador	EPS (poliestireno sinterizado)
aislamiento tuberías	caucho sintético
compresor	acero/cobre/aluminio/aceite
condensador	cobre/aluminio
refrigerante	R513A
válvulas	latón
cables eléctricos	cobre/PVC

Los equipos que contengan componentes eléctricos deben eliminarse por separado junto con los residuos eléctricos y electrónicos de acuerdo con la legislación local y vigente.



7 Solución de problemas

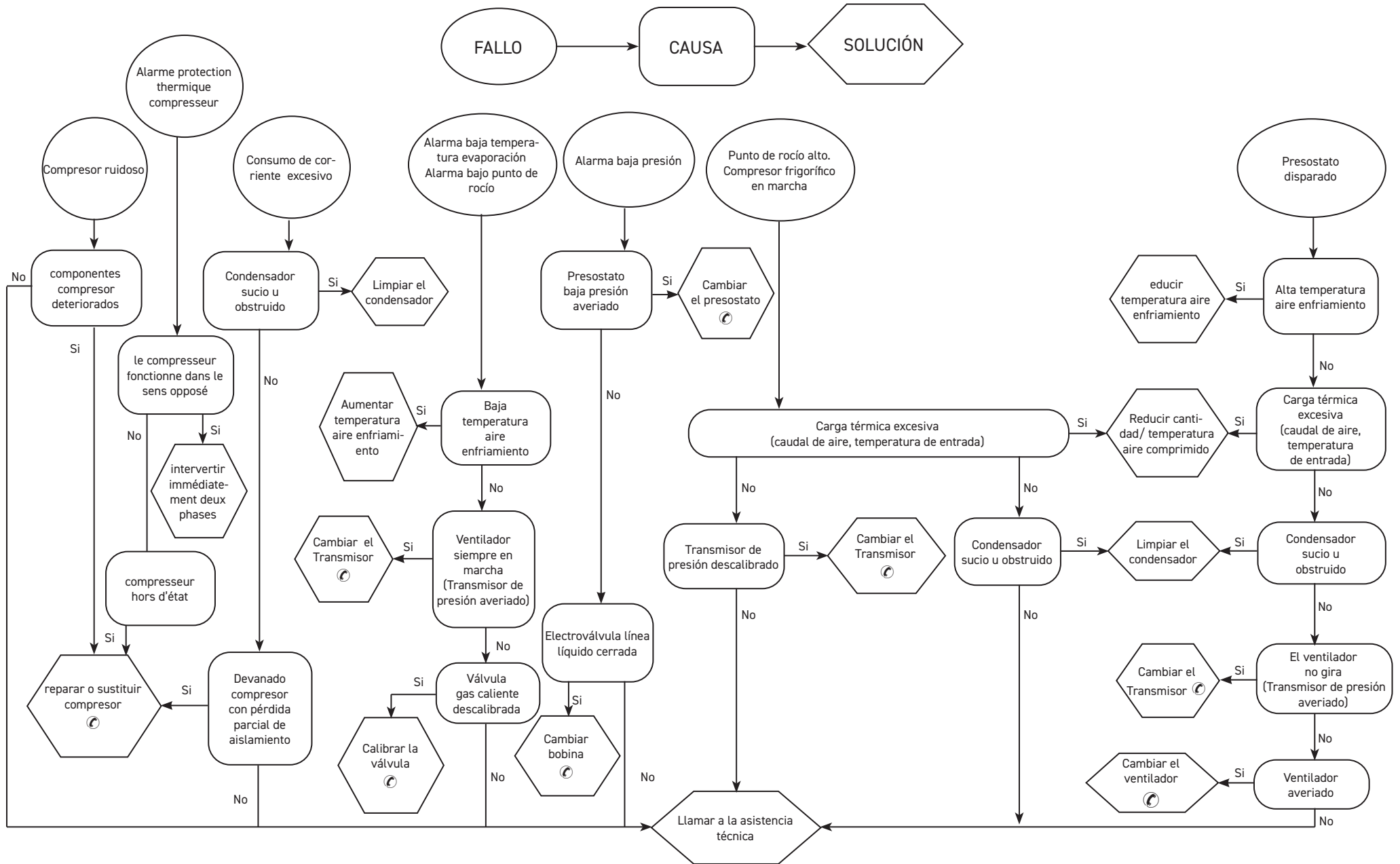

Sommaire

1 Sécurité	1
1.1 Importance de la notice.....	1
1.2 Signaux d'avertissement.....	1
1.3 Consignes de sécurités.....	1
1.4 Risques résiduels.....	2
2 Introduction	2
2.1 Transport.....	2
2.2 Manutention.....	2
2.3 Inspection ou visite.....	2
2.4 Stockage.....	2
3 Installation	3
3.1 Procédure.....	3
3.2 Espace de travail.....	3
3.3 Version condenseur.....	3
3.4 Recommandations.....	3
3.5 Raccordement électrique.....	3
3.6 Raccordement purgeur des condensats.....	3
4 Mise en service	4
4.1 Contrôles préliminaires.....	4
4.2 Démarrage.....	4
4.3 Fonctionnement.....	4
4.4 Arrêt.....	4
5 Commande	5
5.1 Panneau de commande.....	5
5.2 Menu principal.....	5
5.2.1 État de la machine (E/S).....	5
5.2.2 Pression.....	6
5.2.3 Température.....	6
5.2.4 Télécharger.....	7
5.2.5 Date du numéro de série.....	7
5.2.6 Général.....	7
5.2.6.1 Langue.....	7
5.2.6.2 Date/ Temps.....	7
5.2.6.3 Menu User.....	8
5.2.6.4 Paramètre.....	8
5.3 Alarmes/ Avertissements.....	10
5.3.1 Liste des alarmes/avertissement.....	10
5.4 Menu Rapide.....	11
6 Entretien	12
6.1 Recommandations générales.....	12
6.2 Réfrigérant.....	12
6.3 Programme d'entretien préventif.....	12
6.4 Mise au rebut.....	13
7 Dépannage	14
8 Appendice	

1 Sécurité

1.1 Importance de la notice

- La notice doit être conservée pendant toute la durée de vie de la machine.
- Lire la notice avant toute opération ou intervention.
- La notice est sujette à modifications : pour une information actualisée, consulter la version à bord de la machine.

1.2 Signaux d'avertissement



Instructions pour éviter de faire courir des risques aux personnes



Instructions à suivre pour éviter de faire subir des dégâts à l'appareil.





La présence d'un professionnel qualifié et agréé est exigée





Sont présents des symboles dont la signification est donnée au paragraphe 9.1

1.3 Consignes de sécurités

 Chaque unité est munie d'un sectionneur électrique pour permettre toute intervention en conditions de sécurité. Toujours actionner ce dispositif pour éliminer les risques pendant les opérations d'entretien.

 La notice s'adresse à l'utilisateur final uniquement pour les opérations pouvant être effectuées panneaux fermés ; par contre, les opérations qui nécessitent l'ouverture avec des outils doivent être confiées à un professionnel expert et qualifié.

 Ne pas dépasser les limites définies par le projet, qui sont indiquées sur la plaque des caractéristiques.

 Il incombe à l'utilisateur d'éviter des charges différentes de la pression statique interne. En cas de risque d'activité sismique, l'unité doit être convenablement protégée.

 Les dispositifs de sécurité sur le circuit d'air sont à la charge de l'utilisateur.

 Le dimensionnement des dispositifs de sécurité du circuit de l'air comprimé doit être réalisé en tenant compte des caractéristiques techniques de l'installation et de la réglementation locale en vigueur. N'utiliser l'unité que pour un usage professionnel et pour la destination prévue par le constructeur. Il incombe à l'utilisateur d'analyser tous les aspects de l'application pour laquelle l'unité est installée, de suivre toutes les consignes industrielles de sécurité applicables et toutes les prescriptions inhérentes au

produit contenues dans le manuel d'utilisation et dans toute autre documentation réalisée et fournie avec l'unité. La modification ou l'adaptation ou le remplacement d'un composant quelconque par une personne non autorisée et/ou l'usage impropre de l'unité dégagent le constructeur de toute responsabilité et comportent l'annulation de la garantie.

Le constructeur ne saurait être tenu pour responsable pour tous les dommages matériels aux choses ou à l'unité et pour tous les dommages physiques aux personnes dérivant d'une négligence des opérateurs, du non-respect de toutes les instructions de la présente notice, de l'inapplication des normes en vigueur concernant la sécurité de l'installation.

La responsabilité du constructeur est dérogée pour tous les dommages ou dégâts éventuels pouvant résulter de manipulations malveillantes et/ou de modifications de l'emballage.

L'utilisateur doit s'assurer que les conditions fournies pour la sélection de l'unité ou de ses composants et/ou options sont parfaitement conformes pour une utilisation correcte de cette même unité ou de ses composants.

 **ATTENTION: Le fabricant se réserve le droit de modifier sans aucun préavis les informations contenues dans ce manuel. Afin de disposer d'informations complètes et actualisées, il est recommandé à l'utilisateur de consulter le fabricant.**

1.4 Risques résiduels

L'installation, la mise en marche, l'arrêt et l'entretien de la machine doivent être effectués conformément aux dispositions prévues par la documentation technique du produit et, quoiqu'il en soit, de manière à ne créer aucune situation de risque.

Les risques n'ayant pu être éliminés en phase de conception sont indiqués dans le tableau suivant.

partie concernée	risque résiduel	modalité	précautions
batterie d'échange thermique	petites coupures	contact	éviter tout contact, porter des gants de protection
grille ventilateur et ventilateur	lésions	introduction d'objets pointus à travers la grille lors du fonctionnement du ventilateur	n'introduire aucune sorte d'objets dans la grille des ventilateurs et ne poser aucun objet sur les grilles
partie interne de l'unité : compresseur et tuyau de refoulement	brûlures	contact	éviter tout contact, porter des gants de protection
partie interne de l'unité : parties métalliques et câbles électriques	intoxications, brûlures graves	incendie dû à un court-circuit ou une surchauffe de la ligne d'alimentation en amont du tableau électrique de l'unité	section des câbles et système de protection de la ligne d'alimentation électrique conformes aux normes en vigueur
partie externe de l'unité : zone environnante de l'unité	intoxications, brûlures graves	incendie dû à un court-circuit ou une surchauffe de la ligne d'alimentation en amont du tableau électrique de l'unité	section des câbles et système de protection de la ligne d'alimentation électrique conformes aux normes en vigueur

2 Introduction

Ce manuel fait référence aux sècheurs frigorifiques conçus pour éliminer la vapeur d'eau de l'air comprimé.

2.1 Transport

L'unité emballée doit rester :

- en position verticale ;
- à l'abri des intempéries ;
- à l'abri des chocs.

2.2 Manutention

Utiliser un chariot élévateur d'une capacité suffisante à soulever le poids de la machine. Éviter tous chocs pendant la manutention.

2.3 Inspection ou visite

- En usine, toutes les unités sont assemblées, câblées, chargées avec du réfrigérant et de l'huile et testées dans les conditions de travail normales ;
- après réception de la machine, l'examiner soigneusement pour vérifier son état : recourir contre le transporteur pour les dommages éventuellement survenus au cours du transport ;
- débarrasser l'unité le plus près possible de son lieu d'implantation.

2.4 Stockage

En cas d'empilage de plusieurs unités, suivre les instructions inscrites sur l'emballage. Conserver l'unité dans son emballage en un lieu propre et à l'abri de l'humidité et des intempéries.

3 Installation

☞ Installez à l'intérieur dans un endroit propre et sec qui est protégé des éléments, de la lumière directe du soleil et / ou d'autres conditions difficiles.

⚠ Le produit installé doit être convenablement protégé contre les risques d'incendie (réf. EN378-3).

3.1 Procédure

⚠ Pour les modèles s'assurer de visser les prisonniers ou goujons dans les brides jusqu'à fond de course avant de raccorder les contre-brides (voir paragraphe 8.6).

☞ Respecter les indications des paragraphes 8.2 et 8.3.

Tous les sècheurs doivent être équipés d'une préfiltration adéquate située à immédiate proximité de l'entrée du sécheur. Le revendeur se dégage de toute responsabilité en cas de dommage direct ou indirect causé par l'absence de ce préfiltre.

☞ L'élément préfiltrant (filtration des particules de 3 microns minimum) doit être remplacé une fois par an ou plus, selon les recommandations du fabricant.

☞ Connecter correctement le sécheur aux prises d'entrée et de sortie de l'air comprimé.

3.2 Espace de travail

☞ Prévoir un espace de dégagement de 1.5 m autour de l'unité.

Laisser 2 m d'espace au-dessus du sécheur pour les modèles à évacuation verticale de l'air de refroidissement.

3.3 Version condenseur

Version à air (Ac)

Ne pas créer des situations de recyclage de l'air de refroidissement.

Ne pas obstruer les grilles de ventilation.

Version à eau (Wc)

Si la fourniture ne le prévoit pas, monter une crépine sur l'entrée de l'eau de condensation.

☞ Caractéristiques de l'eau de condensation en entrée :

Température	≥50°F (10°C)	CL ⁻	<50 ppm
ΔT IN/OUT	5-15°C	CaCO ₃	70-150 ppm
Max % glycole	50	O ₂	<0.1 ppm
Pression	43.5-145 PSig (3-10 barg)	Fe	<0.2 ppm
PH	7.5-9	NO ₃	<2 ppm
Conductivité électrique	10-500 μS/cm	HCO ₃ ⁻	70-300 ppm
Indice de saturation de Langelier	0-1	H ₂ S	<0.05 ppm
SO ₄ ²⁻	<50 ppm	CO ₂	<5 ppm
NH ₃	<1 ppm	Al	<0.2 ppm

Pour des eaux de refroidissement spéciales (déionisée, déminéralisée, distillée) les matériaux standard prévus pour le condenseur pourraient ne pas être appropriés. Dans ce cas, veuillez contacter le constructeur.

3.4 Recommandations

Pour ne pas endommager les composants internes du sécheur et du compresseur d'air, éviter des installations où l'air des zones environnantes contient des contaminants : attention donc au soufre, à l'ammoniac, au chlore et aux installations en milieu marin.

Pour les versions avec ventilateurs axiaux, il est déconseillé de canaliser l'air épuisé.

3.5 Raccordement électrique

Utiliser un câble homologué aux sens des normes françaises en matière d'électricité et de la réglementation locale (pour la section minimale du câble, voir paragraphe 8.3).

Installer l'interrupteur magnéto-thermique différentiel en amont de l'installation (RCCB-IDn=0.3A) avec une distance d'ouverture des contacts 3mm (voir réglementation locale en vigueur en la matière et s'y conformer). Le courant nominal «In» de ce disjoncteur magnéto-thermique doit être égal à FLA et la courbe de déclenchement de type D.

Sélectionnez l'alimentation et insérez un pont comme indiqué ci-dessous

S7-S6 pour 400/3/50

S8-S6 pour 460/3/60

À l'intérieur du panneau électrique, il y a une étiquette d'instructions.

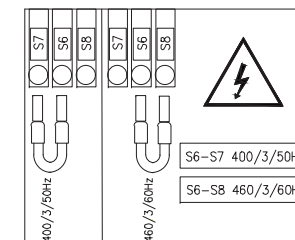

3.6 Raccordement purgeur des condensats

☞ Réaliser le raccordement au système de décharge en évitant le raccordement en circuit fermé en commun avec les autres circuits de décharge pressurisés. Contrôler que les systèmes de décharge évacuent régulièrement les condensats. Évacuer tous les condensats conformément à la législation antipollution en vigueur.

4 Mise en service

4.1 Contrôles préliminaires

Avant la mise en service du dessiccateur, vérifier que :

- l'installation a été réalisée conformément aux instructions fournies à la Section 3 ;
- la soupape d'admission d'air est ouverte et aucun écoulement d'air n'est présent dans le dessiccateur ;
- l'alimentation fournie est correcte ;
- en version Wc, ouvrir le circuit d'eau de refroidissement quelques minutes avant de démarrer le dessiccateur.

4.2 Démarrage

1. Mettre sous tension en tournant l'interrupteur

général"  " sur "I ON": apparaissent ces informations :

 **LA RESISTANCE CARTER DOIT ETRE BRANCHEE 12 HEURES AVANT LA MISE EN MARCHÉ DU SE-
CHEUR.**

After, appuyer pour revenir le panneau de commande.

2. appuyer sur  pour démarrer. Le bouton change de couleur, de gris il devient vert, pour in-

diquer que le dessiccateur est maintenant en marche .

3. Démarrer le dessiccateur avant le compresseur d'air.

Le non-respect de cette instruction peut endommager gravement le compresseur.

 Ventilateurs (version Ac) : s'ils sont raccordés dans l'ordre de phases incorrect, ils tourneront dans la direction opposée, avec le risque qu'ils subissent des dégâts (dans ce cas, l'air sort de l'armoire du dessiccateur par les grilles du condenseur plutôt que par les grilles des ventilateurs - pour le débit d'air correct, voir les par. 8.6 et 8.7) ; inverser immédiatement deux phases.

4. Attendre 5 minutes, puis ouvrir lentement la soupape d'admission d'air.
5. Ouvrir lentement la soupape d'échappement d'air : le dessiccateur fonctionne maintenant en mode séchage.

Moniteur des phases

Si l'alarme « Moniteur des phases » s'affiche pendant le démarrage du dessiccateur, l'utilisateur doit vérifier le câblage des bornes d'entrée du sectionneur du dessiccateur.

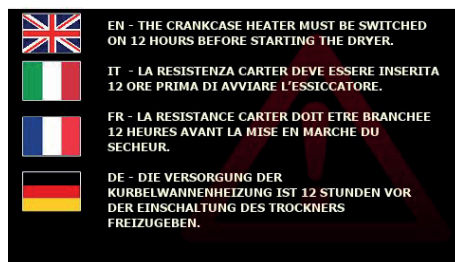



4.3 Fonctionnement

- Laisser le dessiccateur en marche tout le temps que le compresseur d'air fonctionne.
- Le dessiccateur travaillant en automatique, les réglages de champ ne sont pas nécessaires.
- En cas de débits d'air excessifs imprévus, les by-passer pour éviter toute surcharge du dessiccateur.
- Éviter les variations de température d'entrée.

4.4 Arrêt

1. Arrêter le dessiccateur 2 minutes après l'arrêt du compresseur d'air, ou en tout cas lorsque le débit d'air est interrompu.
2. Vérifier que l'air comprimé ne pénètre pas dans le dessiccateur quand le dessiccateur est débranché ou si une alarme s'est déclenchée.

3. Appuyer sur  pour mettre le dessiccateur hors tension. Le bouton change de couleur et devient gris. 



4. Tourner l'interrupteur général "  " sur « 0 OFF » pour mettre hors tension.

 En version Wc, fermer le circuit d'eau avec le dessiccateur arrêté.



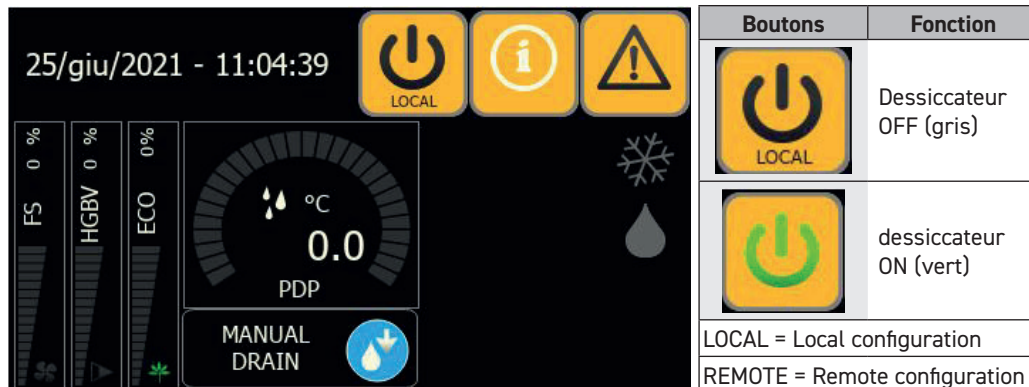

5 Commande

5.1 Panneau de commande

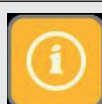

Boutons	Fonction
	Dessiccateur OFF (gris)
	dessiccateur ON (vert)

LOCAL = Local configuration
REMOTE = Remote configuration

Fonction	Boutons	Fonction
<p>FS 48 %</p> <p>Vitesse de fonctionnement du ventilateur (uniquement pour la version à condenseur à air)</p>		Accès au menu Information : état de la machine, pressions, températures, paramètres généraux, consommation, mot de passe utilisateur
<p>HGBV 14 %</p> <p>Vitesse de fonctionnement de la soupape des gaz chauds</p>		Gris = aucune alarme Rouge = avertissement Rouge clignote = alarme
<p>ECO 0%</p> <p>économie d'énergie.% (Cycle)</p>		Dryer OFF = gris clair Cycling active = vert clignotant Compressor active = bleu clair
		gris = Purgeur de l'eau de condensation OFF vert = Purgeur de l'eau de condensation ON

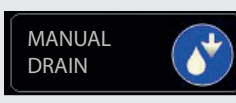
Fonction	Boutons	Fonction
<p>8.0</p> <p>PDP</p> <p>Appuyer: pour une purge manuelle</p>		Tendance du point de rosée
		<p>Fonction</p> <p>Strep led: bleu = Compressor active vert = économie d'énergie rouge = alarme</p>

5.2 Menu principal

Appuyer sur  pour ouvrir le menu Information.

Quand un des boutons est enfoncé pendant quelques secondes, le contour s'allume pour confirmer que la sélection a été effectuée.

Ceci vaut pour tous les boutons du panneau de commande.

Appuyer sur  pour revenir les panneau de commandel.

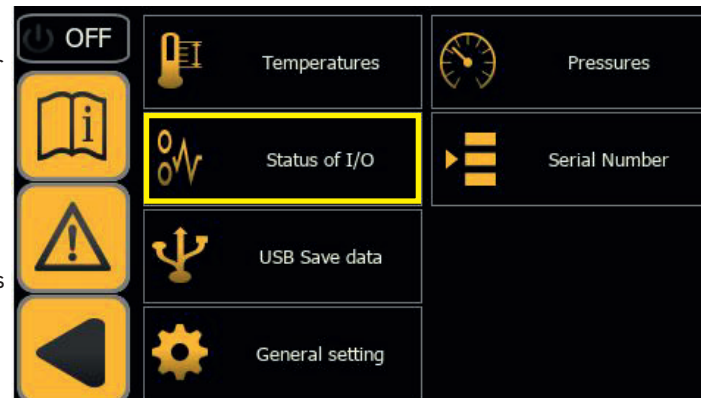

5.2.1 État de la machine (E/S)

Appuyer sur  pour ouvrir le menu État de la machine.

Liste des entrées :
Une LED à côté de la description indique si les protections / fonctions / configurations sont :
actives = vert clair
pas actives = gris clair
e.g .

Appuyer sur  pour passer à la page suivante.
Liste des sorties :

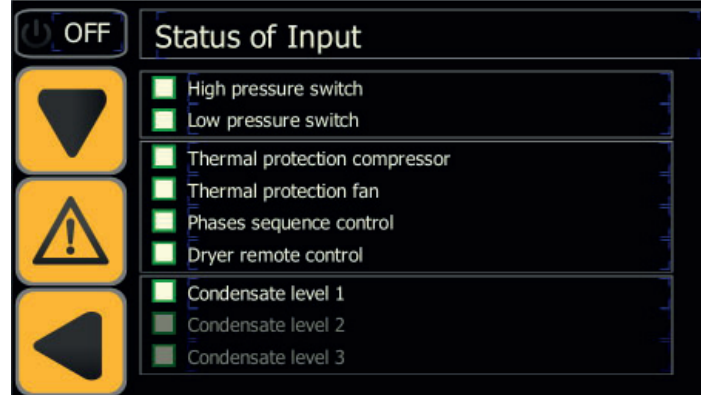

Appuyer sur  pour revenir au menu précédent.

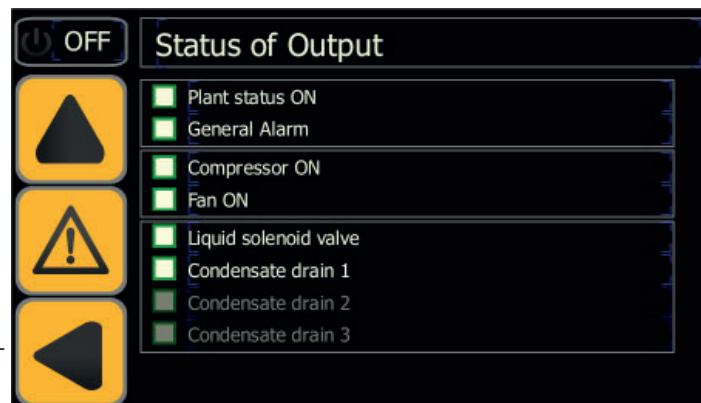

5.2.2 Pression

Appuyer sur  pour ouvrir le menu Pression pour visualiser : la pression de condensation, la vitesse de fonctionnement du ventilateur, la pression d'évaporation, la vitesse de fonctionnement de la soupape des gaz chauds.

Appuyez sur un paramètre spécifique pour afficher la tendance des données de ses performances au fil du temps.

p.ex. Pression de condensation/d'évaporation

Utiliser  et  pour faire défiler le graphique.

Appuyer sur  pour revenir au menu précédent.

p.ex. Vitesse de fonctionnement de la soupape des gaz chauds/du ventilateur

Utiliser  et  pour faire défiler le graphique.

Appuyer sur  pour revenir au menu précédent.

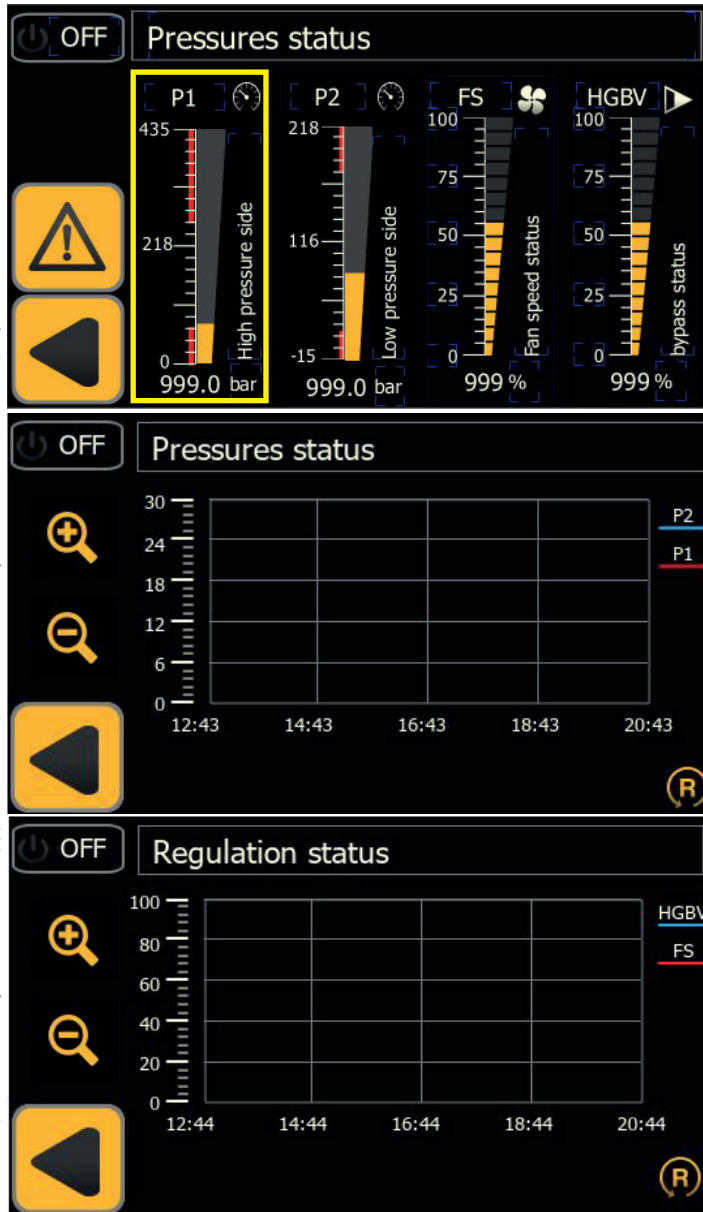

5.2.3 Température

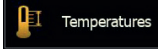
Appuyer sur  pour afficher les températures relevées par les capteurs de température du schéma du circuit.



Appuyer sur  pour passer à la page suivante.

B4 = actif uniquement pour la version multicooler.

Appuyez sur l'une des valeurs de température basse pression pour voir une tendance des données de toutes les sondes du circuit basse pression.



Appuyez sur l'une des valeurs de température haute pression pour voir une tendance des données de toutes les sondes du circuit haute pression.

Température - Basse pression circuit

Utiliser  et  pour faire défiler le graphique.

Appuyer sur  pour revenir au menu précédent.

Température - Haute pression circuit

Utiliser  et  pour faire défiler le graphique.

Appuyer sur  pour revenir au menu précédent.

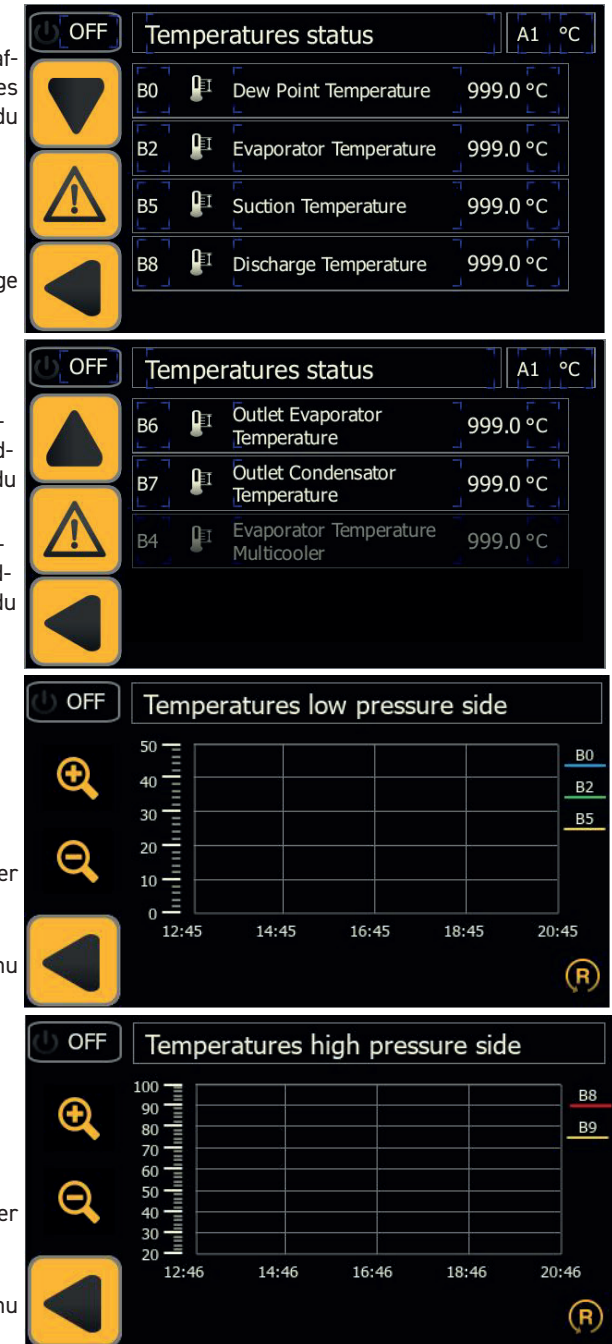

5.2.4 Télécharger

Utilisez une clé USB avec led, qui vous montre la phase de téléchargement. (8gB formaté en FAT32) insérer dans le panneau avant.

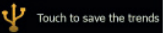
Appuyer sur  pour lancer le téléchargement. Le temps de téléchargement des données dépend de la quantité de données stockées.

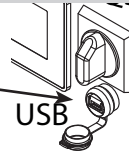

5.2.5 Date du numéro de série

Appuyer sur  pour ouvrir le menu «serial number».

Appuyer sur  pour revenir les panneau de commande.

5.2.6 Général

Appuyer sur  pour ouvrir le menu Général qui propose les sections suivantes : langue ; date/heure ; paramètre ; maintenance ; cycle/fonctionnement continu. Appuyer un menu pour afficher / régler.

Appuyer sur  pour revenir les panneau de commande.

5.2.6.1 Langue

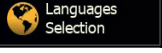
Appuyer sur  pour ouvrir le menu Langue. Appuyer sur la langue souhaitée. Le système revient automatiquement au menu principal dans la langue choisie.

Appuyer sur  pour revenir au menu précédent.

Appuyer sur la langue souhaitée. Le système revient automatiquement au menu principal dans la langue choisie.

Appuyer sur  pour revenir au menu précédent.

5.2.6.2 Date/Temps

Appuyer sur  pour ouvrir le menu Date/temps.

Appuyer sur Date/Temps pour effectuer la modification.

Appuyez pendant 2 secondes

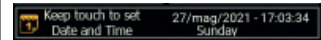

pour confirmer.

Appuyer sur  pour revenir au menu précédent.

5.2.6.3 Menu User

Appuyer sur  Users access pour ouvrir le menu "User". Ce menu est réservé aux techniciens de service Parker.

User name:

Password:

Show password

5.2.6.4 Paramètre

Appuyer sur  Parameters pour ouvrir le menu Paramètre qui propose les sections suivantes : capteurs, purgeur, configuration de l'eau de condensation, maintenance, cycle. Appuyer sur le bouton pour ouvrir le menu.

Appuyer sur  pour revenir au menu précédent.

Capteurs

Appuyer sur  Probes pour paramétrer les avertissements et les retards ou le point de rosée minimum/maximum.

Code	Description	Unité
A6	Warning high dew point	0.0 °C
A8	Delay warning high dew point	0'
A9	Warning low dew point	0.0 °C
A10	Delay warning low dew point	0 s

Purgeur de l'eau de condensation

Appuyer sur  pour ouvrir le menu Purgeur de l'eau de condensation. pour fixer:

1. Purgeur temporisé (avec choix des heures de fermeture et d'ouverture) ;
2. Purgeur capacitif ;
3. Purgeur continu (purgeur externe).

Appuyer sur  pour revenir au menu précédent.

Condensate drain

D3  Modality Continuos

Configuration

Appuyer sur  Configuration pour ouvrir l'écran de configuration avec le menu suivant :

1. Choix de l'affichage de température en °C / °F ;
2. Activation du démarrage à distance ;
3. Activation des alarmes uniquement ou des alarmes / avertissements ;
4. Rétablissement des paramètres par défaut.

Utiliser le bouton pour fermer la description et faire son choix.

 Pour gérer le mode REMOTE OFF, retirer le pont entre les bornes : 87-92 et brancher l'interrupteur marche/arrêt à distance (à prévoir par le client).

Configuration

A1	Change °C to °F	°C
A7	Remote ON/OFF	DISABLED
xJ1	Alarm mode	ALARM + WARNING
DEF	Default values	DEF

Maintenance

Appuyer sur  pour afficher les heures de fonctionnement du compresseur/dessiccateur.

Appuyer sur  pour revenir au menu précédent.

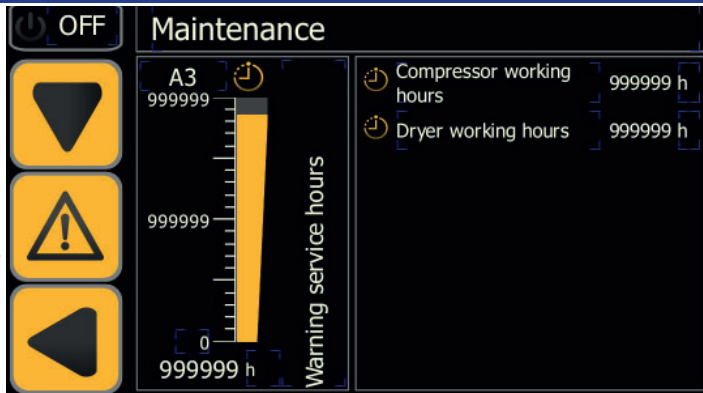

Fonctionnement

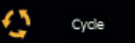
Appuyer sur  pour choisir le type de fonctionnement : continu ; cycle (économie d'énergie).

Touchez le paramètre pour effectuer le réglage.

Appuyer sur  pour revenir au menu précédent.

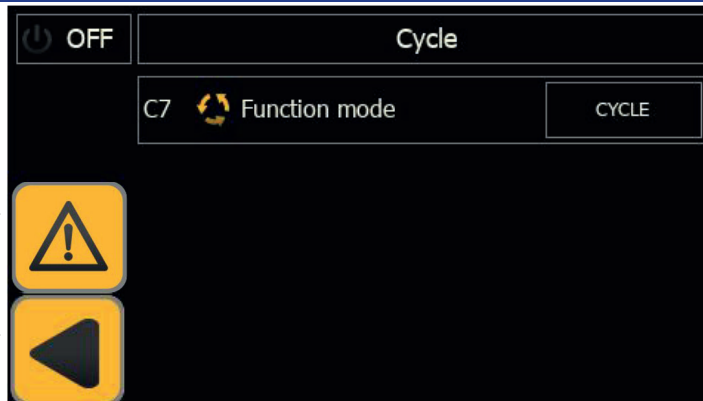

Modbus

Appuyer sur  pour régler les paramètres Modbus.
MODBUS RTU
(RS485)

Appuyer sur  pour passer à la page suivante.

MODBUS TCP/IP

Appuyer sur  pour revenir au menu précédent.

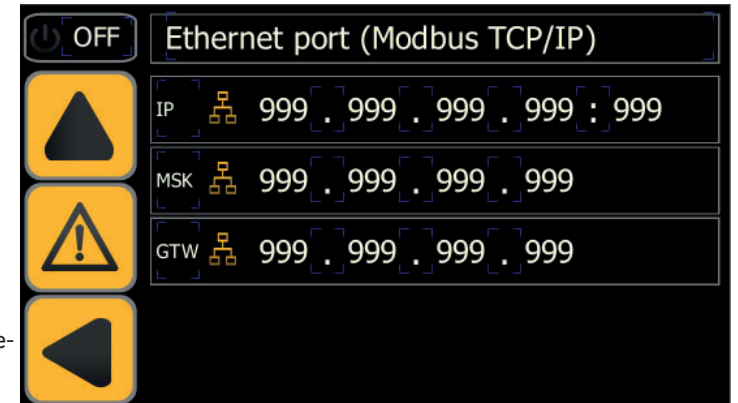
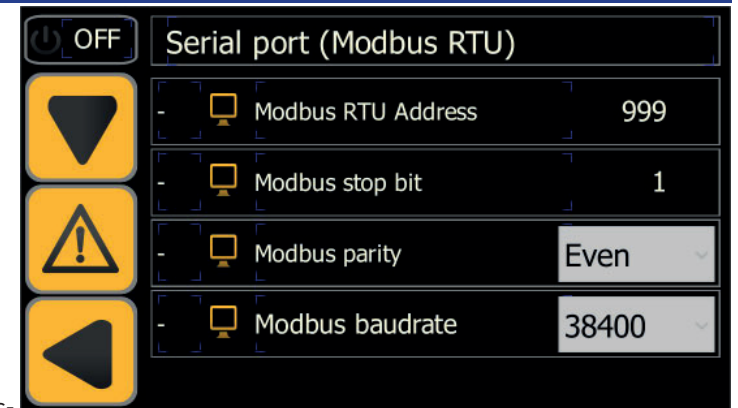

Éteignez/Allumez le dessiccateur pour confirmer la configuration.

Cloud

Appuyer sur  pour voir « password » pour le cloud.

Cette option est en cours.

Appuyer sur  pour revenir au menu précédent.



5.3 Alarmes/Avertissements

Appuyer sur  pour ouvrir le menu Alarmes/Avertissements.

Touchez « durée » pour modifier l'heure de la recherche.

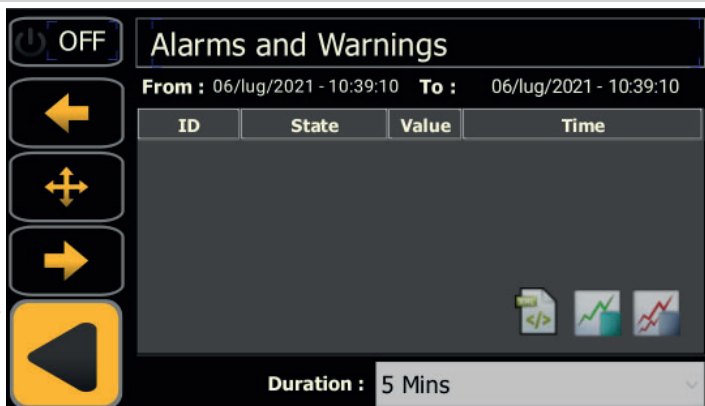

Après le rétablissement des conditions de fonctionnement nominales, certains avertissements et certaines alarmes sont réinitialisés automatiquement. D'autres doivent être réinitialisés manuellement.

Appuyer sur  pour réinitialiser l'alarme.

Appuyer sur  pour afficher l'historique des alarmes avec les informations suivantes :

code alarme, date, nombre d'alarmes, position dans l'ordre d'occurrence et date/heure d'activation des alarmes.

Appuyer sur  pour revenir au menu précédent.

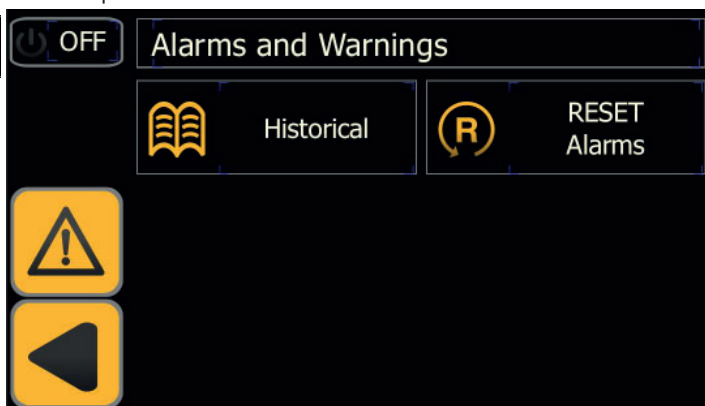

5.3.1 Liste des alarmes/avertissement

a = alarme; w = avertissement

Code	Alarme/Avertissement	Cause
aLD	alarme Bas point de rosée	température B0<A9 pour plus de A10 seconds.
aLT	alarme basse température d'évaporation.	température B2<A12 pour plus de A13 seconds
aHT2	alarme de température de refoulement élevée	température B8>A11
aHP	alarme haute pression	pressostat haute pression activé
aLP	alarme basse pression	pressostat basse pression activé
aLTA	alarme basse température multicooter	température B4<A12 pour plus de A13 seconds
aPI*	alarme Protection thermique compresseur.	protection thermique compresseur activé
aPH	alarme moniteur de phase	moniteur de phase activé (pour 460-750)
aCM1	alarme communication expansion 1	l'expansion 1 ne communique pas
aCM2	alarme communication expansion 2	l'expansion 2 ne communique pas
wB0	avertissement sonde B0	sonde cassée ou non connectée
wB2	avertissement sonde B2	sonde cassée ou non connectée
wB4	avertissement sonde B4	sonde cassée ou non connectée
wB5	avertissement sonde B5	sonde cassée ou non connectée
wB6	avertissement sonde B6	sonde cassée ou non connectée
wB8	avertissement sonde B8	sonde cassée ou non connectée
aFP1	alarme haute pression transmetteur P1	transmetteur cassée ou non connectée
wHD	avertissement haute point de rosée	température B0>A6 pour plus de A8 minutes
wHT1	avertissement de température de refoulement élevée	température B8>A14 pour plus de A15 minutes
wHP1	avertissement haute pression	pression P1>A16 pour plus de 2 seconds
wHB5	avertissement de température d'aspiration élevée	température B5>A18 pour plus de 1 minute
wLP2	avertissement basse pression	pression P2<A21 pour plus de 150 seconds
wSR	avertissement Entretien programmé	le temps de service défini a expiré
wDR1	avertissement purgeur de condensats 1	le condensat ne s'écoule pas du sécheur 1
wDR2	avertissement purgeur de condensats 2	le condensat ne s'écoule pas du sécheur 2
wDR3	avertissement purgeur de condensats 3	le condensat ne s'écoule pas du sécheur 3
aFP2	alarme basse pression transmetteur P2	transmetteur cassée ou non connectée

* pour les modèles de 900 à 1800, l'alarme peut également avoir la signification de phases inversées.

5.4 Menu Rapide

Ouvrir le menu en quelques étapes :

Afficher la température

Appuyer sur  → Appuyer sur  Appuyer sur la température pour afficher les graphiques

Afficher la pression

Appuyer sur  → Appuyer sur  Appuyer sur la pression pour afficher les graphiques.

Télécharger

Appuyer sur  → Appuyer sur  pour télécharger.



Date du numéro de série

Appuyer sur  → Appuyer sur  .



Modifier la langue

Appuyer sur  → Appuyer sur  → Appuyer sur  Choisir la langue.

Date/Temps

Appuyer sur  → Appuyer sur  → Appuyer sur  Mettre à jour l'horloge.

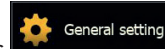
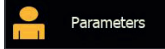
Modifier l'unité de mesure °C en °F, Remote, DEF



Appuyer sur  → Appuyer sur  → Appuyer sur  → Appuyer sur  :

Appuyer sur le paramètre °C ou °F pour effectuer la modification.

Activer / désactiver le paramètre **"Remote ON/OFF"** .

Touchez **"DEF"** pour restaurer le paramètre

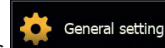
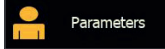

Passer en mode Cycle

Appuyer sur  → Appuyer sur  → Appuyer sur  → Appuyer sur  change the operation.

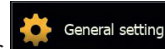
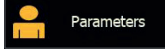
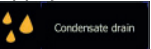
Purgeur

Appuyer sur  → Appuyer sur  → Appuyer sur  → Appuyer sur  Choisir le purgeur.

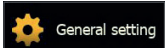
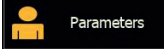

Modbus

Appuyer sur  → Appuyer sur  → Appuyer sur  → Appuyer sur 

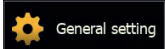
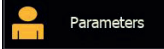
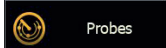
Réglage du paramètre

Appuyer sur  → Appuyer sur  → Appuyer sur  → Appuyer sur  modifier le paramètre.

Alarme / Avertissement

Appuyer sur  → Appuyer sur  pour trouver l'alarme historique et réinitialiser l'alarme.

Appuyer sur  pour afficher l'historique.

Appuyer sur  pour réinitialiser l'alarme.

6 Entretien

• La machine est conçue et fabriquée pour garantir un fonctionnement continu ; toutefois, la durée de vie de ses composants est directement liée à l'entretien effectué.

-  Pour toute demande d'assistance ou de pièces détachées, identifier la machine en communiquant le modèle et le numéro de série figurant sur la plaque signalétique apposée à l'extérieur de l'appareil.
- Les circuits contenant 5t < xx < 50t ou CO2 doivent être contrôlés au moins une fois par an pour vérifier l'absence de fuites éventuelles. Les circuits contenant 50t < xx < 500t ou CO2 doivent être contrôlés au moins une fois tous les six mois pour vérifier l'absence de fuites éventuelles. ((UE) N° 517/2014 art. 4.3.a, 4.3.b).
- Pour les machines contenant 5t CO2 ou plus, l'opérateur est tenu de consigner dans un registre la quantité et le type de fluide frigorigène utilisé, les quantités éventuellement ajoutées et celles qui ont été collectées au cours des opérations d'entretien, de réparation et de mise au rebut ((UE) N° 517/2014 art. 6).

6.1 Recommandations générales

 Avant toute opération d'entretien, s'assurer que :

- le circuit d'air comprimé n'est plus sous pression ;
- que le sécheur soit débranché du réseau d'alimentation électrique.

 En cas de fuite du réfrigérant, appeler un professionnel qualifié et agréé par le constructeur.

 Utiliser toujours des pièces de rechange d'origine ; dans le cas contraire, le constructeur est déchargé de toute responsabilité pour le mauvais fonctionnement de la machine

 La vanne ou valve Schrader ne doit être utilisée qu'en cas d'anomalie de fonctionnement de la machine : dans le cas contraire, les dommages causés par une charge de réfrigérant incorrecte ne seront pas reconnus au titre de la garantie.

6.2 Réfrigérant















Opération de charge : les dommages éventuels causés par une charge incorrecte de réfrigérant effectuée par un personnel non habilité ne seront pas reconnus au titre de la garantie. 

 L'appareil contient des gaz à effet de serre fluorés.

Le fluide frigorigène R513A à température et pression normales est un gaz incolore appartenant au SAFETY GROUP A1 - EN378 (fluide groupe 2 selon la directive PED 97/23/EC); GWP (Global Warming Potential) = 573.

6.3 Programme d'entretien préventif

Pour une efficacité et une fiabilité maximales durables du sécheur, effectuer :



Descrição das actividadesde manutenção	Intervalo de manutenção (em condições de funcionamento padrão)				
	Todos os dias	Todas as semanas	A cada 4 meses	Anualmente	A cada 36 meses
Actividade verificar  assistência 					
Contrôler que le témoin POWER ON est allumé					
Contrôler les indicateurs du tableau des commandes.					
Nettoyer le filtre de la vanne pressostatique à eau s'il n'est pas sale augmenter l'intervalle de contrôle (voir notice) (PSE750-1800)					
Contrôler le purgeur des condensats.					
Nettoyer les ailettes du condenseur					
Contrôler le positionnement correct de la résistance carter.					
Contrôler la consommation électrique.					
Contrôler les fuites de réfrigérant.					
Dépressurisation de l'installation. Effectuer l'entretien du purgeur.					
Dépressurisation de l'installation. Remplacer les éléments du préfiltre et du post-filtre.					
Contrôler les sondes de température. Remplacer si nécessaire.				 	
Kit d'entretien séchoir.					

Sont disponibles (voir paragraphe 8.4) :

- Kits d'entretien préventif 3 ans ;
- Kits d'entretien
 - kits compresseur ;
 - kits ventilateur ;
 - Kits soupape à gaz chaud;
 - Kits condenseur d'eau ;
- pièces détachées.

6.4 Mise au rebut

Le fluide frigorigène et le lubrifiant (huile) contenus dans le circuit devront être récupérés selon la législation antipollution. La récupération du fluide réfrigérant est effectuée avant la destruction définitive de l'équipement ((UE) N° 517/2014 art.8).

 Recyclage	 Recyclage Élimination
charpenterie (ossature)	acier/résines époxy-polyester
échangeur	aluminium
tuyauteries/collecteurs	cuivre/aluminium/acier au carbone
purgeur	polyamide
isolation échangeur	EPS (polystyrène fritté)
isolation tuyauteries	caoutchouc synthétique
compresseur	acier/cuivre/aluminium/huile
condenseur	cuivre/aluminium
réfrigérant	R513A
valves ou vannes	laiton
câbles électriques	cuivre/PVC

Les équipements contenant des composants électriques doivent être éliminés séparément avec les déchets électriques et électroniques conformément à la législation locale et en vigueur.



7 Dépannage

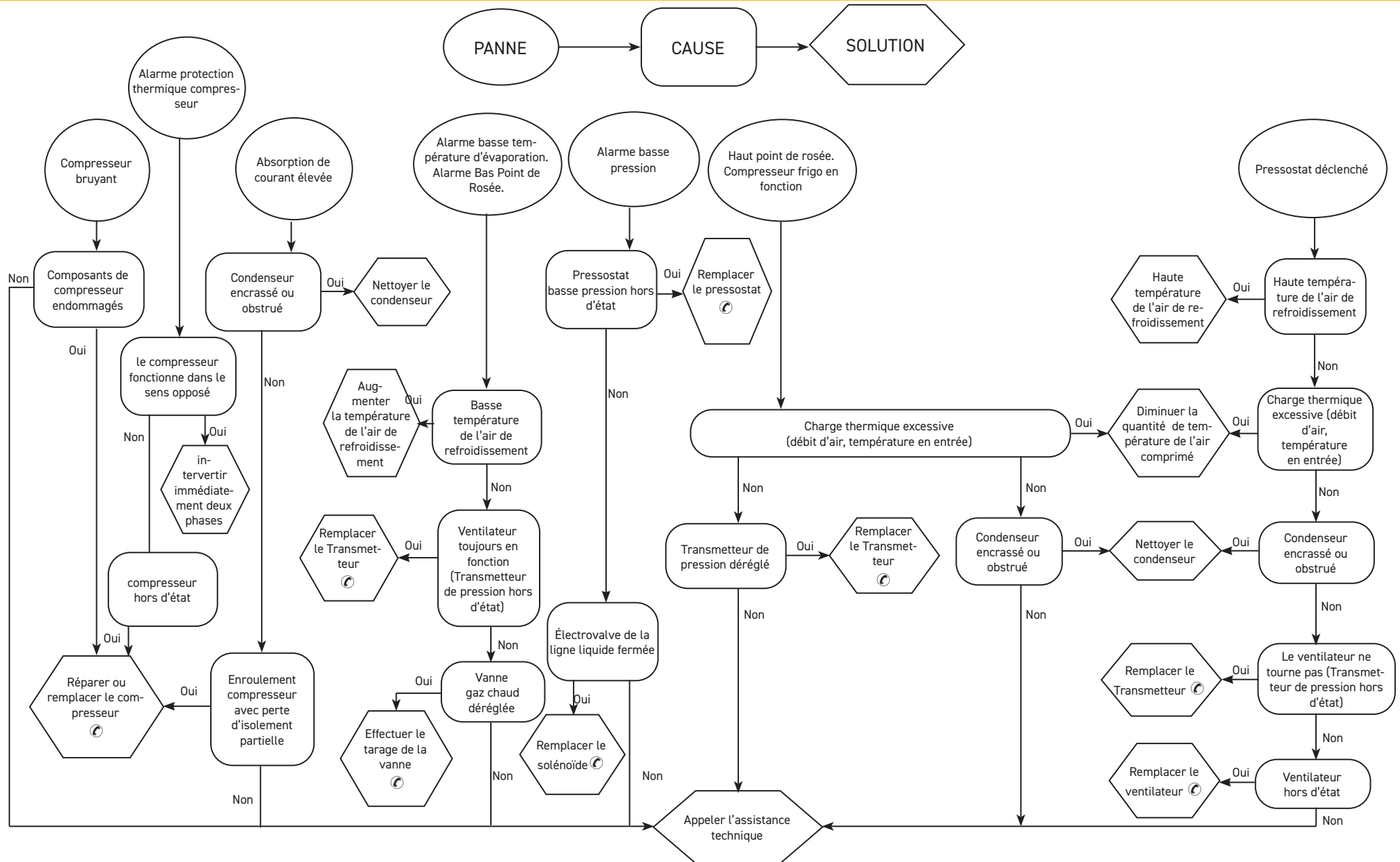

Inhaltsverzeichnis

1 SaSicherheit	1
1.1 Bedeutung des Handbuchs.....	1
1.2 Warn- und sonstige Hinweise.....	1
1.3 Sicherheitshinweise.....	1
1.4 Restrisiken.....	2
2 Einführung	2
2.1 Transport.....	2
2.2 Handhabung.....	2
2.3 Inspektion.....	2
2.4 Lagerung.....	2
3 Installation	3
3.1 Bedingungen.....	3
3.2 Betriebsbereich.....	3
3.3 Verflüssigerversion.....	3
3.4 Empfehlungen.....	3
3.5 Elektrischer Anschluss.....	3
3.6 Anschluss des Kondensatablasses.....	3
4 Inbetriebnahme	4
4.1 Vorab-Prüfungen.....	4
4.2 Starting.....	4
4.3 Betrieb.....	4
4.4 Stopp.....	4
5 Steuerung	5
5.1 Bedienkonsole.....	5
5.2 Hauptmenü.....	5
5.2.1 Maschinenstatus (I/O).....	5
5.2.2 Druck.....	6
5.2.3 Temperatur.....	6
5.2.6 Allgemeines.....	7
5.2.6.1 Sprache.....	7
5.2.6.2 Datum/Uhrzeit.....	7
5.2.6.3 User Menü.....	8
5.2.6.4 Parameters.....	8
5.3 Alarmer/Warnungen.....	10
5.3.1 Verzeichnis der Alarmer/Warnhinweise.....	10
5.4 Schnellmenü.....	11
6 Wartung	12
6.1 Allgemeine Hinweise.....	12
6.2 Kältemittel.....	12
6.3 Wartungsprogramm.....	12
6.4 Entsorgung.....	13
7 Störungssuche	14
8 Anhang	

1 SaSicherheit

1.1 Bedeutung des Handbuchs

- Das Handbuch ist während der gesamten Lebensdauer der Einheit aufzubewahren.
- Vor der Ausführung von Schaltvorgängen usw. ist das Handbuch aufmerksam durchzulesen.
- Es können jederzeit Änderungen am Handbuch vorgenommen werden; für aktualisierte Informationen ist die Version an der Einheit einzusehen.

1.2 Warn- und sonstige Hinweise



Hinweis zur Vorbeugung von Gefahren für Personen.



Hinweis mit Anleitungen zur Vermeidung von Schäden an der Einheit.





Präsenz eines erfahrenen und autorisierten Technikers erforderlich.





Aufgeführte Symbole, deren Bedeutung im Abschnitt 8. beschrieben sind 8.1.

1.3 Sicherheitshinweise

 Jede Einheit ist mit einem elektrischen Trennschalter ausgestattet, damit Arbeiten unter Sicherheitsbedingungen ausgeführt werden können. Aus Sicherheitsgründen vor der Ausführung von Wartungsarbeiten den Strom immer mit diesem Trennschalter ausschalten.

 Das Handbuch richtet sich an Endbenutzer zur Ausführung von Arbeiten bei geschlossenen Schutzpaneelen. Arbeiten, bei denen es notwendig ist, die Paneele mit Werkzeug zu öffnen, dürfen nur von Fachpersonal ausgeführt werden.

 Nicht die auf dem Typenschild angegebenen Projektvorgaben überschreiten.

  Es obliegt dem Benutzer, Lasten zu vermeiden, die vom internen Ruhedruck abweichen. In Erdbebengebieten müssen für die Einheit passende Schutzmaßnahmen vorgesehen werden.

 Die Sicherheitsvorrichtungen des Druckluftkreislaufes sind vom Benutzer zu stellen

 Die Sicherheitseinrichtungen des Druckluftkreises sind entsprechend den technischen Eigenschaften der Anlage und den geltenden gesetzlichen Bestimmungen zu bemessen.

Der Anwender hat alle Anwendungsaspekte, in denen das Produkt installiert ist, zu prüfen und die entsprechenden industriellen Sicherheitsnormen sowie die für das Produkt geltenden Vorschriften einzuhalten, die im Bedienerhandbuch und sonstigen Unterlagen, die mit der Einheit geliefert werden, enthalten sind. Die Einheit ist ausschließlich für die Trocknung von Druckluft

einzusetzen.

Umbauten und Veränderungen, die eine andere Verwendung ermöglichen, sowie der Austausch von Bauteilen durch nicht autorisiertes Personal, befreit den Hersteller von jeglichen Haftungsansprüchen und führt zum Erlöschen der Garantie.

Der Hersteller übernimmt keinerlei Haftung, weder gegenwärtig noch zukünftig, für Personen- und Sachschäden sowie Beschädigungen der Einheit, die auf Nachlässigkeit der Bediener, die Nichteinhaltung aller im vorliegenden Handbuch aufgeführten Anleitungen und die Nichteinhaltung der gültigen Vorschriften für die Anlagensicherheit zurückzuführen sind.

Der Hersteller übernimmt keine Haftung für eventuell durch Austausch und/oder Änderung an der Verpackung entstandene Schäden.

Der Anwender hat sich zu vergewissern, dass die für die Auswahl der Anlage gelieferten Spezifikationen und/oder deren Bauteile und/oder Optionen für die korrekte bzw. in vernünftiger Weise vorhersehbare Nutzung der Anlage bzw. der Bauteile ausreichen.

 **ACHTUNG: Der Hersteller behält sich das Recht vor, die in dem vorliegenden Handbuch enthaltenen Informationen ohne Ankündigung zu ändern. Zur vollständigen und aktuellen Information wird empfohlen, sich an den Hersteller zu wenden**

1.4 Restrisiken

Die Installation, das Ein- und Ausschalten sowie die Wartung des Kältetrockners müssen unbedingt unter Beachtung der Vorgaben in der technischen Dokumentation des Produkts und mit Gewährleistung der Sicherheitsbedingungen zur Vermeidung bzw. Vorbeugung jeglicher Gefahren ausgeführt werden. Die Risiken, die in der Projektierungsphase nicht beseitigt werden konnten, sind in der nachfolgenden Tabelle aufgeführt.

Betreffende Teile	Restrisiko	Art und Weise	Vorsichtsmaßnahmen
Wärmetauscher	Kleine Schnittverletzungen	Kontakt	Kontakt vermeiden, Schutzhandschuhe anziehen.
Lüftungsgitter und Ventilator	Verletzungen	Einfügen von spitzen Gegenständen durch die Gitterschlitze während des Ventilatorbetriebs.	Keine Gegenstände jedweder Art in die Gitterschlitze der Ventilatoren einfügen oder auf die Gitter legen.
Innenbereich d.Einheit: Verdichter und druckseitige Leitung	Verbrennungen	Kontakt	Kontakt vermeiden, Schutzhandschuhe anziehen.
Innenbereich d.Einheit: Metallteile und Elektrokabel	Vergiftungen, Stromschläge schwere Verbrennungen	Defekt an der Isolierung der Versorgungskabel vor dem Schaltschrank der Einheit; Metallteile unter Spannung.	Geeigneter elektrischer Schutz der Versorgungsleitung; maximale Sorgfalt bei der Ausführung der Erdung für die Metallteile.
Außenbereich d. Einheit: umfangsseitig	Vergiftungen, schwere Verbrennungen	Brand infolge Kurzschluss oder Überhitzung der Versorgungsleitung vor dem Schaltschrank der Einheit.	Querschnitt der Kabel und Schutzsystem der elektrischen Versorgungsleitung gemäß den einschlägigen Normen ausführen.

2 Einführung

Dieses Handbuch bezieht sich auf Kältetrockner, mit denen Wasserdampf aus der Druckluft entfernt werden kann.

2.1 Transport

Die verpackte Einheit muss:

- Stets in vertikaler Position transportiert werden;
- Gegen witterungsbedingte Einflüsse geschützt werden;
- Gegen Stöße geschützt werden.

2.2 Handhabung

Einen für das anzuhebende Gewicht geeigneten Gabelstapler verwenden und bei der Handhabung jegliche Stöße vermeiden.

2.3 Inspektion

- Alle Einheiten werden im Werk zusammengebaut, verkabelt, mit Kältemittel und Öl befüllt und unter Standard-Betriebsbedingungen der Abnahmeprüfung unterzogen.
- Bei der Anlieferung der Einheit ist deren Zustand zu überprüfen; eventuelle Schäden sind unverzüglich dem Transportunternehmen zu melden.
- Das Auspacken der Einheit möglichst nahe am Installationsort ausführen.

2.4 Lagerung

Falls erforderlich, mehrere Einheiten übereinander stapeln, hierzu jedoch die Hinweise auf der Verpackung beachten. Die verpackte Einheit an einem sauberen Ort aufbewahren, der gegen Feuchtigkeit und witterungsbedingte Einflüsse geschützt ist.

3 Installation

☞ Installieren Sie das Gerät in Innenräumen an einem sauberen, trockenen Ort, der vor Witterungseinflüssen, direkter Sonneneinstrahlung und / oder anderen rauen Bedingungen geschützt ist.

⚠ Das installierte Produkt muss angemessen gegen Brandgefahr geschützt sein (Ref. EN378-3).

3.1 Bedingungen

⚠ Dass die Stiftschrauben bis zum Endanschlag in die Flanschen eingedreht werden, bevor der Anschluss der Gegenflanschen erfolgt (siehe Abschnitt 8.6).

☞ Halten Sie sich an die Anweisungen in den Abschnitten 8.2 und 8.3.

Alle Trockner müssen mit geeigneten Vorfiltern nahe dem Lufteintritt ausgestattet sein.

Der Hersteller ist von allen Schadenersatz- sowie Rückzahlungsforderungen, welche auf Schäden die direkt oder indirekt auf eine fehlende Vorfiltration zurückzuführen sind, befreit.

☞ Das Vorfilterelement (mit Filterleistung bis 3 Mikron oder niedriger) sollte mindestens einmal jährlich oder in den vom Hersteller vorgeschriebenen Zeitabständen ausgewechselt werden.

☞ Die Trocknereinheit korrekt mit den Anschlüssen für den Ein- und Austritt der Druckluft verbinden.

3.2 Betriebsbereich

☞ Umfangsseitig um die Einheit ist ein Freiraum von 1,5 m erforderlich.

Bei Trocknermodellen mit vertikalem Ausstoß der Kondensationsluft ist oberhalb der Einheit ein Freiraum von 2 m erforderlich..

3.3 Verflüssigerversion

Luftgekühlte Version (Ac)

Sicherstellen, dass keine Rückzirkulationen der Kühlluft auftreten können.

Auf keinen Fall die Lüftungsgitter bedecken.

Wassergekühlte Version (Wc)

Falls in der Lieferung nicht vorgesehen, einen Siebfilter am Einlauf des kühlwasser installieren.

☞  Eigenschaften des kühlwasser am Einlauf:

Temperatur	≥50°F (10°C)	CL ⁻	<50 ppm
ΔT IN/OUT	5-15°C	CaCO ₃	70-150 ppm
Max % Glykole	50	O ₂	<0.1 ppm
Druck	43.5-145 PSig (3-10 barg)	Fe	<0.2 ppm
PH	7.5-9	NO ₃	<2 ppm
Elektrische Leitfähigkeit	10-500 μS/cm	HCO ₃ ⁻	70-300 ppm
Langelier- Sättigungsindex	0-1	H ₂ S	<0.05 ppm
SO ₄ ²⁻	<50 ppm	CO ₂	<5 ppm
NH ₃	<1 ppm	Al	<0.2 ppm

Für besonderes Kühlwasser (entionisiertes, entmineralisiertes oder destilliertes Wasser) sind die für den Kondensator vorgesehenen Standardmaterialien u. U. nicht geeignet. In diesem Fall bitte vorher

Rücksprache mit dem Hersteller halten.

3.4 Empfehlungen

Zur Vermeidung von Schäden an den internen Komponenten des Trockners und des Luftverdichters ist von der Installation in Bereichen abzusehen, in denen die Luft feste und/oder gasförmige kontaminierende Stoffe enthält, z.B. Schwefel, Ammoniak, Chlor; hierzu zählen auch meeresnahe Bereiche. Bei den Ausführungen mit Axialventilatoren wird von der Kanalisierung der Abluft abgeraten.

3.5 Elektrischer Anschluss

Für den elektrischen Anschluss ist ein typengeprüftes Kabel gemäß den Gesetzes- und Normvorgaben des jeweiligen Installationsorts zu verwenden (bezüglich des Kabel-Mindestquerschnitts siehe Abschnitt 8.3).

Installieren Sie einen externen FI-Schutzschalter. (RCCB - IDn = 0.3A); der Abstand zwischen den Kontakten im geöffneten Zustand muß 3 mm betragen (siehe einschlägige Normvorgaben des jeweiligen Installationsorts).

Der Nennstrom „In“ des Schutzschalters muss der maximalen Stromaufnahme entsprechen und die Auslösekennlinie muss vom Typ D sein.

Wählen Sie das Netzteil aus und setzen Sie eine Brücke wie unten gezeigt ein:

S7-S6 für 400/3/50

S8-S6 für 460/3/60

In der Schalttafel befindet sich ein Hinweisschild.

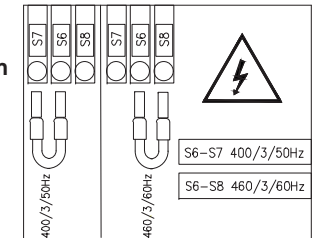

3.6 Anschluss des Kondensatablasses

☞ Den Anschluss an das Ablasssystem vornehmen, jedoch vermeiden, dass dieser im geschlossenen Kreis zusammen mit anderen unter Druck stehenden Ablassleitungen ausgeführt wird. Überprüfen, ob der Abfluss des Kondensats korrekt erfolgt. Das gesamte Kondensat gemäß den einschlägigen Umweltschutzvorgaben des jeweiligen Installationsorts entsorgen.

4 Inbetriebnahme

4.1 Vorab-Prüfungen

Stellen Sie vor der Inbetriebnahme des Trockners Folgendes sicher:

- die Installation wurde gemäß den Anweisungen aus Abschnitt 3 korrekt durchgeführt;
- die Lufteinlassventile sind geschlossen und es gibt keinen Luftstrom im Trockner;
- die Stromversorgung ist korrekt;
- der Kühlwasserkreislauf wird einige Minuten vor dem Start des Trockners geöffnet (bei der wassergekühlten Version).

4.2 Starting

1. schalten Sie die Stromversorgung ein, indem Sie

den HAUPTSCHALTER  "auf „I ON“ drehen. erscheinen diese Informationen::

 **DIE VERSORGUNG DER KURBELWANNENHEIZUNG IST 12 STUNDEN VOR DER EINSCHALTUNG DES TROCKNERS FREIZUGEBEN.**

Berühren Sie anschließend , um auf dem Bedienfeld aufzurufen.

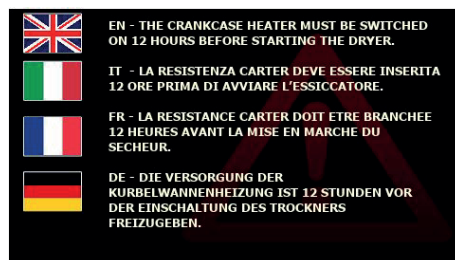

2. Berühren Sie zum Starten  die Farbe der Schaltfläche wechselt von grau zu grün, um zu sig-

nalisisieren, dass der Trockner jetzt in Betrieb ist .

3. Starten Sie den Trockner vor dem Luftkompressor;
Die Nichtbeachtung dieser Regel kann zu schweren Schäden am Kompressor führen.

 Gebläse (luftgekühlte Version): Beim Anschluss mit falscher Phasenfolge dreht sich das Gebläse in die entgegengesetzte Richtung, dabei besteht die Gefahr einer Beschädigung (in diesem Fall tritt die Luft aus dem Trockenschrank aus den Kondensatorgittern statt aus dem Ventilatorgitter aus - siehe Abschnitt 8.6 und 8.7 für den korrekten Luftstrom); sofort zwei Phasen tauschen.

4. Warten Sie 5 Minuten und öffnen Sie dann langsam das Lufteinlassventil;
5. öffnen Sie langsam das Luftauslassventil: Der Trockner trocknet jetzt.

Phasenüberwachung

Wenn während der Inbetriebnahme des Trockners der Alarm „Phasenüberwachung“ angezeigt wird, muss der Benutzer die Verdrahtung der Eingangsklemmen des Trennschalters des Trockners überprüfen.



4.3 Betrieb

- Lassen Sie den Trockner während der gesamten Dauer, in welcher der Luftkompressor arbeitet, eingeschaltet;
- der Trockner arbeitet im automatischen Modus, aus diesem Grund sind keine Feld-Einstellungen erforderlich;
- sollte es zu unvorhergesehenen Überschuss-Luftströmen kommen, schalten Sie zur Vermeidung einer Überlastung des Trockners auf den Bypass um.

- Vermeiden Sie Schwankungen der Zulufttemperatur.

4.4 Stopp

1. Stoppen Sie den Trockner 2 Minuten nach dem Stoppen des Luftkompressors, in jedem Fall aber nach der Unterbrechung des Luftstroms;
2. stellen Sie sicher, dass keine Druckluft in den Trockner gelangt, wenn der Trockner abgeschaltet ist oder wenn ein Alarm auftritt.

3. Drücken Sie  um den Trockner auszuschalten. Die Farbe in Grau der Schaltfläche wechselt zu grau. 

4. Drehen Sie den HAUPTSCHALTER "  " auf „O OFF“, um die Stromversorgung auszuschalten.

 Schließen Sie bei der wassergekühlten Version den Wasserkreislauf, wenn der Trockner nicht läuft.

5 Steuerung

5.1 Bedienkonsole

25/giu/2021 - 11:04:39

FS 0% HGBV 0% ECO 0%

0.0 °C PDP

MANUAL DRAIN

Schaltflächen	Funktion
	Trockner AUS (grau)
	Trockner EIN (grün)

LOCAL = Lokal Konfiguration
REMOTE = Fernbedienung Konfig.

Funktion	Schaltflächen	Funktion
FS 48 % Gebläse-Betriebsgeschwindigkeit (nur für Luftkondensatorversion)		Zugriff auf das Informationsmenü: Maschinenstatus, Drücke, Temperaturen, allgemeine Einstellungen, Verbrauch, Benutzerpasswort
HGBV 14 % Betriebsrate des Heißgasventils		Grau = keine Alarm Rot = Hinweis Rot Aufblinkend = Alarm
ECO 0% Energie sparen% (Zyklus)		Trockner AUS = hellgrau Radfahren aktiv = grün blinkend Kompressor aktiv = hellblau
		grau = Kondensatablauf OFF grün = Kondensatablauf ON

Funktion	Schaltflächen	Funktion				
Taupunkt Trend 8.0 °C PDP		Berühren Sie: zur manuelle Ableitung				
		<table border="1"> <thead> <tr> <th>Funktion</th> </tr> </thead> <tbody> <tr> <td> Strep led: blau = Kompressor aktiv</td> </tr> <tr> <td> grün = Energie sparen</td> </tr> <tr> <td> Rot = Alarm</td> </tr> </tbody> </table>	Funktion	Strep led: blau = Kompressor aktiv	grün = Energie sparen	Rot = Alarm
Funktion						
Strep led: blau = Kompressor aktiv						
grün = Energie sparen						
Rot = Alarm						

5.2 Hauptmenü

Berühren Sie um auf das Menü „Informationen“ zuzugreifen.

Wenn eine der „Berührungsschaltflächen“ berührt wird, leuchtet der Umriss einige Sekunden lang auf, um zu bestätigen, dass die Auswahl getroffen wurde.

Dies gilt für alle „Berührungsschaltflächen“, die auf dem Bedienfeld vorhanden sind.

Berühren Sie um zu Bedienkonsole

OFF

- Temperatures
- Pressures
- Status of I/O
- Serial Number
- USB Save data
- General setting

5.2.1 Maschinenstatus (I/O)

Berühren Sie um auf das Menü „Maschinenstatus“ zuzugreifen. Hier sind die Eingänge aufgelistet: Eine LED in der Nähe der Beschreibung zeigt den Zustand der Schutzvorrichtungen / Funktionen / Konfigurationen an: aktiv = grün nicht aktiv = grau

Berühren Sie um die nächste Seite aufzurufen. Hier sind die Ausgänge aufgelistet:

OFF

Status of Input

- High pressure switch
- Low pressure switch
- Thermal protection compressor
- Thermal protection fan
- Phases sequence control
- Dryer remote control
- Condensate level 1
- Condensate level 2
- Condensate level 3

Berühren Sie um zum vorherigen Menü zurückzukehren.

OFF

Status of Output



- Plant status ON
- General Alarm
- Compressor ON
- Fan ON
- Liquid solenoid valve
- Condensate drain 1
- Condensate drain 2
- Condensate drain 3

5.2.2 Druck

Drücken Sie  um das Menü „Druck“ aufzurufen und die folgenden Werte anzuzeigen: Verflüssigungsdruck, Gebläse-Betriebsrate, Verdampfungsdruck, Betriebsrate des Heißgasventils.



Berühren Sie einen bestimmten Parameter, um dessen Datentrend im Zeitverlauf anzuzeigen. z. B.

„Verflüssigungs-/Verdampfungsdruck“

Verwenden Sie  und  um die Kurve nach rechts oder links zu verschieben.

Berühren Sie  um zum vorherigen Menü zurückzukehren.

„Betriebsrate Gebläse/Heißgasventil“

Verwenden Sie  und  um die Kurve nach rechts oder links zu verschieben.

Berühren Sie  um zum vorherigen Menü zurückzukehren.

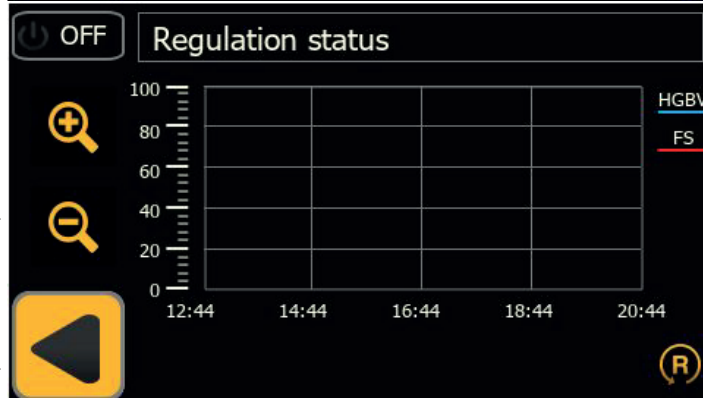
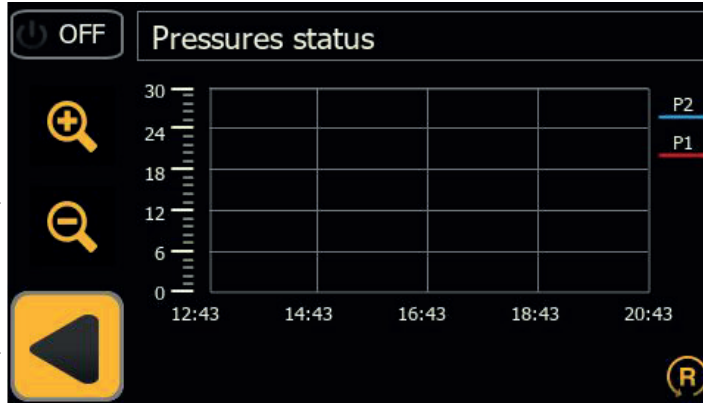
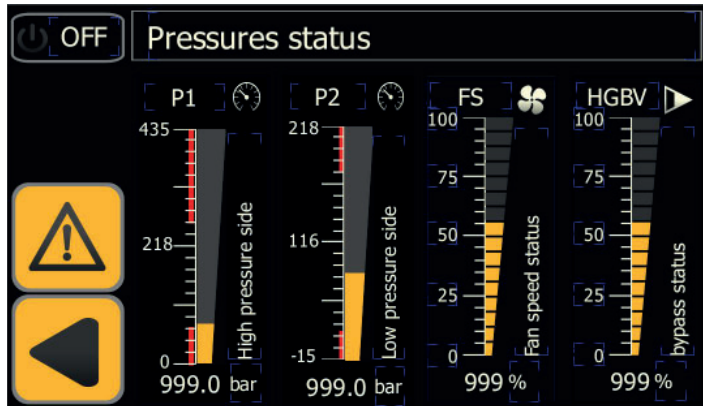

5.2.3 Temperatur

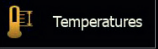
Drücken Sie  um die Temperaturmesswerte der Temperaturfühler im Schaltplan anzuzeigen.



Berühren Sie  um die nächste Seite aufzurufen.

B4 = nur für Version aktiv multicooler.

Berühren Sie einen der Niederdrucktemperaturwerte, um einen Datentrend aller Sonden im Niederdruckkreis anzuzeigen.



Berühren Sie einen der Hochdrucktemperaturwerte, um einen Datentrend aller Sonden im Hochdruckkreis anzuzeigen

Temperatur - Niederdruckseite

Verwenden Sie  und  um die Kurve nach rechts oder links zu verschieben.

Berühren Sie  um zum vorherigen Menü zurückzukehren.

Temperatur - Hochdruckseite

Verwenden Sie  und  um die Kurve nach rechts oder links zu verschieben.

Berühren Sie  um zum vorherigen Menü zurückzukehren.

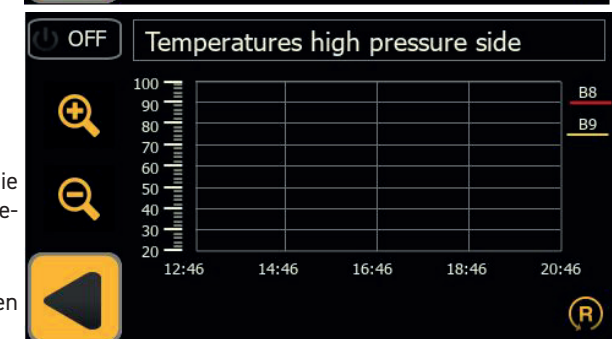
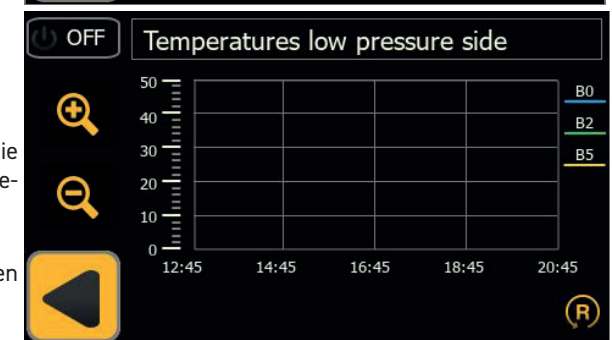
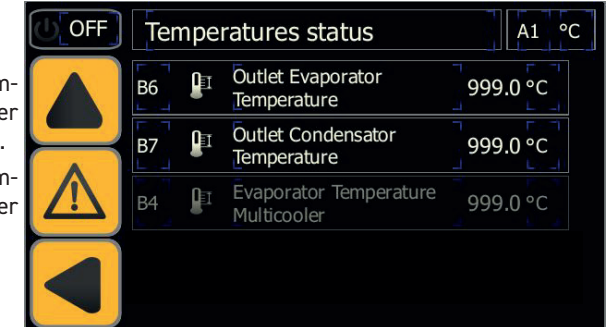
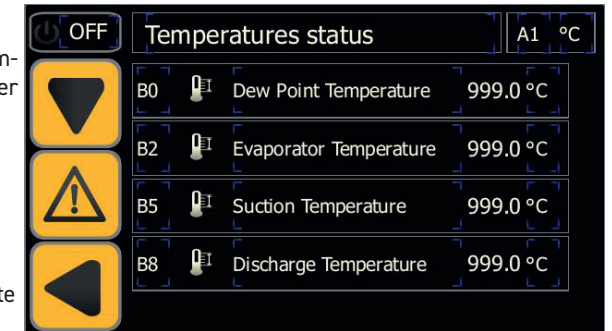

5.2.4 Herunterladen

Verwenden Sie einen USB mit LED, der Ihnen die Download-Phase anzeigt.
(8gB formatiert als FAT32) in die Frontplatte einlegen.

Drücken Sie  um den Download zu starten.
Die Zeit für das Herunterladen der Daten hängt von der Menge der gespeicherten Daten ab.



5.2.5 Seriennummern Daten

Drücken Sie  um auf das Menü „Serial number“ zuzugreifen.

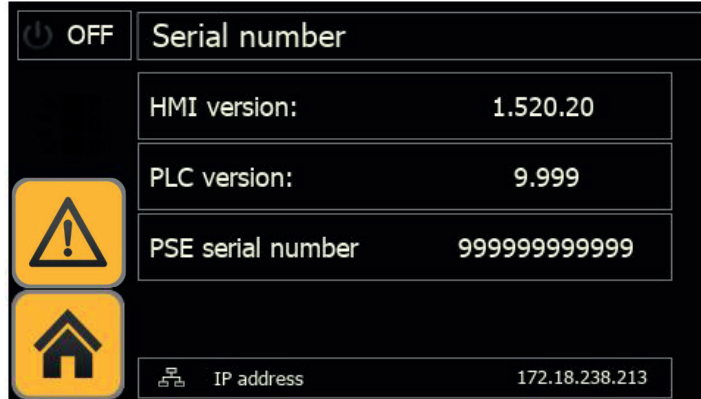

Drücken Sie  um zu Bedienkonsole

5.2.6 Allgemeines

Drücken Sie  um auf das Menü „Allgemein“ mit folgenden Abschnitten zuzugreifen: Sprache; Datum/ Uhrzeit; Parameter; Wartung; Zyklischer/kontinuierlicher Betrieb
Berühren Sie ein Menü, um es anzuzeigen / anzupassen.



Drücken Sie  um zu Bedienkonsole

5.2.6.1 Sprache

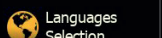
Drücken Sie  um auf das Menü „Sprache“ zuzugreifen.
Berühren Sie die gewünschte Sprache.
Die Sprache wird ausgewählt und Sie kehren automatisch zum Hauptmenü zurück.

Berühren Sie  um zum vorherigen Menü zurückzukehren.

Berühren Sie die gewünschte Sprache.
Die Sprache wird ausgewählt und Sie kehren automatisch zum Hauptmenü zurück.

Berühren Sie  um zum vorherigen Menü zurückzukehren.



5.2.6.2 Datum/Uhrzeit

Drücken Sie  um auf das Menü „Datum/ Uhrzeit“ zuzugreifen.

Berühren Sie Uhrzeit/Datum um mit der Änderung fortzufahren.

2 Sekunden lang drücken

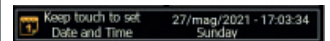

zur Bestätigung.

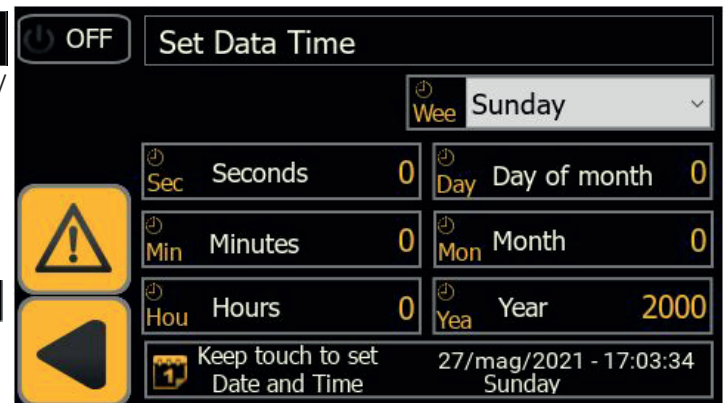

Berühren Sie  um zum vorherigen Menü zurückzukehren.

5.2.6.3 User Menü

Drücken Sie  Users access um auf das Menü "User".
Dieses Menü ist dem Servicetechniker von Parker vorbehalten.

User name:

Password:

Show password

5.2.6.4 Parameters

Drücken Sie  Parameters um auf das Menü „Parameter“ mit den folgenden Abschnitten zuzugreifen: Sonden, Kondensatablauf, Konfiguration, Wartung, Zyklus.
Berühren Sie die Schaltfläche, um auf das Menü zuzugreifen.



The Parameters menu is a grid of six items:

- OFF** (power icon)
- Probes** (thermometer icon)
- Maintenance** (wrench icon)
- Condensate drain** (water droplets icon)
- Configuration** (gear icon)
- Cycle** (circular arrows icon)
- Cloud Licence** (cloud icon)
- Communication setting** (antenna icon)

Navigation icons: a warning triangle (top left), a left arrow (bottom left), and a right arrow (bottom right).

Berühren Sie  um zum vorherigen Menü zurückzukehren.

Sonden

Drücken Sie  Probes um die Warnungen und Verzögerungen oder den minimalen/maximalen Taupunkt einzustellen.

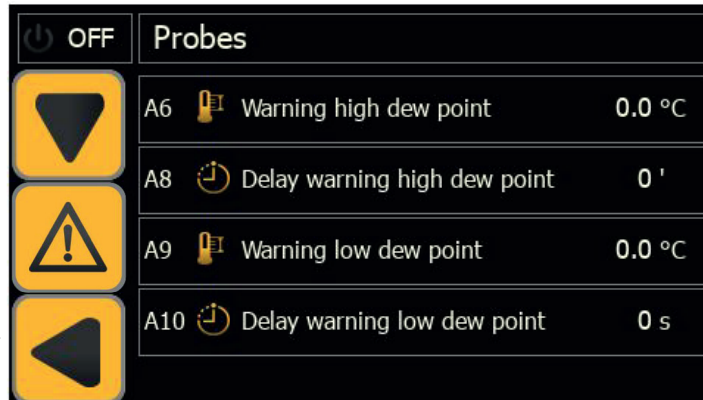

The Probes menu shows a list of settings:

Code	Description	Value
A6	Warning high dew point	0.0 °C
A8	Delay warning high dew point	0'
A9	Warning low dew point	0.0 °C
A10	Delay warning low dew point	0 s

Navigation icons: a left arrow (top left), a warning triangle (middle left), and a right arrow (bottom left).

Berühren Sie  um zum vorherigen Menü zurückzukehren.

Kondensatablauf

Drücken Sie  um auf das Menü „Kondensatablauf“ zuzugreifen.
Sie können wählen zwischen:

- zeitgesteuertem Ablauf (mit Festlegen der Öffnungs- und Schließzeiten);
- kapazitivem Ablauf;
- kontinuierlichem Ablauf (externem Ablauf).



The Condensate drain menu shows:

- OFF** (power icon)
- D3** (water droplets icon) Modality: **Continuos** (dropdown menu)
- Warning triangle icon
- Left arrow icon

Berühren Sie  um zum vorherigen Menü zurückzukehren.

Configuration

Drücken Sie  um die Konfigurationsanzeige mit den folgenden Menüpunkten aufzurufen:

- Auswahl der Temperaturanzeige °C / °F;
- Aktivierung der Fernsteuerung;
- Nur Alarme oder Alarme/Warnungen aktivieren;
- Zurücksetzen der Einstellungen auf die Standardparameter.

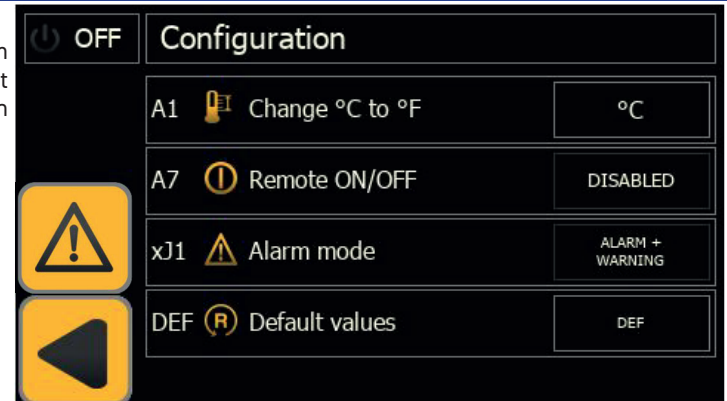

The Configuration menu shows:

- OFF** (power icon)
- A1** Change °C to °F: °C
- A7** Remote ON/OFF: DISABLED
- xJ1** Alarm mode: ALARM + WARNING
- DEF** Default values: DEF
- Warning triangle icon
- Left arrow icon

Berühren Sie die Schaltfläche neben der Beschreibung, um eine Auswahl zu treffen.

 Um den REMOTE OFF-Modus zu verwalten, entfernen Sie die Brücke zwischen den Klemmen: 87-92 und schließen Sie den Start-/Stopp-Fernschalter an (vom Kunden bereitzustellen).

Wartung

Drücken Sie  um die Betriebsstunden des Kompressors bzw. des Trockners anzuzeigen.

Berühren Sie  um zum vorherigen Menü zurückzukehren.

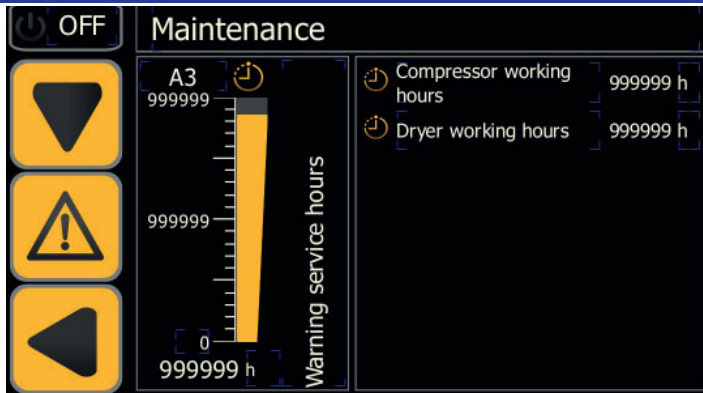

The screenshot shows the 'Maintenance' menu. At the top left is a power button labeled 'OFF'. Below it are three navigation buttons: a downward arrow, a warning triangle, and a leftward arrow. The main display area shows 'A3' with a clock icon and '999999' below it. To the right, there are two rows of data: 'Compressor working hours' and 'Dryer working hours', both showing '999999 h'. A vertical bar graph on the right is labeled 'Warning service hours' and has a scale from 0 to 999999 h.

Betrieb

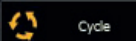
Drücken Sie  um die Betriebsart zu wählen: kontinuierlich; zyklisch (Energieeinsparung).

Berühren Sie die Schaltfläche neben der Beschreibung, um eine Auswahl zu treffen.

Berühren Sie  um zum vorherigen Menü zurückzukehren.

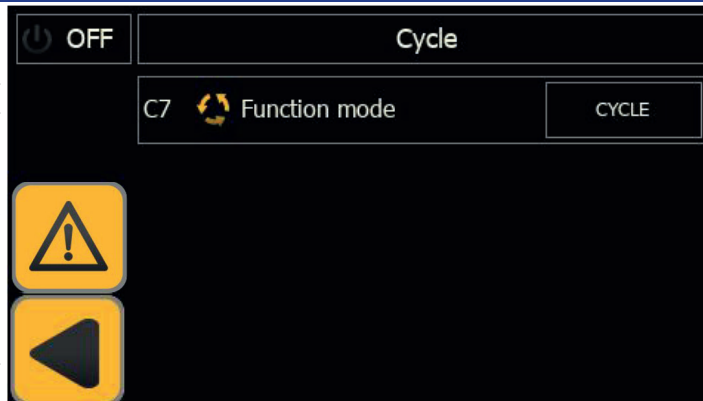

The screenshot shows the 'Cycle' menu. At the top left is a power button labeled 'OFF'. Below it are two navigation buttons: a warning triangle and a leftward arrow. The main display area shows 'C7' with a cycle icon and 'Function mode' next to it. A button labeled 'CYCLE' is on the right.

Modbus

Drücken Sie  um die Modbus-Parameter einzustellen.
MODBUS RTU
(RS485)

Berühren Sie  um die nächste Seite aufzurufen.

MODBUS TCP/IP

Berühren Sie  um zum vorherigen Menü zurückzukehren.

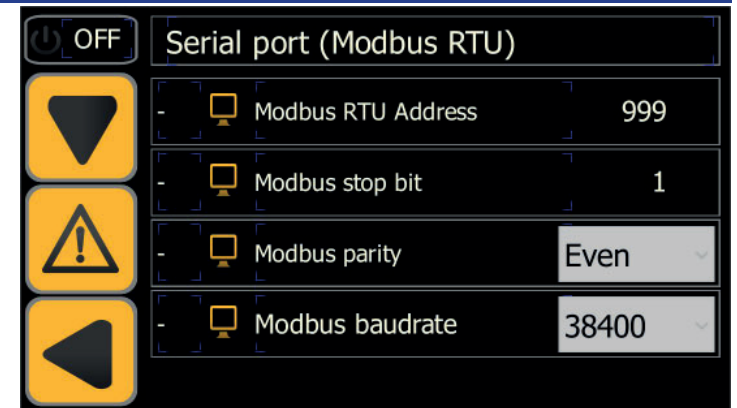

The screenshot shows the 'Serial port (Modbus RTU)' menu. At the top left is a power button labeled 'OFF'. Below it are three navigation buttons: a downward arrow, a warning triangle, and a leftward arrow. The main display area shows four rows of settings: 'Modbus RTU Address' set to '999', 'Modbus stop bit' set to '1', 'Modbus parity' set to 'Even', and 'Modbus baudrate' set to '38400'.

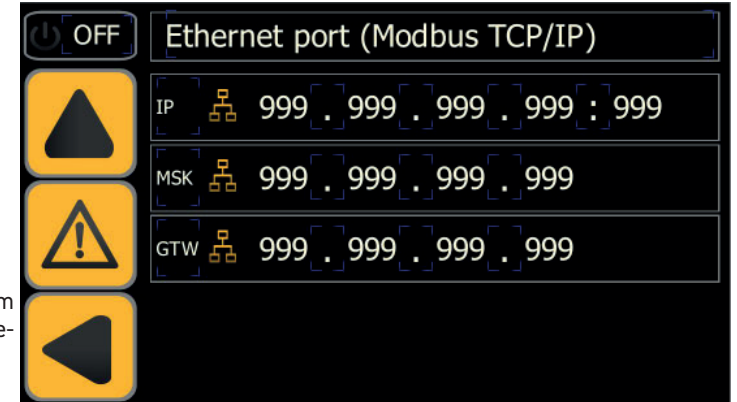

The screenshot shows the 'Ethernet port (Modbus TCP/IP)' menu. At the top left is a power button labeled 'OFF'. Below it are three navigation buttons: a warning triangle, a warning triangle, and a leftward arrow. The main display area shows three rows of settings: 'IP' set to '999 . 999 . 999 . 999 : 999', 'MSK' set to '999 . 999 . 999 . 999', and 'GTW' set to '999 . 999 . 999 . 999'.

Schalten Sie den Trockner AUS/EIN, um die Konfiguration zu bestätigen.

Cloud

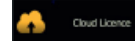
Drücken Sie  um „Passwort“ für die Cloud zu sehen.
Diese Option ist im Gange.

Berühren Sie  um zum vorherigen Menü zurückzukehren.



The screenshot shows the 'Cloud Licence' menu. At the top left is a power button labeled 'OFF'. Below it are two navigation buttons: a warning triangle and a leftward arrow. The main display area shows a password field with a cloud icon and the value '99999'.

5.3 Alarme/Warnungen

Drücken Sie  um auf das Menü „Alarme/Warnungen“ zuzugreifen:

Tippen Sie auf „duration“, um die Recherchezeit zu ändern.

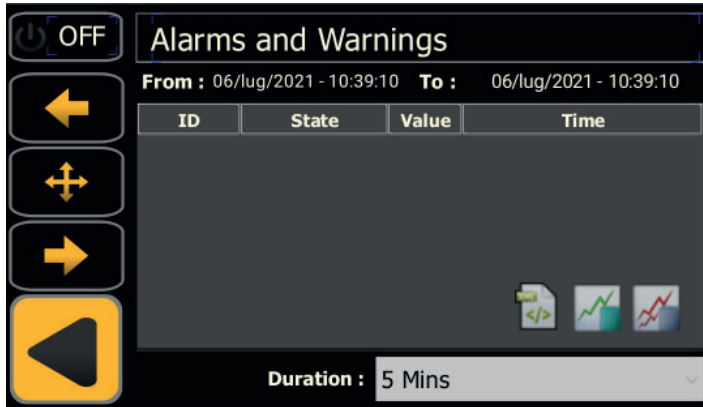

Nach Wiederherstellen der nominellen Betriebsbedingungen werden einige Warnungen und Alarme automatisch zurückgesetzt, andere Alarme/Warnungen müssen manuell zurückgesetzt werden..

Drücken Sie  um den Alarm zurückzusetzen.

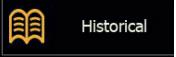
Drücken Sie  um das Alarm-Protokoll mit folgenden Werten anzuzeigen: Alarmcode, Datum, Anzahl der Alarme, Position in der Reihenfolge des Auftretens und die Zeit der Alarmauslösung.

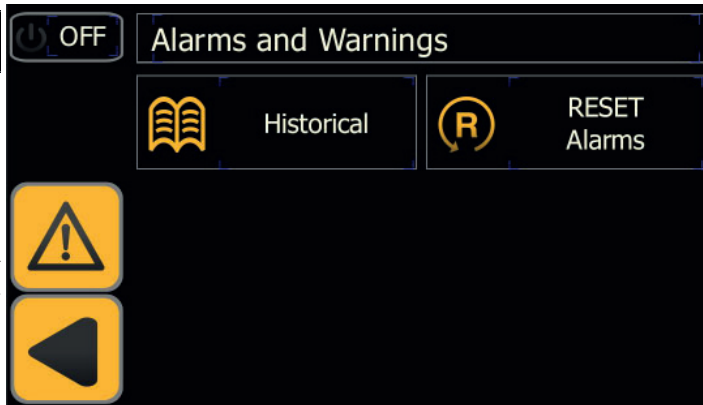

Berühren Sie  um zum vorherigen Menü zurückzukehren.

5.3.1 Verzeichnis der Alarme/Warnhinweise

a = Alarme; w = Warnhinweise

Code	Alarme/Warnungen	Grund
aLD	Alarm Niedriger Taupunkt	Temperatur B0<A9 für mehr als A10 Sekunden .
aLT	Alarm niedrige Verdampfertemperatur	Temperatur B2<A12 für mehr als A13 Sekunden
aHT2	Alarm vor zu hoher Austrittstemperatur	Temperatur B8>A11
aHP	Alarm Hochdruck	Hochdruckwächter aktiv
aLP	Alarm Niederdruck	Niederdruckwächter aktiv
aLTA	Alarm Niedertemperatur multicooter	Temperatur B4<A12 für mehr als A13 Sekunden
aPI*	Alarm Verdichter-Wärmeschutz	Verdichter-Wärmeschutz aktiv
aPH	Alarm Phasenmonitor	Phasenmonitor aktiv (für 460-750)
aCM1	Alarm Kommunikation Erweiterung 1	Erweiterung 1 kommuniziert nicht
aCM2	Alarm Kommunikation Erweiterung 2	Erweiterung 2 kommuniziert nicht
wB0	Warnhinweise Temperatursensor B0	Temperatursensor defekt oder nicht angeschlossen
wB2	Warnhinweise Temperatursensor B2	Temperatursensor defekt oder nicht angeschlossen
wB4	Warnhinweise Temperatursensor B4	Temperatursensor defekt oder nicht angeschlossen
wB5	Warnhinweise Temperatursensor B5	Temperatursensor defekt oder nicht angeschlossen
wB6	Warnhinweise Temperatursensor B6	Temperatursensor defekt oder nicht angeschlossen
wB8	Warnhinweise Temperatursensor B8	Temperatursensor defekt oder nicht angeschlossen
aFP1	Alarm Hochdruck HochDrucktransuktor P1	HochDrucktransuktor defekt oder nicht angeschlossen
wHD	Warnhinweise Hohe Taupunkt	Temperatur B0>A6 für mehr als A8 Minute
wHT1	Warnhinweise Hohe Kompressoraustrittstemperatur	Temperatur B8>A14 für mehr als A15 Minute
wHP1	Warnhinweise Hochdruck	Druck P1>A16 für mehr als 2 Sekunden
wHB5	Warnhinweise Hohe Saugseitetemperatur	Temperatur B5>A18 für mehr als 1 Minute
wLP2	Warnhinweise Niederdruck	Druck P2<A21 für mehr als 150 Sekunden
wSR	Warnung vor Servicezeiten	Die Servicezeit ist abgelaufen
wDR1	Warnhinweise Kondensatablasses 1	Das Kondensat wird nicht abgeführt cooler 1
wDR2	Warnhinweise Kondensatablasses 2	Das Kondensat wird nicht abgeführt cooler 2
wDR3	Warnhinweise Kondensatablasses 3	Das Kondensat wird nicht abgeführt cooler 3
aFP2	Alarm Niederdruck HochDrucktransuktor P2	HochDrucktransuktor defekt oder nicht angeschlossen

* für Modelle von 900-1800 könnte der Alarm auch die Bedeutung von invertierten Phasen haben.



5.4 Schnellmenü

Schneller Zugriff auf das Menü:

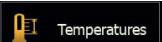
Temperatur anzeigen

Drücken Sie  → Drücken Sie  Berühren Sie die Temperatur, um die Diagramme anzuzeigen.

Druck anzeigen

Drücken Sie  → Drücken Sie  Berühren Sie die Temperatur, um die Diagramme anzuzeigen.

Herunterladen

Drücken Sie  → Drücken Sie  zum Herunterladen.

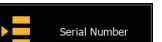

Seriennummern Daten

Drücken Sie  → Drücken Sie .

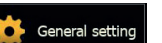

Sprache ändern

Drücken Sie  → Drücken Sie  → Drücken Sie  um Ihre Sprache auszuwählen.

Uhrzeit/Datum

Drücken Sie  → Drücken Sie  → Drücken Sie  Uhr aktualisieren.

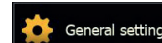
Ändern der Maßeinheit von °C auf °F, Remote, DEF

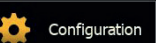

Drücken Sie  → Drücken Sie  → Drücken Sie  → Drücken Sie  :

Berühren Sie den Parameter „C“ oder „F“, um die Änderung vorzunehmen.

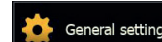

Fernsteuerung EIN/AUS aktivieren/deaktivieren.

Berühren Sie „DEF“, um den Parameter wiederherzustellen.

Umschalten auf zyklischen Betrieb

Drücken Sie  → Drücken Sie  → Drücken Sie  → Drücken Sie  um die Betriebsart zu ändern.

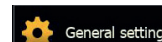

Ablauf

Drücken Sie  → Drücken Sie  → Drücken Sie  → Drücken Sie  um den Ablauf auszuwählen.

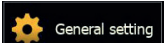
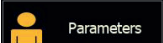
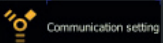
Modbus

Drücken Sie  → Drücken Sie  → Drücken Sie  → Drücken Sie 

Einstellungen im Parameter-Menü

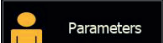
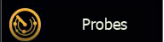
Drücken Sie  → Drücken Sie  → Drücken Sie  → Drücken Sie  um den Parameter zu ändern.

Alarm/Warnung

Drücken Sie  → Drücken Sie  historischen Alarm finden und Alarm zurücksetzen.

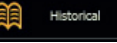
Drücken Sie  um Ihren historischen Alarm zu sehen.

Drücken Sie  um den Alarm zurückzusetzen.

6 Wartung

- Die Maschine ist für Dauerbetrieb konzipiert und gebaut; die Lebensdauer der einzelnen Komponenten hängt jedoch direkt von der ausgeführten Wartung ab.
-  Im Falle einer Kundendienst- oder Ersatzteilanforderung den Maschinentyp (Modell und Seriennummer) feststellen, der aus dem auf der Außenseite des Gerätes angebrachten Typenschild ersichtlich ist.
- Die Kreisläufe, die 5t < xx < 50t CO2 enthalten, sind mindestens einmal jährlich auf Kältemittelverluste zu kontrollieren.
Die Kreisläufe, die 50t < xx < 500t CO2 enthalten, sind mindestens einmal halbjährlich auf Kältemittelverluste zu kontrollieren ((EU) Nr. 517/2014, Art. 6).
- Für Maschinen, die 5t CO2 oder mehr enthalten, muss der Bediener ein Verzeichnis anlegen, in dem die Menge und der Typ des verwendeten Kältemittels, die eventuell aufgefüllte Menge und die bei der Wartung, bei Reparaturen und Entsorgung aufgefangenen Mengen eingetragen werden ((EU) Nr. 517/2014 Art. 6).

6.1 Allgemeine Hinweise

-  Vor der Ausführung von Wartungsarbeiten ist Folgendes sicherzustellen:
 - Der Druckluftkreis darf nicht mehr unter Druck stehen.
 - Die Stromversorgung des Trockners muß unterbrochen sein.

 Bei Verlust von Kältemittel ist erfahrenes und autorisiertes Fachpersonal zu kontaktieren.

 Stets Original-Ersatzteile des Herstellers verwenden; anderenfalls übernimmt der Hersteller keinerlei Haftung bei Fehlbedienung der Einheit.

 Das Schrader-Ventil ist nur im Fall eines von der Norm abweichenden Betriebs der Einheit einzusetzen; anderenfalls werden Schäden in Folge unkorrekter Kältemittelbefüllung nicht von der Garantie abgedeckt

6.2 Kältemittel













Auffüllen von Kältemittel: Für eventuelle Schäden durch fehlerhafte Befüllung mit Kältemittel durch unbefugtes Personal werden keine Garantieansprüche anerkannt. 

 Das Gerät enthält vom Kyoto-Protokoll erfasste fluorierte Treibhausgase. Das Kältemittel R513A ist unter Temperatur- und Druck-Standardbedingungen ein farbloses Gas mit Zugehörigkeit zur SAFETY GROUP A1 - EN378 (Flüchtigstoffgruppe 2 gemäß Druckgeräte-Richtlinie 2014/68/EU); GWP (Global Warming Potential) = 573.

 Bei Austritt von Kältemittel sind die betroffenen Räumlichkeiten zu lüften.

6.3 Wartungsprogramm

Zur langfristigen Gewährleistung maximaler Funktionstüchtigkeit und Zuverlässigkeit der Trocknereinheit ist Folgendes erforderlich:



Beschreibung der Wartungsarbeiten	Wartungszeitraum (unter Standardbetriebsbedingungen)				
	Täglich	Wöchentlich	Alle 4 Monate	Alle 12 Monate	Alle 36 Monate
Arbeit					
Kontrolle  Wartungsdienst 					
Kontrollieren, ob die Betriebsanzeige POWER ON leuchtet.					
Die Anzeigen der Bedientafel kontrollieren.					
Reinigen Sie den Filter des Druckgeregeltes Ventil für Wasser. Wenn er nicht verschmutzt ist, verlängern Sie das Inspektionsintervall (siehe Anweisungen).(PSE750-1800)					
Den Kondensatablauf kontrollieren.					
Die Kondensatorrippen reinigen.					
Korrekte Position und Funktion des Heizwiderstands am Gehäuse kontrollieren.					
Die Stromaufnahme prüfen.					
Die Anlage auf Kältemittelverluste kontrollieren.					
Anlage drucklos machen. Ableiterwartung durchführen.					
Anlage drucklos machen. Vor-und Nachfilterelemente austauschen.					
Die Temperaturfühler kontrollieren. Bei Bedarf austauschen.				 	
Wartungsbausatz Trockner.					

Folgende Wartungskits sind lieferbar (siehe Abschnitt 8.4):

- 3-Jahresbausätze für vorbeugende Wartungen;
- Service-kit:
 - Kompressor-kit;
 - Ventilator-kit;
 - Heißgasventil-kit;
 - Wasserkondensator-kit.
- Einzel Ersatzteile

6.4 Entsorgung

Kältemittel und Öl, die im Kältekreis enthalten sind, müssen nach den einschlägigen Umweltschutznormen des jeweiligen Installationsorts aufgefangen und entsorgt werden. Das Auffangen des Kältemittels erfolgt vor der endgültigen Verschrottung des Geräts ((EU) Nr. 517/2014, Art. 8).

	Recycling Entsorgung 
Struktur	Stahl/Epoxidharze-Polyester
Wärmetauscher	Aluminium
Leitungen/Sammelgehäuse	Kupfer/Aluminium/Kohlenstahl
Ablassvorrichtung	Polyamide
Wärmetauscher-Isolierung	EPS (gesintertes Polystyrol)
Isolierung der Leitungen	synthetisches Gummi
Verdichter	Stahl/Kupfer/Aluminium/Öl
Kondensator	Kupfer/Aluminium
Kältemittel	R513A
Ventile	Messing
Elektrokabel	Kupfer/PVC

Geräte, die elektrische Komponenten enthalten, müssen gemäß den örtlichen und aktuellen Gesetzen getrennt mit Elektro- und Elektronikschrott entsorgt werden.



7 Störungssuche

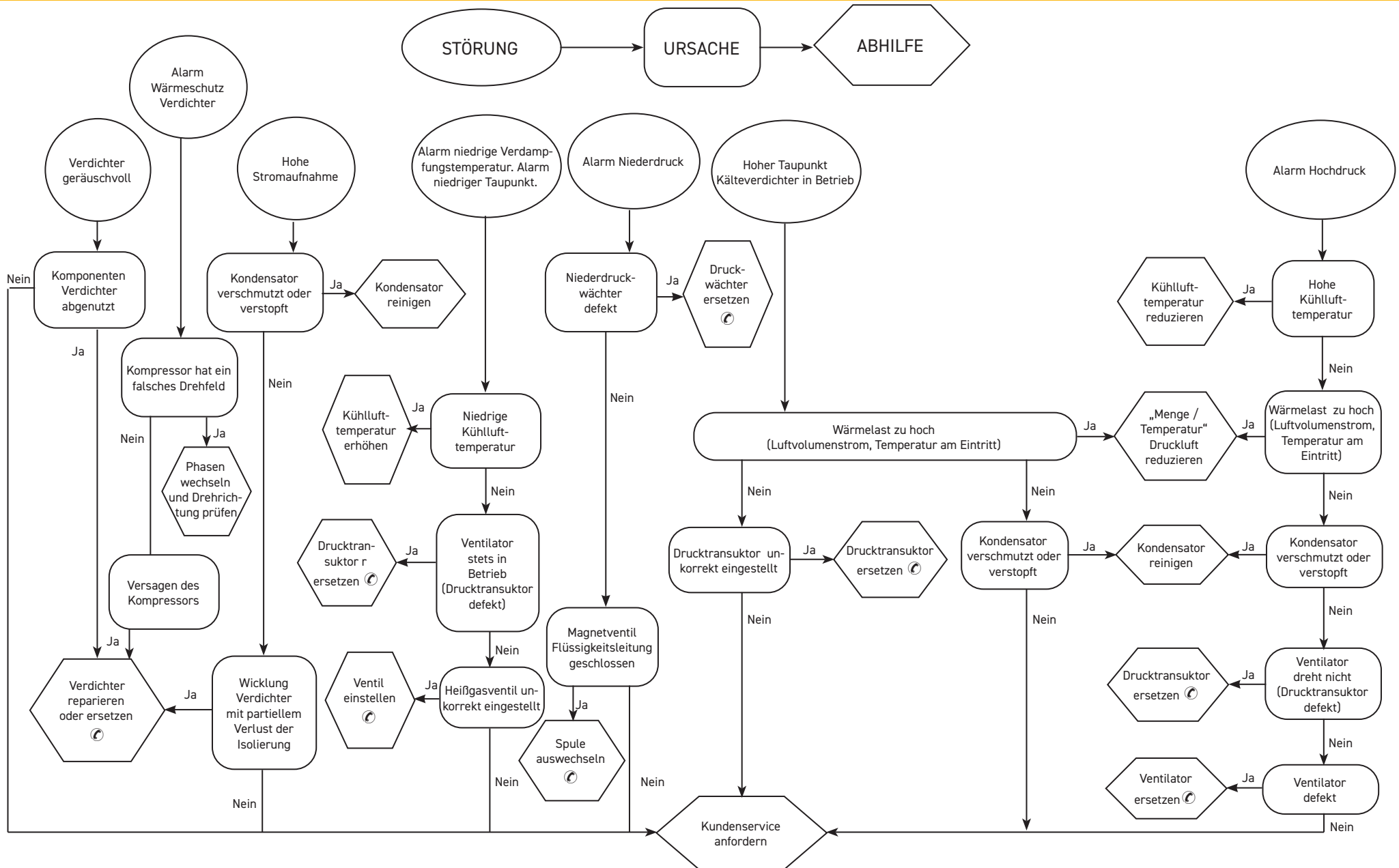

Índice

1 Segurança	1
1.1 Importância do manual	1
1.2 Sinais de aviso	1
1.3 Indicações de segurança.....	1
1.4 Riscos residuais.....	2
2 Introdução	2
2.1 Transporte	2
2.2 Movimentação	2
2.3 Inspeção	2
2.4 Armazenamento.....	2
3 Instalação	3
3.1 Modo.....	3
3.2 Espaço operativo	3
3.3 Versão condensador.....	3
3.4 Sugestões.....	3
3.5 Ligação eléctrica.....	3
3.6 Ligação da descarga de condensação	3
4 Colocação em funcionamento	4
4.1 Verificações preliminares	4
4.2 Arranque	4
4.3 Funcionamento	4
4.4 Paragem.....	4
5 Controlo	5
5.1 Painel de controlo	5
5.2 Menu principal.....	5
5.2.2 Pressão	6
5.2.3 Temperatura	6
5.2.4 Download.....	7
5.2.5 Data do número de série.....	7
5.2.6.1 Idioma	7
5.2.6.2 Data/Tempo	7
5.2.6.3 User menu.....	8
5.2.6.4 Parâmetro.....	8
5.3 Alarmes/avisos.....	10
5.4 Menu Rápido	11
6 Manutenção	12
6.1 Advertências gerais.....	12
6.2 Refrigerante	12
6.3 Programa de manutenção preventiva	12
6.4 Desmontagem	13
7 Localização de avarias	14
8 Anexo	

1 Segurança

1.1 Importância do manual

- Conservar durante toda a vida útil da máquina.
- Ler o manual antes de qualquer operação.
- Está sujeito a modificações: para obter informações actualizadas, consultar a versão fornecida com a máquina.

1.2 Sinais de aviso



Instruções para evitar perigos para as pessoas.



Instruções a seguir para evitar danos no aparelho.





É necessária a presença de um técnico qualificado e autorizado.





Estão presentes símbolos cujo significado é explicado no parágrafo 8.1

1.3 Indicações de segurança

 Desligue sempre a máquina da rede eléctrica durante as operações de manutenção. Usar sempre este dispositivo para eliminar os perigos durante a manutenção.

 O manual dirige-se ao utilizador final apenas para operações que podem ser efectuadas com os painéis fechados: operações que obriguem à abertura utilizando ferramentas devem ser efectuadas por pessoal especializado e qualificado.

 Não ultrapasse os limites de projecto indicados na placa de dados

  Cabe ao utilizador evitar cargas distintas da pressão estática interna. Se houver o risco de acções sísmicas, a unidade deve ser devidamente protegida.

 Os dispositivos de segurança no circuito de ar comprimido estão a cargo do utilizador.

 O dimensionamento dos dispositivos de segurança do circuito do ar comprimido realiza-se tendo em conta as características técnicas do sistema e da legislação local em vigor.

Only use the unit for professional work and for its intended purpose.

Utilizar a unidade exclusivamente para uso profissional e para o fim para o qual foi concebida.

Cabe ao utilizador analisar todos os aspectos da aplicação em que o produto é instalado, seguir todos as normas industriais de segurança aplicáveis e todas as prescrições relativas ao produto, contidas no manual de utilização e em qualquer documentação produzida e fornecida com a unidade.

A alteração ou substituição de qualquer componente por parte de pessoal não autorizado e/ou a utilização incorrecta da unidade isentam o fabricante de qualquer responsabilidade e anulam a garantia.

Declina-se qualquer responsabilidade presente e futura por danos a pessoas, objectos e na própria unidade, resultantes de negligência por parte dos operadores, do não cumprimento de todas as instruções apresentadas neste manual, da falta de aplicação das normas em vigor relativamente à segurança da instalação.

O fabricante não se responsabiliza por eventuais danos devidos a alterações e/ou modificações da embalagem.

É da responsabilidade do utilizador certificar-se de que as especificações fornecidas para a selecção da unidade ou dos seus componentes e/ou opções são exaustivas, com vista a uma utilização correcta ou razoavelmente previsível da própria unidade ou dos componentes.

 **ATENÇÃO: O fabricante reserva-se o direito de modificar as informações contidas no presente manual, sem incorrer na obrigação de avisá-las previamente.**

Para obter informações completas e actualizadas, recomenda-se ao utilizador de consultar o fabricante.

1.4 Riscos residuais:

As operações de instalação, arranque, desactivação e manutenção da máquina devem ser taxativamente executadas conforme as indicações fornecidas na documentação técnica do aparelho e de modo a não gerar nenhuma situação de risco. A tabela seguinte indica os riscos que não foi possível eliminar na fase de concepção.

Parte considerada	Risco residual	Modo	Precauções
bateria de troca de energia	pequenos cortes	contacto	evite o contacto, use luvas de protecção
grelha do ventilador e ventilador	lesões	inserção de objectos pontiagudos através da grelha enquanto o ventilador está a funcionar	não introduza objectos de nenhum tipo dentro da grelha dos ventiladores e não pouse objectos nas grelhas
interior da unidade: compressor e tubo de saída	queimaduras	contacto	evite o contacto, use luvas de protecção
interior da unidade: partes metálicas e cabos eléctricos	intoxicações, fulguração, queimaduras graves	defeito de isolamento dos cabos de alimentação a montante do quadro eléctrico da unidade, partes metálicas sob tensão	protecção eléctrica adequada da linha de alimentação; máximo cuidado ao efectuar a ligação à terra das partes metálicas
exterior da unidade: zona que circunda a unidade	intoxicações, queimaduras graves	incêndio devido a curto circuito ou sobreaquecimento da linha de alimentação a montante do quadro eléctrico da unidade	secção dos cabos e sistema de protecção da linha de alimentação eléctrica em conformidade com as normas vigentes

2 Introdução

Este manual faz referência a secadores por refrigeração projetados para remover o vapor de água do ar comprimido.

2.1 Transporte

A unidade embalada deve permanecer:

- na posição vertical;
- protegida contra os agentes atmosféricos;
- protegida contra embates.

2.2 Movimentação

Utilizar um empilhador adequado ao peso a elevar, evitando qualquer tipo de embates.

2.3 Inspeção

- Antes de saírem da fábrica, todas as unidades são montadas, cabladas, carregadas com refrigerante e óleo e testadas nas condições de trabalho padrão;
- após receber a máquina, verificar o respectivo estado: comunicar imediatamente à empresa de transporte eventuais danos;
- desembalar a unidade o mais perto possível do local de instalação.

2.4 Armazenamento

Se for necessário colocar unidades em cima umas das outras, obedecer às notas indicadas na embalagem. Manter a unidade embalada num local limpo e protegido da humidade e intempéries.

3 Instalação

☞ Instale dentro de casa em uma área limpa e seca que seja protegida das intempéries, luz solar direta e / ou outras condições adversas.

⚠ O produto instalado deve ser adequadamente protegido contra risco de incêndio (ref. EN378-3).

3.1 Modo

⚠ Make sure to screw down the stud bolts in the flanges before connecting the counterflanges (see par. 8.6 appendix).

☞ Respeite as indicações fornecidas nos parágrafos 8.2 e 8.3.

Todos os secadores devem ser equipados com um adequado sistema de pré-filtragem próximo da entrada de ar. O vendedor não será obrigado a compensar ou reembolsar o cliente por qualquer problema

causado, directa ou indirectamente, pela ausência de pré-filtragem. ☞ O elemento pré-filtrante (para uma filtragem até 3 micrones ou inferior) deve ser substituído pelo menos uma vez por ano ou no intervalo indicado pelo fabricante.

☞ Ligar correctamente o secador às uniões de entrada/saída de ar comprimido.

3.2 Espaço operativo

☞ Deixar um espaço de 1,5 metros em volta da unidade. Deixar 2 metros de espaço sobre o secador nos modelos de expulsão vertical do ar de condensação.

3.3 Versão condensador

Versão a ar (Ac)

Não criar situações de recirculação de ar na zona de refrigeração.

Não obstruir as grelhas de ventilação.

Versão a água(Wc)

Se não for fornecido, instale um filtro da instalação na entrada de água de condensação.

☞ ☞ Características da água de condensação de entrada:

Temperatura	≥50°F (10°C)	CL ⁻	<50 ppm
ΔT IN/OUT	5-15°C	CaCO ₃	70-150 ppm
Max % de glicol	50	O ₂	<0.1 ppm
Pressão	43.5-145 PSig (3-10 barg)	Fe	<0.2 ppm
PH	7.5-9	NO ₃	<2 ppm
Condutividade eléctrica	10-500 μS/cm	HCO ₃ ⁻	70-300 ppm
Índice de saturação de Langelier	0-1	H ₂ S	<0.05 ppm
SO ₄ ²⁻	<50 ppm	CO ₂	<5 ppm
NH ₃	<1 ppm	Al	<0.2 ppm

Para águas de refrigeração especiais (desionizada, desmineralizada, destilada), os materiais padrão previstos para o condensador podem não ser adequados. Nesse caso, queira contactar o fabricante.

3.4 Sugestões

Para não danificar os componentes internos do secador e do compressor de ar, evitar as instalações em que o ar do ambiente em volta contém contaminantes sólidos e/ou gasosos: atenção, assim, a enxofre, amoníaco, cloro e instalações em ambientes marítimos. Para as versões com ventiladores axiais é desaconselhada a canalização do ar extraído.

3.5 Ligação eléctrica

Use approved cable in conformity with the local laws and regulations (for minimum cable section, see par. 8.3).

Install a differential thermal magnetic circuit breaker with contact opening distance 3 mm ahead of the system (RCCB - IDn = 0.3A) (see the relevant current local regulations).

The nominal current In of the magnetic circuit breaker must be equal to the FLA with an intervention curve type D.

Selecione a fonte de alimentação e insira uma ponte conforme mostrado abaixo:

S7-S6 para 400/3/50

S8-S6 para 460/3/60

Dentro do painel elétrico existe uma etiqueta de instruções.

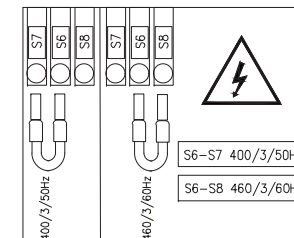

3.6 Ligação da descarga de condensação

☞ Efectuar a ligação ao sistema de descarga, evitando a ligação no circuito fechado juntamente com outras linhas de descarga pressurizadas. Verificar o correcto defluxo das descargas de condensação. Eliminar toda a condensação em conformidade com as normas ambientais locais em vigor.

4 Colocação em funcionamento

4.1 Verificações preliminares

Antes de colocar o secador em funcionamento, certifique-se de que:

- a instalação foi realizada de acordo com as instruções fornecidas na secção 3;
- as válvulas de entrada de ar estão fechadas e de que não está presente qualquer fluxo de ar através do secador;
- a alimentação elétrica é adequada;
- na versão Wc, abra o circuito da água de refrigeração alguns minutos antes de ligar o secador.



4.2 Arranque

1. Ligue a alimentação rodando o INTERRUPTOR

PRINCIPAL "  " para "I ON": o secador é ligado e a palavra "OFF" aparece no display.

 **A RESISTENCIA DO CARTER DEVE SER LIGADO 12 HORAS ANTES DE LIGAR O SECADOR.**

Em seguida, toque para entrar no painel de controle.

2. Toque em  para iniciar, o botão muda a cor de cinzento para verde, para assinalar que o secador está agora em funcionamento .

3. Ligue o secador antes do compressor de ar;
O incumprimento desta regra pode causar danos graves no compressor.

 Ventoinhas (Versão Ac): se forem ligadas com a sequência de fases errada, rodam na direção oposta, com o risco de serem danificadas (neste caso, o ar sai do armário do secador pelas grelhas do condensador em vez de sair pela grelha da ventoinha - ver o par. 8.6 e 8.7 para o fluxo de ar correto); inverta imediatamente duas fases.

4. Aguarde 5 minutos e, depois, abra lentamente a válvula de entrada de ar;
5. abra lentamente a válvula de saída de ar: o secador está agora a secar.

Monitor de fases



Se aparecer para apresentar o alarme "Monitor de fases", durante o arranque do secador, o utilizador deve verificar as ligações dos terminais de entrada do seccionador do secador.

4.3 Funcionamento

- Deixe o secador ligado durante todo o período em que o compressor de ar estiver a trabalhar;
- O secador opera no modo automático, pelo que não são necessárias quaisquer configurações;
- Na eventualidade de existirem fluxos de ar excessivos inesperados, desvie-os para evitar sobrecarregar o secador.
- Evite as flutuações da temperatura de entrada do ar.

4.4 Paragem

1. Desligue o secador 2 minutos depois de o compressor de ar parar ou, em todo o caso, após a interrupção do fluxo de ar;
2. certifique-se de que o ar comprimido não entra no secador quando ele está desconectado ou no caso de ocorrer um alarme.

3. Prima  para desligar o secador. O botão muda de cor para cinzento .
4. Rode o INTERRUPTOR PRINCIPAL "  " para "O OFF" para desligar a alimentação.

 Versão Wc, feche o circuito de água com o secador parado.

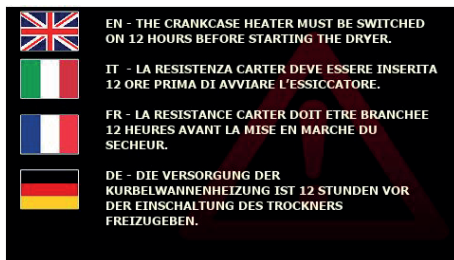

5 Controlo

5.1 Painel de controlo

25/giu/2021 - 11:04:39

LOCAL

FS 0% HGBV 0% ECO 0%

0.0 °C PDP

MANUAL DRAIN

Botões de toque	Função
	Secador OFF (cinzento)
	Secador ON (verde)

LOCAL = Configuração local
REMOTE = configuração remota

Função	Botões de toque	Função
<p>FS 48 %</p> <p>Índice de operação da ventoinha (apenas para a versão de condensador de ar)</p>		Acesso ao menu de informações: estado da máquina, pressões, temperaturas, definições gerais, consumo, password do utilizador
<p>HGBV 14 %</p> <p>Índice de operação da válvula de gás quente</p>		Cinzento = nenhum alarme Vermelho = aviso Vermelho Intermitente = alarme
<p>ECO 0%</p> <p>Poupança de energia% (Ciclo)</p>		Secador OFF = luz cinzenta Cycling ativo = piscando verde Compressor ativo = luz azul
		cinzento = Descarregador de condensação OFF verde = Descarregador de condensação ON

Função	Botões de toque	Função
<p>Toque em: para drenagem manual</p> <p>8.0 °C PDP</p>		Tendência do ponto de condensação
		<p>Função</p> <p>Strep led: azul = Compressor ativo verde = Poupança de energia Vermelho = alarme</p>

5.2 Menu principal

Toque em para entrar no menu "Informações":

Quando se toca num dos "botões de toque", durante alguns segundos o contorno acende-se para confirmar que a seleção foi feita.

Isto aplica-se a cada "botão de toque" presente no painel de controlo.

Touch para voltar ao painel de controlo.

OFF

Temperatures

Pressures

Status of I/O

Serial Number

USB Save data

General setting

5.2.1 Estado da máquina (I/O)

Toque em para entrar no menu "Estado da máquina".

Esta é a lista de entradas:

Um led, junto à descrição, indica se as proteções/funções/configurações estão:

ativas = luz verde
não ativas = luz cinzenta.
e.g .

OFF

Status of Input

- High pressure switch
- Low pressure switch
- Thermal protection compressor
- Thermal protection fan
- Phases sequence control
- Dryer remote control
- Condensate level 1
- Condensate level 2
- Condensate level 3

Toque em para entrar na página seguinte.

Esta é a lista de saídas:

OFF

Status of Output

- Plant status ON
- General Alarm
- Compressor ON
- Fan ON
- Liquid solenoid valve
- Condensate drain 1
- Condensate drain 2
- Condensate drain 3

Toque em para voltar ao menu anterior.

5.2.2 Pressão

Toque em  para entrar no menu “pressão” para visualizar: pressão de condensação, índice de operação da ventoinha, pressão de evaporação, índice de operação da válvula de gás quente

Toque em um parâmetro específico para visualizar sua tendência de dados de desempenho ao longo do tempo.

“Pressão de condensação/evaporação”

utilize  e  para percorrer o gráfico.

Toque em  para voltar ao menu anterior.

“Índice de operação da ventoinha/válvula de gás quente”

utilize  e  para percorrer o gráfico.

Toque em  para voltar ao menu anterior.

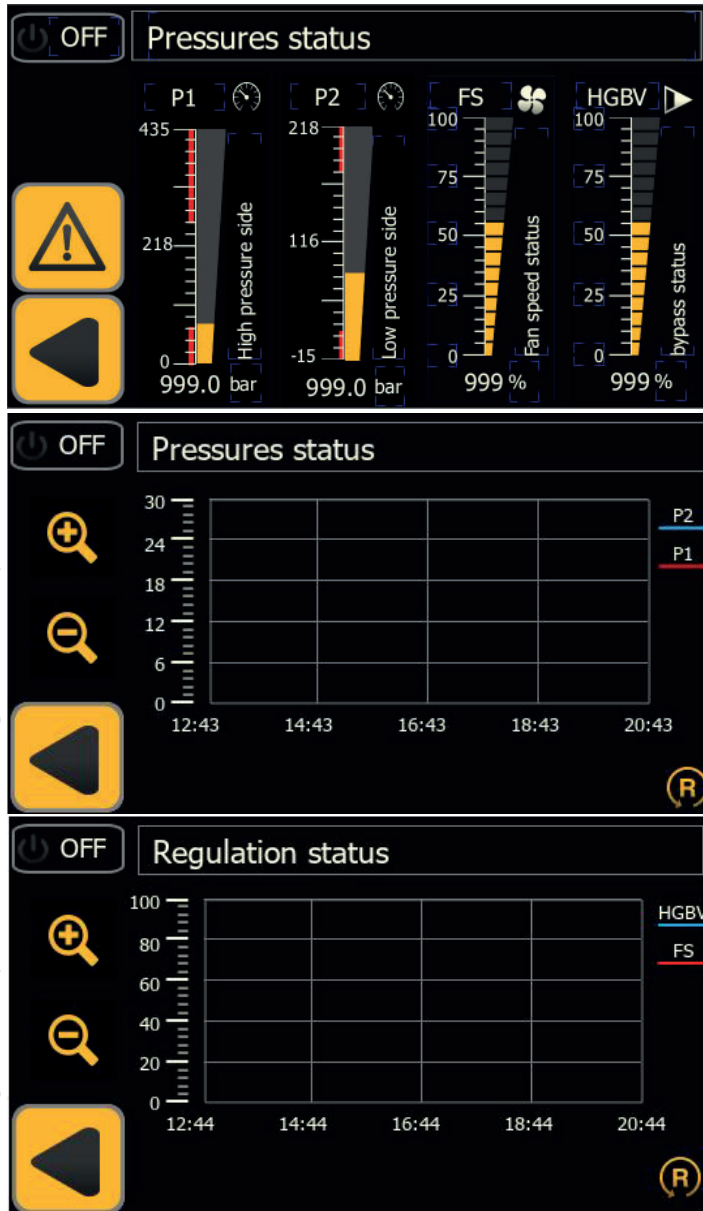

5.2.3 Temperatura

Toque em  para visualizar as leituras de temperatura pelas sondas de temperatura do diagrama do circuito.



Toque em  para entrar na página seguinte.

B4 = ativo apenas para a multicooler versão.

Toque em um dos valores de temperatura de baixa pressão para ver uma tendência de dados de todas as sondas no circuito de baixa pressão.



Toque em um dos valores de temperatura de alta pressão para ver uma tendência de dados de todas as sondas no circuito de alta pressão.

Temperatura - Lado de baixa pressão

utilize  e  para percorrer o gráfico.

Toque em  para voltar ao menu anterior.

Temperatura - Lado de alta pressão

utilize  e  para percorrer o gráfico.

Toque em  para voltar ao menu anterior.

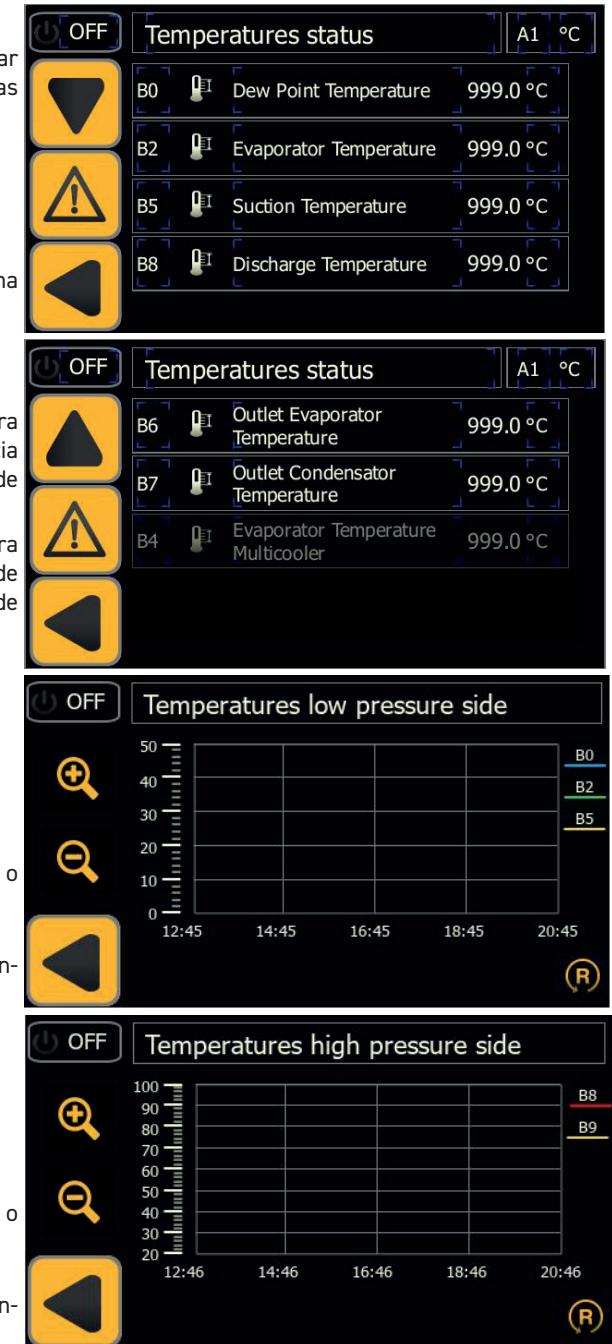

5.2.4 Download

Use um USB com led, que mostra a fase de download.
(8gB formatado como FAT32) insira no painel frontal.

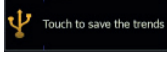
Toque em  para iniciar o download..

O tempo de download de dados depende da quantidade de dados armazenados.

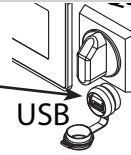

5.2.5 Data do número de série

Toque em  para entrar no menu "serial number".

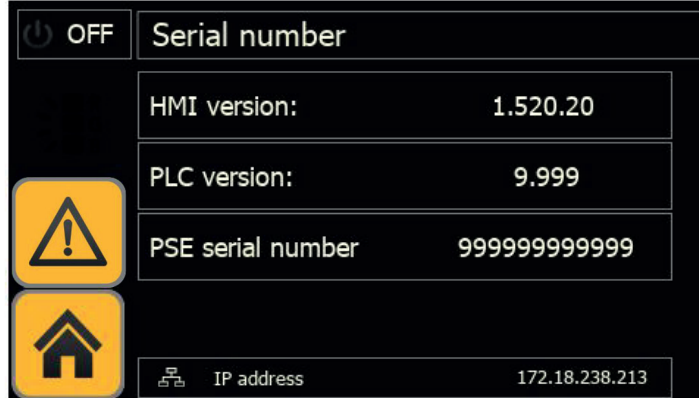

Toque em  para voltar ao painel de controle.

5.2.6 Geral

Toque em  para entrar no menu "geral" com a secção seguinte: idioma; data/hora; parâmetro; manutenção; funcionamento por ciclos/contínuo.

toque em qualquer menu para visualizar / ajustar.

Toque em  para voltar ao painel de controle.



5.2.6.1 Idioma

Toque em  para entrar no menu Idioma.
Toque no idioma que precisa.
Voltará automaticamente ao menu principal com o idioma escolhido.

Toque em  para voltar ao menu anterior.

Toque no idioma que precisa.
Voltará automaticamente ao menu principal com o idioma escolhido.

Toque em  para voltar ao menu anterior.



5.2.6.2 Data/Tempo

Toque em  para entrar no menu "Data/Tempo".
Toque Data/Tempo para proceder à mudança.

Pressione por 2 segundo

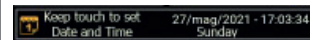

para confirmar.

Toque em  para voltar ao menu anterior.

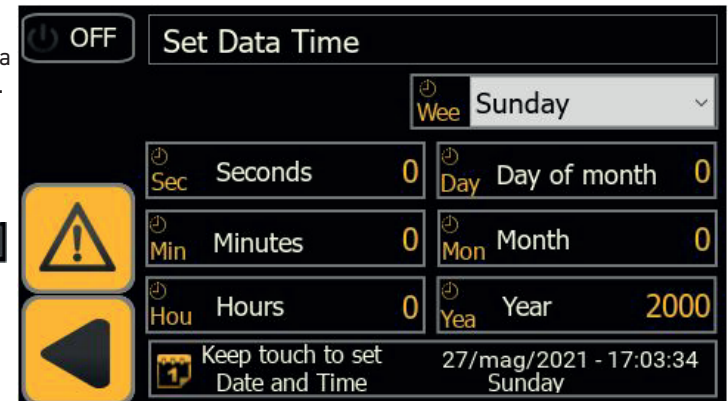

5.2.6.3 User menu

Toque em  Users access para entrar no menu "User" menu.

Este menu é reservado ao técnico de serviço Parker.

User name:

Password:

Show password

5.2.6.4 Parâmetro

Toque em  Parameters para entrar no menu "Parâmetro" com as secções seguintes: sondas, descarregador de condensação, configuração, manutenção, ciclos.

toque no "botão de toque" para entrar no menu.

Toque em  para voltar ao menu anterior.



Sondas

Toque em  Probes para definir os avisos e atrasos ou o mínimo/máximo do ponto de condensação.

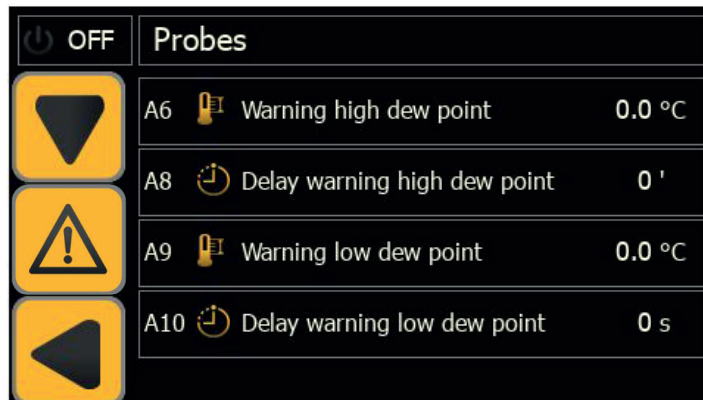

Item	Setting	Value
A6	Warning high dew point	0.0 °C
A8	Delay warning high dew point	0'
A9	Warning low dew point	0.0 °C
A10	Delay warning low dew point	0 s

Descarregador de condensação

Toque em  para entrar no menu "Descarregador de condensação" escolher:

1. descarga temporizada (escolhendo as horas de fecho e de abertura);
2. descarga capacitiva;
3. descarga contínua (descarga externa).

Toque em  para voltar ao menu anterior.



Condensate drain

D3 Modality Continuos

Configuração

Toque em  para entrar no display de configuração com o menu seguinte:

1. escolha do grau de temperatura °C / °F;
2. ativação do controlo remoto;
3. ativação apenas dos alarmes ou dos alarmes/avisos;
4. reset das definições com os parâmetros por defeito.

utilize o "botão de toque" junto à descrição para fazer a sua escolha.

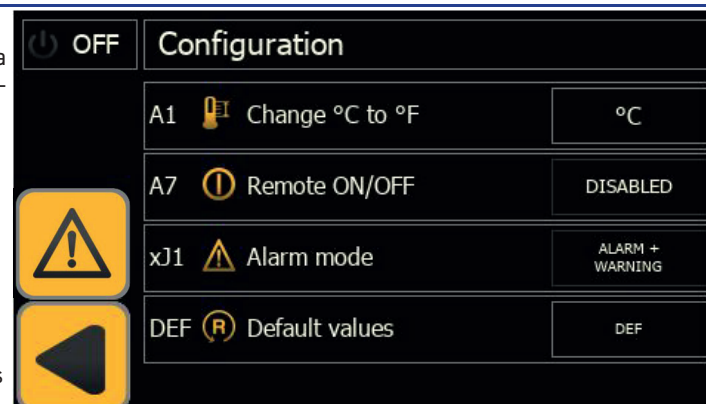

Configuration

A1 Change °C to °F °C

A7 Remote ON/OFF DISABLED

xJ1 Alarm mode ALARM + WARNING

DEF Default values DEF

 Para gerenciar o modo REMOTE OFF, remova a ponte entre os terminais: 87-92 e conecte o interruptor remoto liga / desliga (a ser fornecido pelo cliente).

Manutenção

Toque em  para ver as horas de trabalho do compressor/secador.

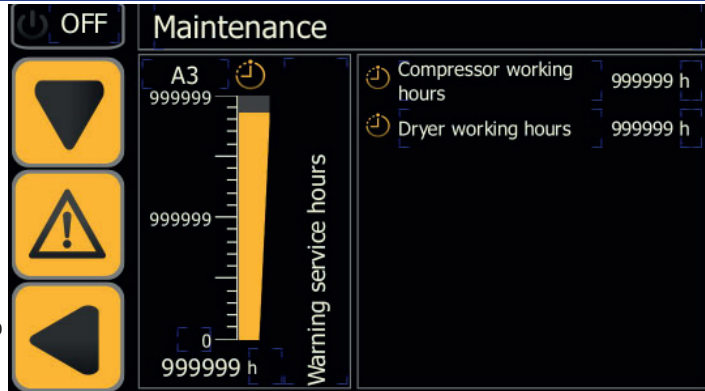

The Maintenance screen shows a power button (OFF), a dropdown arrow, a warning icon, and a left arrow. The main display shows 'A3' and '999999' next to a vertical bar chart labeled 'Warning service hours'. On the right, there are two rows: 'Compressor working hours' and 'Dryer working hours', both set to '999999 h'.

Toque em  para voltar ao menu anterior.

Funcionamento

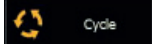
Toque em  para escolher o tipo de funcionamento: contínuo; por ciclos (poupança de energia). contínuos; cycling (energy saving). utilize o “botão de toque” junto à descrição para fazer a sua escolha.

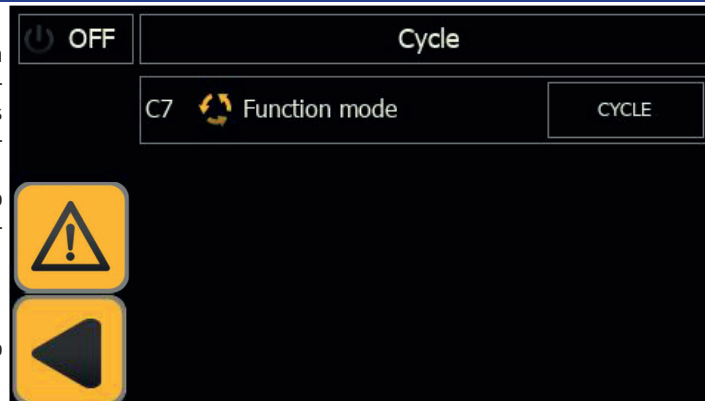

The Cycle screen shows a power button (OFF), a dropdown arrow, a warning icon, and a left arrow. The main display shows 'C7' and 'Function mode' with a 'CYCLE' button next to it.

Toque em  para voltar ao menu anterior.

Modbus

Toque em  para definir os parâmetros do Modbus. MODBUS RTU (RS485)

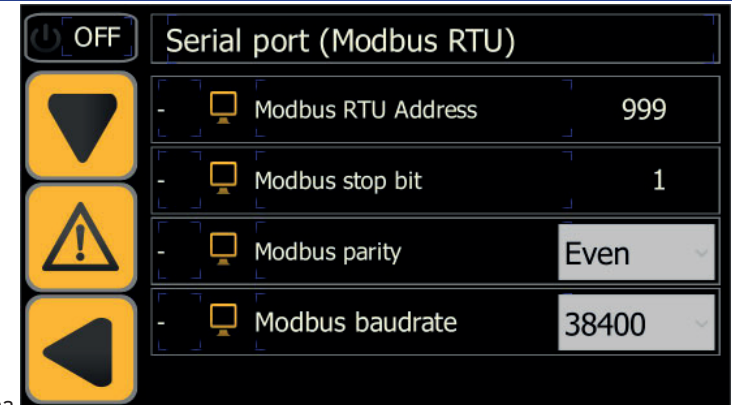

The Serial port (Modbus RTU) screen shows a power button (OFF), a dropdown arrow, a warning icon, and a left arrow. The main display shows four rows of settings: 'Modbus RTU Address' (999), 'Modbus stop bit' (1), 'Modbus parity' (Even), and 'Modbus baudrate' (38400).

Toque em  para entrar na página seguinte. MODBUS TCP/IP

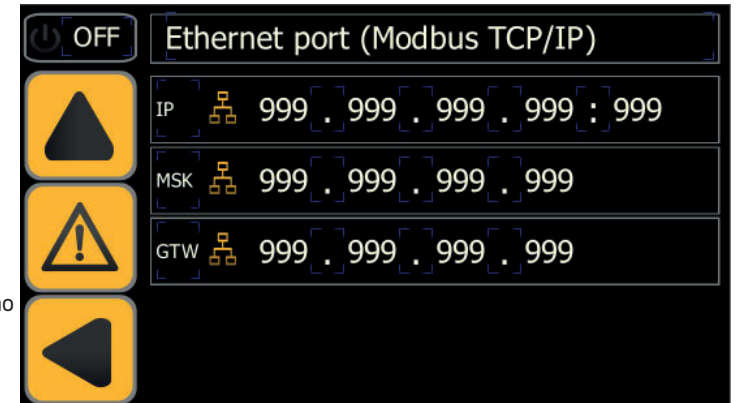

The Ethernet port (Modbus TCP/IP) screen shows a power button (OFF), a dropdown arrow, a warning icon, and a left arrow. The main display shows three rows of settings: 'IP' (999 . 999 . 999 . 999 : 999), 'MSK' (999 . 999 . 999 . 999), and 'GTW' (999 . 999 . 999 . 999).

Toque em  para voltar ao menu anterior.

Desligue/ligue a secadora para confirmar a configuração.

Cloud

Toque em  para ver a “password” para ao cloud

Esta opção está em andamento.

Toque em  para voltar ao menu anterior



The Cloud Licence screen shows a power button (OFF), a dropdown arrow, a warning icon, and a left arrow. The main display shows a password field with a cloud icon and the value '99999'.

5.3 Alarmes/avisos

Toque em  para entrar no menu “Alarmes/avisos”:

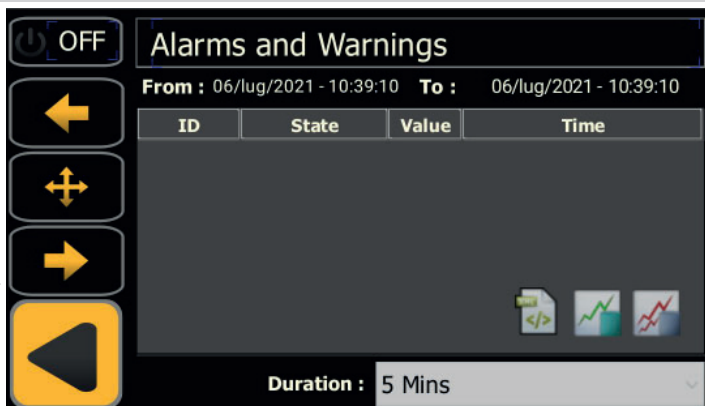

Toque em “duration” para alterar o horário da pesquisa.

Quando as condições de trabalho nominal tiverem sido restauradas, alguns avisos e alarmes são automaticamente repostos a zeros; para outros alarmes/avisos é necessário fazer um reset manual.

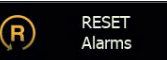
Toque em  para fazer o reset do alarme;

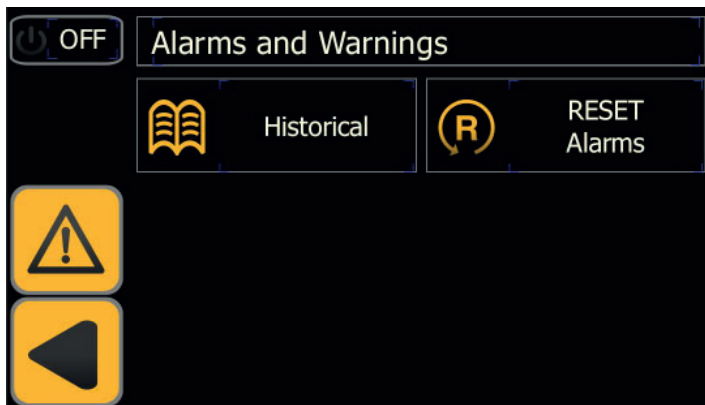

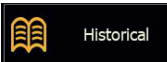
Toque em  para visualizar o histórico dos alarmes com:

o código do alarme, a data, o número de alarmes, a posição na sequência da ocorrência, e a hora de ativação do alarme.

Toque em  para voltar ao menu anterior.

5.3.1 Lista de alarmes/avisos

a = alarme; w = aviso.

Code	Alarme/aviso	Cause
aLD	Alarme Baixo Ponto de Condensação.	temperatura B0<A9 por mais que A10 segundos.
aLT	Alarme Baixa Temperatura de Evaporação.	temperatura B2<A12 por mais que A13 segundos
aHT2	Alarme de Alta Temperatura de Descarga	temperatura B8>A11
aHP	Alarme Alta Pressão.	Pressóstato de alta pressão ativo
aLP	Alarme Baixa Pressão	Pressóstato de baixa pressão ativo
aLTA	Alarme Baixa Temperatura multi-cooler	temperatura B4<A12 por mais que A13 segundos
aPI*	Alarme Térmico do Compressor	Térmico do Compressor ativo
aPH	Alarme Monitor di fase	Monitor di fase ativo (para 460-750)
aCM1	transmissão expansão 1 alarm	a expansão 1 não está se comunicando
aCM2	transmissão expansão 1 alarm	a expansão 1 não está se comunicando
wB0	Aviso Sonda B0	sonda quebrada ou não conectada
wB2	Aviso Sonda B2	sonda quebrada ou não conectada
wB4	Aviso Sonda B4	sonda quebrada ou não conectada
wB5	Aviso Sonda B5	sonda quebrada ou não conectada
wB6	Aviso Sonda B6	sonda quebrada ou não conectada
wB8	Aviso Sonda B8	sonda quebrada ou não conectada
aFP1	Alarme Transmissor de alta pressão P1	sonda quebrada ou não conectada
wHD	Aviso Alta Ponto de Condensação.	temperatura B0>A6 por mais que A8 minutos
wHT1	high discharge temperature warning	temperatura B8>A14 por mais que A15 minutos
wHP1	Aviso Alta Pressão.	pressão P1>A16 por mais que 2 segundos
wHB5	aviso de alta temperatura de sucção	temperatura B5>A18 por mais que 1 minuto
wLP2	Aviso Baixa Pressão	pressão P2<A21 por mais que 150 segundos
wSR	Aviso Manutenção Programada.	o tempo de serviço já passou
wDR1	Aviso Descarregador de condensação 1	o condensado não é descarregado de cooler 1
wDR2	Aviso Descarregador de condensação 2	o condensado não é descarregado de cooler 2
wDR3	Aviso Descarregador de condensação 3	o condensado não é descarregado de cooler 3
aFP2	Alarme Transmissor de Baixa pressão P2	sonda quebrada ou não conectada

* para os modelos de 900-1800 o alarme também pode ter o significado de fases invertidas.

5.4 Menu Rápido

Para chegar ao menu em breves passos:

Ver a temperatura

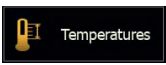
Toque em  → Toque em  Toque na pressão para ver os gráficos.

Ver a pressão

Toque em  → Toque em  Toque na pressão para ver os gráficos.

Download

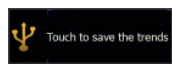
Toque em  → Toque em  para fazer o download.

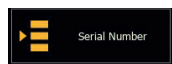

Data do número de série

Toque em  → Toque em .

Mudar o idioma

Toque em  → Toque em  → Toque em  para escolher o seu idioma.

Data/Tempo

Toque em  → Toque em  → Toque em  para atualizar o relógio.

Mudança da unidade de medição de °C para °F, Remote, DEF

Toque em  → Toque em  → Toque em  → Toque em 

Toque no parâmetro “°C” ou “°F” para fazer a alteração.

Habilite/desabilite o parâmetro “ON/OFF remoto”.

Toque em “DEF” para restaurar o parâmetro.

Passar para o funcionamento por “ciclos”

Toque em  → Toque em  → Toque em  → Toque em 

para mudar o funcionamento.

Descarregador

Toque em  → Toque em  → Toque em  → Toque em 

para escolher o seu descarregador.

Modbus



Toque em  → Toque em  → Toque em  → Toque em 

Configuração de parâmetros

Toque em  → Toque em  → Toque em  → Toque em 

para mudar o parâmetro.

Alarme/aviso

Toque em  → Toque em  para encontrar alarme histórico e redefinir alarme.

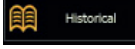
Toque em  para encontrar alarme histórico

Toque em  para redefinir alarme

6 Manutenção

- A máquina foi concebida e fabricada de modo a garantir um funcionamento contínuo; no entanto, o período de vida útil dos componentes depende do tipo de manutenção efectuada.
-  Ao solicitar assistência técnica ou a substituição de componentes, identifique a máquina (modelo e número de série) lendo a placa de características localizada na unidade.
- Os circuitos com 5t < xx < 50t de CO₂ devem ser verificados, pelo menos, uma vez por ano para identificar eventuais fugas.
 - Os circuitos com 50t < xx < 500t de CO₂ devem ser verificados, pelo menos, uma vez a cada seis meses para identificar eventuais fugas. ((UE) N° 517/2014 art. 4.3.a, 4.3.b).
- No caso de máquinas com 5t CO₂ ou mais, o operador deve manter um registo a declarar a quantidade e o tipo de refrigerante utilizado, as quantidades eventualmente adicionadas e as quantidades recuperadas durante as operações de manutenção, reparação e eliminação final ((UE) N° 517/2014 art. 6.).

6.1 Advertências gerais

- ⚠ Antes de qualquer manutenção, verificar se:
 - o circuito pneumático já não está sob pressão;
 - o secador está desligado da rede eléctrica.

 Utilizar sempre peças de substituição originais do fabricante: caso contrário, o fabricante não se responsabiliza por qualquer avaria da máquina.

 Em caso de perda de refrigerante, contactar pessoal qualificado e autorizado.

 A válvula Schrader deve ser utilizada apenas em caso de um funcionamento incorrecto da máquina: caso contrário, os danos provocados por um carregamento errado do refrigerante não serão reconhecidos na garantia.

6.2 Refrigerante

Operação de carregamento: eventuais danos provocados por um carregamento de refrigerante errado realizado por pessoal não autorizado não serão reconhecidos pela garantia. 















 O aparelho contém gases fluorados com efeito de estufa.

O líquido refrigerante R513A à temperatura e pressão normal é um gás incolor pertencente ao SAFETY GROUP A1 - EN378 (líquido de grupo 2 segundo a directiva PED 2014/68/UE); GWP (Global Warming Potential) = 573.

⚠ Em caso de fuga de refrigerante, arejar o local.

6.3 Programa de manutenção preventiva

Para garantir a máxima eficiência e fiabilidade do secador ao longo do tempo, proceder do seguinte modo:

Maintenance Activity Description	Maintenance Interval (standard operating conditions)				
	Daily	Weekly	4 Months	12 Months	36 Months
Activity					
Check  Service 					
Verifique se a luz avisadora POWER ON está acesa.					
Verifique os indicadores do painel de controlo.					
Limpe o filtro da válvula pressostática de água, se não estiver sujo, aumente o intervalo de inspeção (ver instruções) (PSE750-1800)					
Verifique o descarregador de condensação.					
Limpe as aletas do condensador.					
Verifique a posição e operação corretas do resistência cárter.					
Verifique o consumo eléctrico.					
Die Anlage auf Kältemittelverluste kontrollieren.					
Despressurize o sistema. Effectue a manutenção do descarregador.					
Despressurize o sistema. Substitua os elementos do pré-filtro e do pós-filtro.					
Verifique as sondas das temperaturas. Substitua-as se necessário.				 	
Kit de manutenção do secador.					



Estão disponíveis (consultar o parágrafo 8.4):

- kit de manutenção preventiva de 3 anos;
- kit de serviço:
 - kit do compressor;
 - kit do ventilador;
 - kits da válvula de gás quente;
 - kits do condensador de água;
- peças de substituição individuais.

6.4 Desmontagem

O líquido refrigerante e o óleo lubrificante que existe no circuito devem ser recuperados em conformidade com as normas ambientais locais em vigor.

A recuperação do líquido refrigerante deve ter lugar antes da eliminação final do equipamento ((UE) N° 517/2014 art. 8.).

	Reciclagem Eliminação 
carpintaria	aço/resinas de epóxi-poliéster
permutador	alumínio
tubagens/colectores	cobre/alumínio/aço de carbono
descarregador	polyamide
isolamento do permutador	EPS (poliestireno sintético)
isolamento das tubagens	borracha sintética
compressor	aço/cobre/alumínio/óleo
condensador	cobre/alumínio
refrigerante	R513A
válvulas	latão
cabos eléctricos	cobre/PVC

Os equipamentos que contenham componentes eléctricos devem ser descartados separadamente junto com os resíduos eléctricos e eletrónicos de acordo com a legislação local e vigente.



7 Localização de avarias

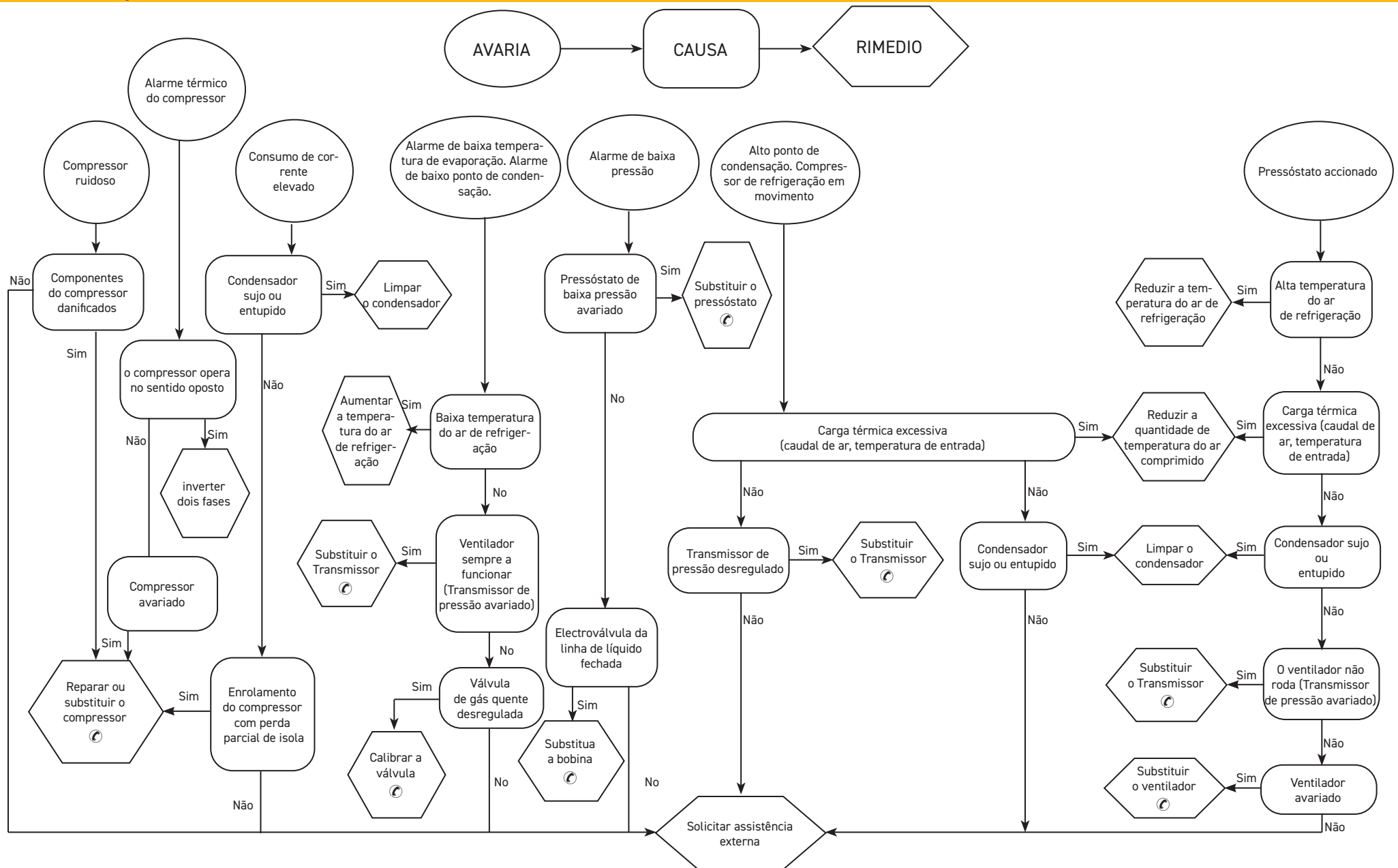

Innehållsförteckning

1 Säkerhet	1
1.1 Manualens betydelse	1
1.2 Varningsskyltar	1
1.3 Säkerhetsanvisningar	1
1.4 Kvarstående risker	2
2 Inledning	2
2.1 Transport	2
2.2 Hantering	2
2.3 Inspektion	2
2.4 Magasinering	2
3 Installation	3
3.1 Gör så här	3
3.2 Utrymme som krävs för arbetet	3
3.3 Kondensatorversion	3
3.4 Tips	3
3.5 Elektrisk anslutning	3
3.6 Anslutning av kondensavledare	3
4 Commissioning	4
4.1 Preliminary checks	4
4.2 Starting	4
4.3 Drift	4
4.4 Stopp	4
5 Reglage	5
5.1 Kontrollpanel	5
5.2 Huvudmeny	5
5.2.1 Maskinstatus (I/O)	5
5.2.2 Tryck	6
5.2.3 Temperatur	6
5.2.4 Nedladdning	7
5.2.5 Serienummer data	7
5.2.6 Allmänt	7
5.2.6.1 Språk	7
5.2.6.2 Datum/Timme	7
5.2.6.3 User meny	8
5.2.6.4 Parameters	8
5.3 Larm/Varningar	10
5.3.1 Lista över larm/varningar	10
5.4 Snabbmeny	11
6 Underhåll	12
6.1 Allmän information	12
6.2 Kylmedel	12
6.3 PProgram för förebyggande underhåll	12
6.4 Isärtagning	13
7 Felsökning	14
8 Bilaga	

1 Säkerhet

1.1 Manualens betydelse

- Spar manualen under maskinens hela livstid.
- Läs alltid manualen innan någon typ av ingrepp görs.
- Ändringar kan göras i manualen. Uppdaterad information finns i manualversionen som medföljer maskinen.

1.2 Varningsskyltar



Instruktioner för att undvika risker för människor.



Instruktioner för att undvika risker för utrustningen.











Det krävs att en teknisk fackman är närvarande.



Symboler vars betydelse förklaras i avsnittet 8.1

1.3 Säkerhetsanvisningar

-  Skilj alltid maskinen från elnätet under underhålls-ingrepp. Använd alltid denna frånskiljare för att undanröja faror innan underhåll utförs
-  Manualen riktar sig till slutanvändaren endast vad gäller de arbetsmoment som kan göras med stängda paneler. Arbeten som kräver att paneler öppnas med verktyg måste göras av fackutbildad personal.
-  Överskrid inte projektsgränserna som finns på dataskylten.
-   Det åligger användaren att undvika andra belastningar än det inre statiska trycket. Om det finns risk för sysmisk aktivitet måste enheten skyddas på lämpligt sätt.
-  Säkerhetsanordningarna på tryckluftskretsen skall tillhandahållas av användaren.
-  Utför dimensionering av säkerhetsanordning på tryckluftskretsen med hänsyn tagen till anläggningens tekniska specifikationer och till lokala lagar och förordningar. Använd maskinen uteslutande för yrkesbruk och för det bruk som den är avsedd för.
-  Det åligger användaren att analysera alla aspekter av applikationen där produkten skall installeras, att följa alla tillämpliga industristandarder om säkerhet och alla föreskrifter gällande produkten som finns i bruksanvisningen och i alla handlingar som medföljer enheten.
-  Ändringar eller byten av komponenter som utförs av personal som inte är auktoriserad för ändamålet

och/eller olämplig användning av maskinen gör garantin ogiltig.

Tillverkaren accepterar inget ansvar för personskador, skador på föremål eller på själva maskinen som orsakas av personalens försummelse, av bristande respekt för instruktionerna i denna manual, av bristande tillämpning av gällande bestämmelser om anläggningens säkerhet.

Tillverkaren accepterar inget ansvar för skador som orsakas av ändringar och/eller modifieringar av emballaget.

Det åligger användaren att se till att tillhandahållna specifikationer om val av enhet eller dess komponenter och/eller tillvalsfunktioner är tillräckligt uttömmande för att användningen av enheten och dess komponenter skall kunna ske på korrekt eller rimligen förutsägbart sätt.

 **OBS: Tillverkaren förbehåller sig rätten att ändra informationerna i denna handbok utan att på förhand underrätta om detta.**

För en komplett och uppdaterad information rekommenderas användaren att konsultera Tillverkaren.

1.4 Kvarstående risker

Installationen, starten, avstängningen, underhållet av maskinen måste utföras i överensstämmelse med vad angivet i den tekniska dokumentationen för maskinen och alltid på sådant sätt att den inte ger upphov till någon risksituation. Riskerna som inte varit möjliga att eliminera under projekteringsfasen anges i följande tabell.

påverkad del	kvarstående risk	exponeringssätt	försiktighetsåtgärd
värmeväxlingsspole	små skärsår	kontakt	undvik kontakt, använd skyddshandskar
fläktgaller och fläkt	lesioner	införande av spetsiga föremål genom gallret medan fläkten fungerar	för inte in några föremål i fläktgallren och lägg inga föremål ovanpå gallren
invändigt enheten: kompressor och tryckrör	brännskador	kontakt	undvik kontakt, använd skyddshandskar
invändigt enheten: metalldelar och elektriska kablar	förgiftningar, elektriska stötar, allvarliga brännskador	isoleringsfel på matarkablar före enhetens elpanel, metalldelar under spänning	passande elektriskt skydd på matarlinjen; yttersta omsorg när du jordar metalldelarna
utvändigt enheten: område omkring maskinen	förgiftningar, allvarliga brännskador	eldsvåda orsakad av kortslutning eller överhettning av matarlinjen före enhetens elpanel	försäkra dig om att genomskärningsytan av kablarna och skyddssystemet för den elektriska matarlinjen är i överensstämmelse med gällande normer

2 Inledning

Denna handbok hänvisar till kyltorkar som är utformade för att avlägsna vattenånga från tryckluft.

2.1 Transport

Den emballerade enheten måste:

- vara i vertikalt läge,
- skyddas mot vädrets verkan,
- skyddas mot stötar.

2.2 Hantering

Använd en gaffeltruck som är lämpad för vikten som skall lyftas. Undvik stötar.

2.3 Inspektion

- I fabriken monteras alla enheter, kablas, fylls med kylmedel och olja, provkörs under normala arbetsförhållanden;
- Kontrollera maskinens skick vid mottagandet och reklamera omgående eventuella skador till transportfirman.
- Avlägsna emballaget från enheten så nära installationsplatsen som möjligt.

2.4 Magasinering

Följ anvisningarna som finns på emballaget om flera enheter måste staplas ovanpå varandra. Förvara den emballerade enheten på en ren plats där den skyddas mot fukt och vädrets inverkan.

3 Installation

☞ Installera inomhus i ett rent, torrt område som är skyddat från väder och vind, direkt solljus och / eller andra hårda förhållanden.

⚠ Den installerade produkten måste skyddas mot brandrisk (ref. EN378-3).

3.1 Gör så här

⚠ Måste man skruva åt låsskruvarna i flänsarna ända till anslaget innan flänskopplingarna ansluts (se avsnittet 8.6).

☞ Respektera anvisningarna i avsnitten 8.2 och 8.3.

Alla torkare ska vara utrustade med ett lämpligt förfilter installerat i närheten av torkarens luftinlopp. Leverantören utesluter alla krav på ersättning eller skadestånd för eventuella direkta eller indirekta skador som uppstår till följd av underlåtenhet att installera förfilter.

☞ Förfilterelementet (för filtrering ner till 3 micron eller mindre) måste bytas minst en gång per år eller med de intervaller som anvisas av tillverkaren.

☞ Anslut torkaren på korrekt sätt till tryckluftsinloppet och tryckluftsutloppets kopplingar.

3.2 Utrymme som krävs för arbetet

☞ Lämna ett utrymme på minst 1,5 meter runt enheten.

Lämna 2 meters utrymme ovanför torkarmodeller med vertikalt utsläpp av kondensationsluften.

3.3 Kondensatorversion

Luftversion (Ac)

Se till att det inte skapas situationer där kyl luften återcirkuleras.

Täpp inte igen ventilationsgallren.

Vattenversion (Wc)

Om ett nätfilter inte medföljer, installera ett nätfilter på kondensvattenintaget.

☞  Det inkommande kondensvattnets egenskaper:

Temperatur	>50°F (10°C)	CL ⁻	<50 ppm
ΔT IN/OUT	5-15°C	CaCO ₃	70-150 ppm
Max % glykol	50	O ₂	<0.1 ppm
Tryck	43.5-145 PSig (3-10 barg)	Fe	<0.2 ppm
PH	7.5-9	NO ₃	<2 ppm
Elektrisk ledningsförmåga	10-500 μS/cm	HCO ₃ ⁻	70-300 ppm
Langeliers mättningsindex	0-1	H ₂ S	<0.05 ppm
SO ₄ ²⁻	<50 ppm	CO ₂	<5 ppm
NH ₃	<1 ppm	Al	<0.2 ppm

För särskilda kylvatten (avjoniserat, demineraliserat, destillerat) kan standardmaterialen förutsedda för kondensatorn vara olämpliga. I sådana fall ombedes du kontakta tillverkaren.

3.4 Tips

För att torkarens och luftkompressorns invändiga komponenter inte skall skadas, undvik installationer där omgivningsluften innehåller fasta och/eller gasformiga förorenande ämnen: se upp med svavel, ammoniak, klor och installationer i havsmiljö. För versioner med axialfläktar rekommenderas inte kanalisering av den förbrukade luften.

3.5 Elektrisk anslutning

Använd en kabel som är godkänd enligt lokala lagar och bestämmelser (kabelns minsta tvärsnitt specificeras i avsnittet 8.3).

Installera den magnetotermiska differentialströmbrytaren uppströms om anläggningen (RCCB - IDn = 0.3A). Differentialströmbrytaren skall 3 mm kontaktavstånd i öppet läge (se lokala bestämmelser som gäller på detta område).

Denna magnetströmbrytares nominella ström "In" måste vara lika med FLA och tillslagskurvan måste vara av typ D.

Välj strömförsörjning och sätt in en brygga enligt bilden nedan:

S7-S6 för 400/3/50

S8-S6 för 460/3/60

Inuti elpanelen finns en instruktionsetikett.

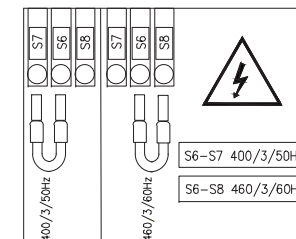

3.6 Anslutning av kondensavledare

☞ Gör anslutningen till avledningssystemet. Gör inte anslutningen i en sluten krets som är gemensam med andra trycksatta avledningssystem. Kontrollera att den tömda kondensen leds bort på korrekt sätt. Kassera all kondens i enlighet med gällande lokal miljölagstiftning.

4 Commissioning

4.1 Preliminary checks

Before commissioning the dryer, make sure:



- installation was carried out according that given in the section 3;
- the air inlet valves are closed and that there is no air flow through the dryer;
- the power supply is correct;
- with Wc version, open the cooling water circuit a few minutes before starting the dryer.

4.2 Starting

1. Slå på strömmen genom att vrida HUVUDSTRÖMBRYTAREN "  " till läget "I PÅ": torkaren strömförsörjs och ordet "OFF" visas på displayen.

 **SKYDDSHÖLJETS MOTSTÅND SKALL KOPPLAS IN 12 TIMMAR INNAN AVFUKTAREN STARTAS.**

Tryck sedan på för att gå in på kontrollpanelen.

2. Tryck på  för att starta: knappen ändrar färg från grå till grön för att visa att torkaren nu är i drift .
3. Starta torkaren före luftkompressorn.
Underlåtenhet att följa denna regel kan allvarligt skada kompressorn.

 Fläktar (Ac-version): Om de ansluts med fel fasföljd roterar de i motsatt riktning med risk att skadas (i detta fall lämnar luften torkskåpet genom kondensorgallren i stället för fläktgallret - se avsnitt 8.6 och 8.7 för korrekt luftflöde). Växla omedelbart två faser.

4. Vänta 5 minuter och öppna sakta luftinloppsventilen.
5. Öppna sakta luftutloppsventilen: nu torkar torkaren..

Fasmonitor



Om displayen visar ett larm när torkaren startas upp måste användaren verifiera ledningsdragningen av ingångsterminalerna i torkarens fränkopplingsbrytare.

4.3 Drift

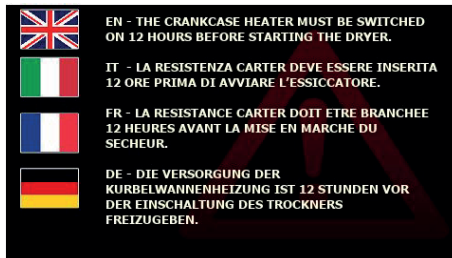
- Låt torkaren vara på hela tiden när luftkompressorn arbetar.
- Torkaren arbetar i automatiskt läge och därför krävs inga fältinställningar.
- I händelse av oförutsedda stora luftflöden, använd bypass för att inte överbelasta torkaren.
- Undvik fluktuationer i den ingående lufttemperaturen.



4.4 Stopp

1. Stoppa torkaren 2 minuter efter att luftkompressorn har stoppat, eller i varje fall efter ett avbrott i luftflödet.
2. Se till att tryckluft inte tränger in i torkaren när torkaren fränkopplas eller om ett larm inträffar.
3. Tryck på  för att stänga av torkaren. Knappen ändrar färg till grå .
4. Vrid HUVUDSTRÖMBRYTAREN "  " ill läget "0 AV" för att stänga av strömmen.

 Wc-version: stäng vattenkretsen när torkaren har stannat.

5 Reglage

5.1 Kontrollpanel

25/giu/2021 - 11:04:39

LOCAL

FS 0 %
HGBV 0 %
ECO 0 %

0.0 °C
PDP

MANUAL DRAIN

Tryckknappar	Funktion
	Torkaren AV (grå)
	Torkaren PÅ (grön)

LOCAL = Lokal konfiguration
REMOTE = Fjärr konfiguration

Funktion
FS 48 % Fläktdrift (endast för version av luftkondensator)
HGBV 14 % Drift av varmgasventil
ECO 0 % Energibesparing% (Cykel)

Funktion
8.0 °C Daggpunkts-trend

Tryckknappar	Funktion
	Åtkomst till informationsmeny: maskinstatus, tryck, temperaturer, allmänna inställningar, förbrukning, användarlösenord.
	Grå = ingen larm Röd = varningar Röd blinkande = larm.
	Torkaren AV = grått ljus Cykling aktiv = blinkar grönt Kompressor aktiv = ljusblå
	grå = Kondensatdränering OFF grön = Kondensatdränering ON

Tryckknappar	Funktion
MANUAL DRAIN	Tryck på: för manuell dränering

Funktion	
	Strep led: ljusblå = Compressor active
	grön = Energibesparing
	Röd = larm

5.2 Huvudmeny

Tryck på för att ta fram menyn "Information":
När en av "tryckknapparna" trycks in tänds knappens kontur några sekunder för att visa att det valet har gjorts.
Detta gäller alla "tryckknappar" på kontrollpanelen.
Tryck på för att återgå till Kontrollpanel.

OFF

Temperatures

Pressures

Status of I/O

Serial Number

USB Save data

General setting

5.2.1 Maskinstatus (I/O)

Tryck på för att ta fram menyn "Maskinstatus":
Detta är listan över ingångar: En LED (lysdiod), stäng beskrivningen, indikerar om skydden / funktionerna / konfigurationerna är:
aktiva = grönt ljus
inaktiva = grått ljus
Tryck på för att ta fram nästa sida.
Detta är listan över utgångar:

OFF

Status of Input

- High pressure switch
- Low pressure switch
- Thermal protection compressor
- Thermal protection fan
- Phases sequence control
- Dryer remote control
- Condensate level 1
- Condensate level 2
- Condensate level 3

OFF

Status of Output

- Plant status ON
- General Alarm
- Compressor ON
- Fan ON
- Liquid solenoid valve
- Condensate drain 1
- Condensate drain 2
- Condensate drain 3



Tryck på för att återgå till föregående meny.

5.2.2 Tryck

Tryck på  för att ta fram menyn "Tryck" för att visa: kondenseringsstryck, fläktdrift, förångningstryck, drift av varmgasventil.

Tryck på en specifik parameter för att se dess datatrend för över tid.

"Kondenserings/Förångningstryck"

Använd  och  för att bläddra genom diagrammet.

Tryck på  för att återgå till föregående meny.
"Drift av varmgasventil/fläkt"

Använd  och  för att bläddra genom diagrammet.

Tryck på  för att återgå till föregående meny.

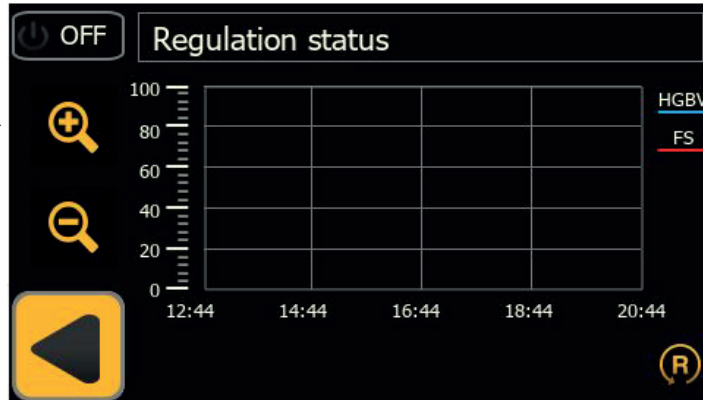
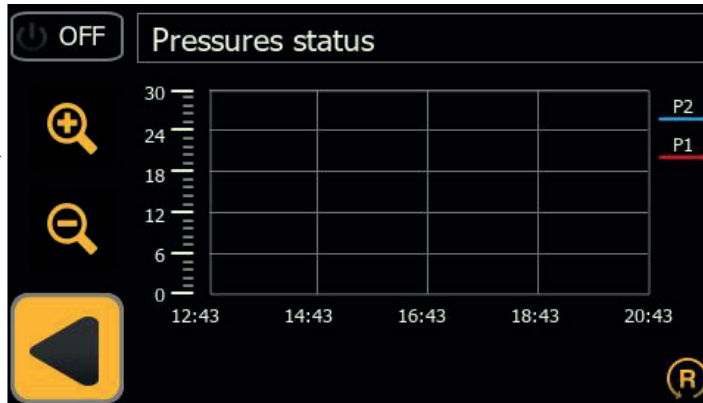
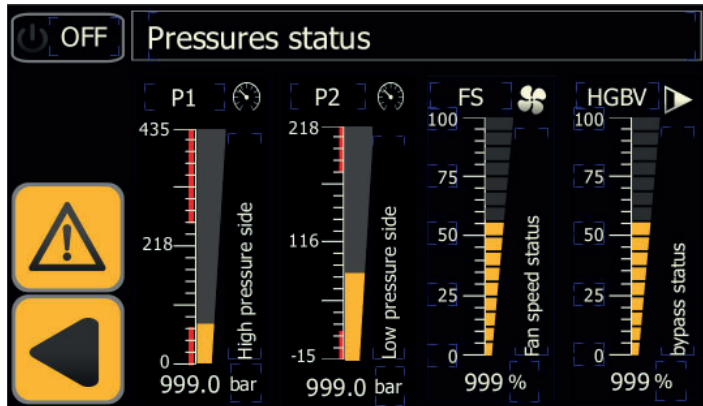

5.2.3 Temperatur

Tryck på  för att visa temperatursondernas temperaturavläsningar i kretsdiagrammet.



Tryck på  för att ta fram nästa sida.

B4 = aktiv endast för version multicooler.

Tryck på ett av lågtrycksvärdena för att se en datatrend för alla sonder i lågtryckskretsen.

Tryck på ett av högtrycksvärdena för att se en datatrend för alla sonder i högtryckskretsen.it

Temperatur - Lågtryckssida

Använd  och  för att bläddra genom diagrammet.

Tryck på  för att återgå till föregående meny.

Temperatur - högtryckssidan

Använd  och  för att bläddra genom diagrammet.

Tryck på  för att återgå till föregående meny.

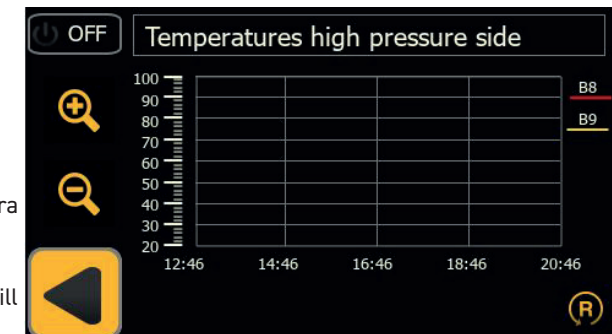
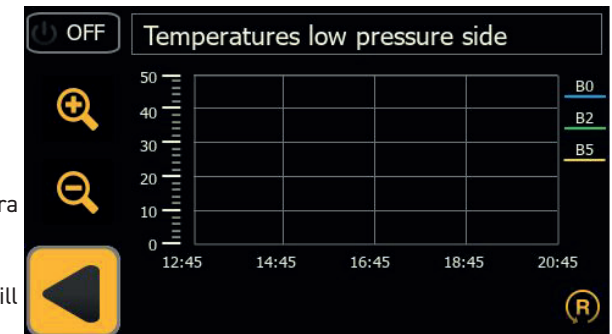
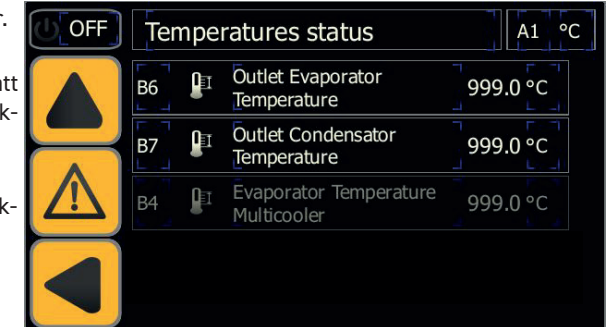
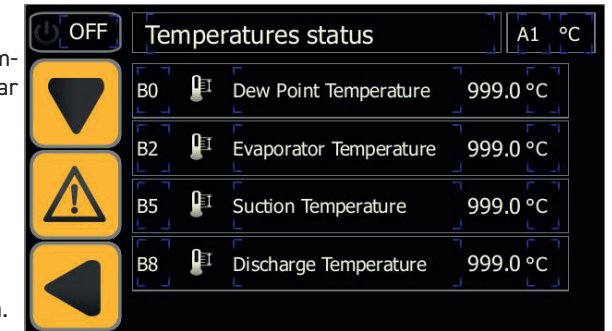

5.2.4 Nedladdning

Använd en USB med led som visar nedladdningsfasen. (8gB formaterad som FAT32) sätt in i frontpanelen.

Tryck på  för att starta nedladdningen. Tiden för dataöverföringen beror på mängden lagrad data.

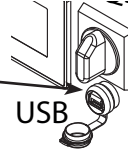

5.2.5 Serienummer data

Tryck på  för att ta fram menyn "Serial number".

OFF	Serial number
	HMI version: 1.520.20
	PLC version: 9.999
	PSE serial number 999999999999
	IP address 172.18.238.213

Tryck på  för att återgå till Kontrollpanel.

5.2.6 Allmänt

Tryck på  för att ta fram menyn "Allmänt" med följande sektioner: språk, datum/timme, parameter, underhåll, cykling/kontinuerlig drift.

Tryck på valfri meny för att visa / justera.

Tryck på  för att återgå till Kontrollpanel.

OFF	Languages Selection
	Set Data Time
	Parameters
	Users access

5.2.6.1 Språk

Touch  för att ta fram menyn "Språk". Tryck på önskat språk. Du återgår sedan automatiskt till huvudmenyn med det valda språket.

Tryck på  för att återgå till föregående meny.

Tryck på önskat språk. Du återgår sedan automatiskt till huvudmenyn med det valda språket.

Tryck på  för att återgå till föregående meny.

OFF	English	Italian	German
	Czech	Polish	Slovak

OFF	French	Spanish	Swedish
	Russian	Dutch	Portuguese

5.2.6.2 Datum/Timme

Tryck på  för att ta fram menyn "Datum/Timme":

Tryck på Datum/Timme för att fortsätta med ändringen.

Tryck i 2 sekunder

 27/mag/2021 - 17:03:34 Sunday

för att bekräfta.

Tryck på  för att återgå till föregående meny.

OFF	Set Data Time					
	Sec	Seconds	0	Day	Day of month	0
	Min	Minutes	0	Mon	Month	0
	Hou	Hours	0	Yea	Year	2000
	Keep touch to set Date and Time				27/mag/2021 - 17:03:34 Sunday	

5.2.6.3 User meny

Tryck på  Users access för att ta fram menyn "User".

Den här menyn är reserverad för Parkers servicetekniker.

User name:

Password:

Show password

5.2.6.4 Parameters

Tryck på  Parameters för att ta fram menyn "Parameter" med följande sektioner: sonder, kondensatdränning, konfiguration, underhåll, cykler.

Tryck på tryckknappen för att gå in i menyn.

Tryck på  för att återgå till föregående meny.



Sonder

Touch  Probes för att ställa in varningar och fördröjningar eller den lägsta/högsta daggpunkten.

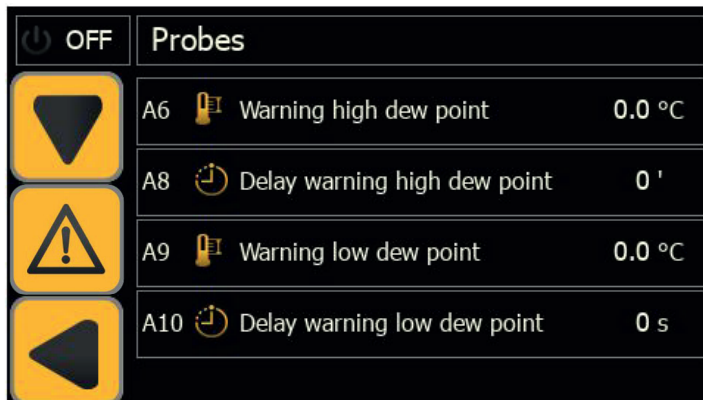

Kondensatdränning

Tryck på  Condensate drain för att ta fram menyn "Kondensatdränning".

Det går att välja:

1. Tidsinställd dränning (val av öppnings- och stängningstider),
2. Kapacitiv dränning,
3. Kontinuerlig dränning (extern dränning).

Tryck på  för att återgå till föregående meny.

Konfiguration

Tryck på  Configuration för att ta fram konfigurationsskärmen med följande meny:

4. Välja temperaturenhet, grader °C / °F,
5. Aktivera fjärrkontroll,
6. Aktivera endast larm eller larm/varningar,
7. Återställa inställningarna till standardparametrarna.

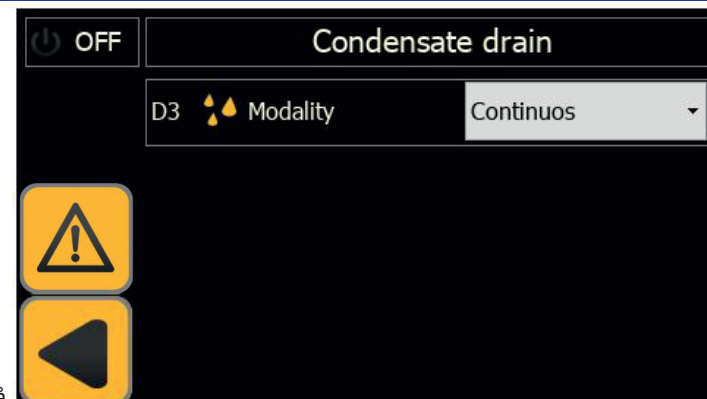

Använd tryckknappen nära beskrivningen för att göra ditt val.

 För att hantera läget FJÄRR AV, ta bort bryggan mellan terminalerna: 87-92 och anslut fjärrkontrollens start / stopp-omkopplare (ska tillhandahållas av kunden).

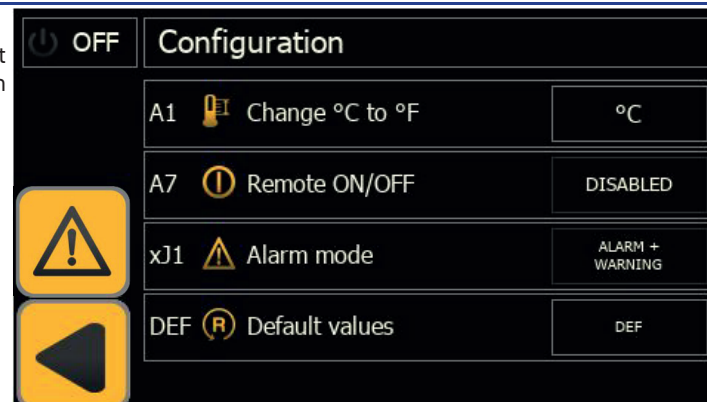

Underhåll

Tryck på  för att se driftstimmarna för kompressor/torkare.

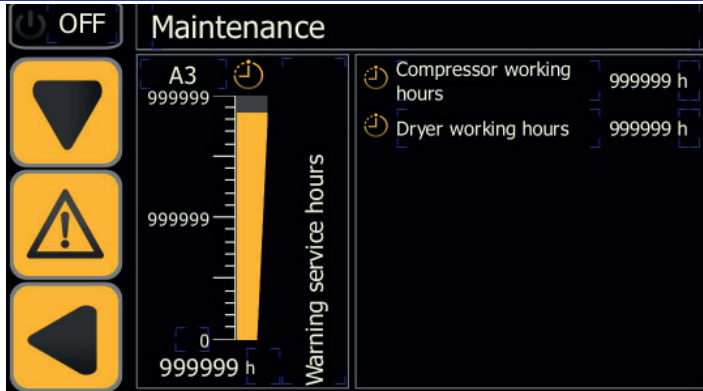

The screenshot shows the 'Maintenance' screen with a power button labeled 'OFF'. It features a vertical bar graph for 'Warming service hours' with a value of 'A3 999999'. On the right, there are two rows of data: 'Compressor working hours' and 'Dryer working hours', both showing '999999 h'. Navigation buttons (up, down, left, right, and a warning icon) are visible on the left side.

Tryck på  för att återgå till föregående meny.

Drift

Tryck på  för att välja typen av drift: kontinuerlig, cyklisk (energibesparande).

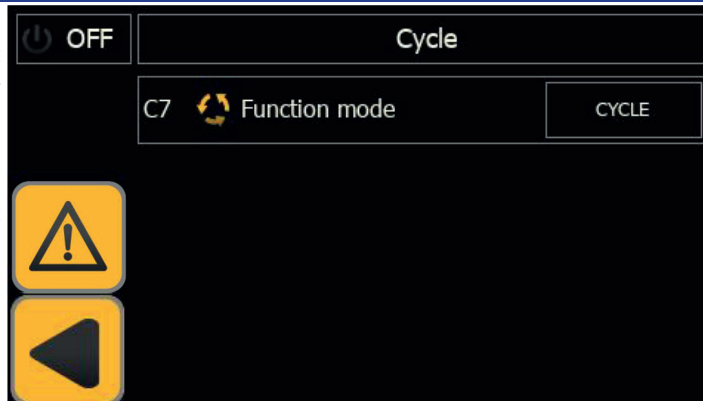

The screenshot shows the 'Cycle' screen with a power button labeled 'OFF'. It displays 'C7' and 'Function mode' with a 'CYCLE' button. Navigation buttons (up, down, left, right, and a warning icon) are visible on the left side.

Använd tryckknappen nära beskrivningen för att göra ditt val.

Tryck på  för att återgå till föregående meny.

Modbus

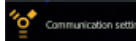
Tryck på  för att ställa in Modbus-parametrar. MODBUS RTU (RS485)

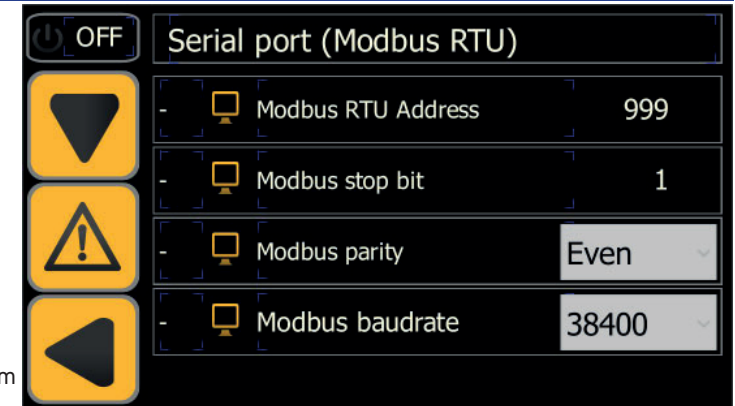

The screenshot shows the 'Serial port (Modbus RTU)' screen with a power button labeled 'OFF'. It lists four parameters: 'Modbus RTU Address' (999), 'Modbus stop bit' (1), 'Modbus parity' (Even), and 'Modbus baudrate' (38400). Navigation buttons (up, down, left, right, and a warning icon) are visible on the left side.

Tryck på  för att ta fram nästa sida. MODBUS TCP/IP

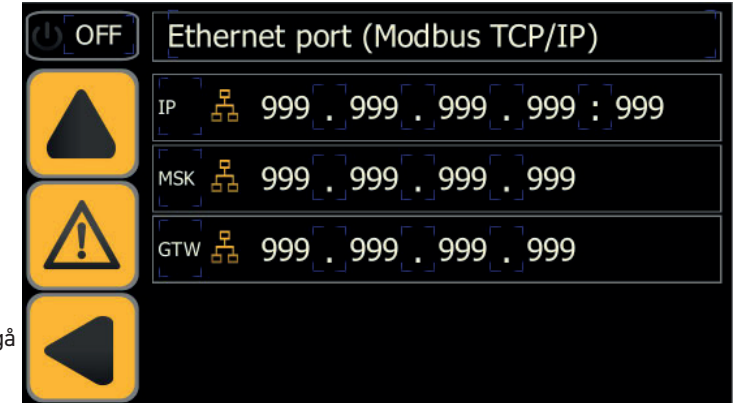

The screenshot shows the 'Ethernet port (Modbus TCP/IP)' screen with a power button labeled 'OFF'. It lists three parameters: 'IP' (999 . 999 . 999 . 999 : 999), 'MSK' (999 . 999 . 999 . 999), and 'GTW' (999 . 999 . 999 . 999). Navigation buttons (up, down, left, right, and a warning icon) are visible on the left side.

Tryck på  för att återgå till föregående meny.

Stäng AV/Sätt PÅ torktumblaren för att bekräfta konfigurationen.

Cloud

Tryck på  för att se "Password" till Cloud.

Det här alternativet pågår.

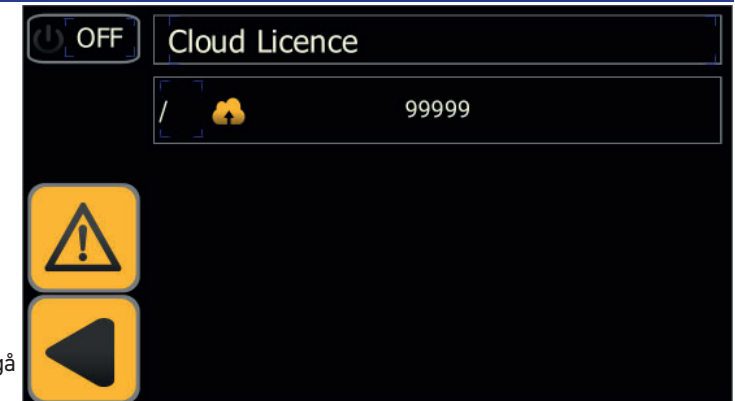

The screenshot shows the 'Cloud Licence' screen with a power button labeled 'OFF'. It displays a password field with a cloud icon and the value '99999'. Navigation buttons (up, down, left, right, and a warning icon) are visible on the left side.

Tryck på  för att återgå till föregående meny.

5.3 Larm/Varningar

Tryck på  för att ta fram menyn "Larm/Varningar":

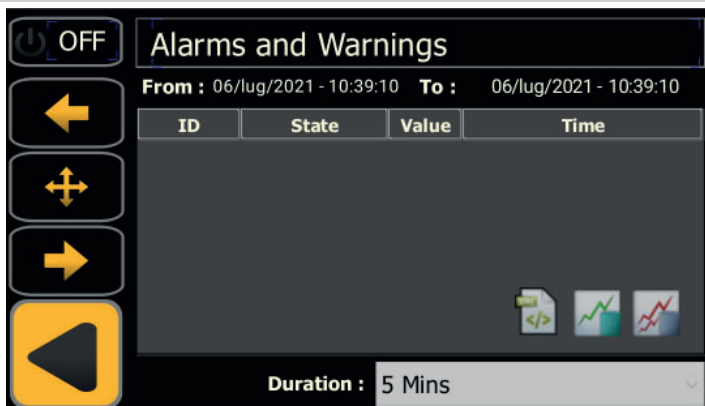



Tryck på "duration" för att ändra tid för forskning.

När de nominella arbetsförhållandena har återställts, så återställs vissa larm och varningar automatiskt medan andra larm/varningar måste återställas manuellt.

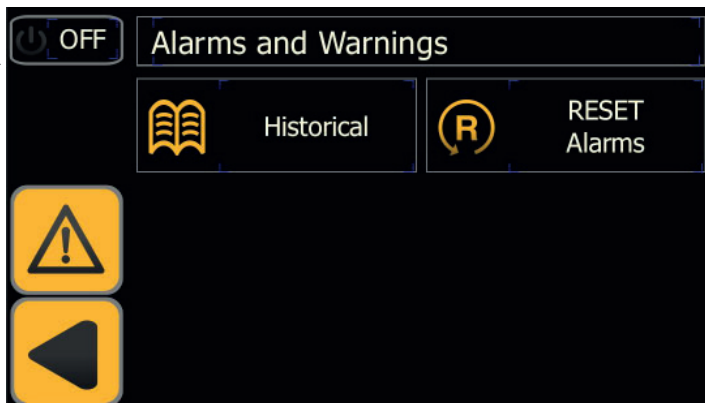
Tryck på  för att återställa larmet.



Tryck på  för att visa de historiska larmen med:
larmkod, datum, antal larm, position i förekomstsekvensen och larmens aktiveringstid.

Tryck på  för att återgå till föregående meny.

5.3.1 Lista över larm/varningar

a = larm; w = Varning.

Code	Larm/Varning	Cause
aLD	Larm för låg daggpunkt	temperaturen B0<A9 för mer än A10 sekunder .
aLT	Larm låg förångningstemperatur	temperaturen B2<A12 för mer än A13 sekunder
aHT2	Larm - tömningstemperatur för hög	temperaturen B8>A11
aHP	Larm för högtryck	Högtrycksvakt aktiv
aLP	Termolarm för lågttryck	Lågtrycksbrytare aktiv
aLTA	Larm låg temperaturen multicooter	temperaturen B4<A12 för mer än A13 sekunder
aPI*	Larm Termolarm för kompressorn	Termolarm för kompressorn aktiv
aPH	Larm Fasmonitor	Fasmonitor aktiv (för 460-750)
aCM1	Larm kommunikation expansion 1	expansion 1 kommunicerar inte
aCM2	Larm kommunikation expansion 2	expansion 2 kommunicerar inte
wB0	Varning sond B0	sonden trasig eller inte ansluten
wB2	Varning sond B2	sonden trasig eller inte ansluten
wB4	Varning sond B4	sonden trasig eller inte ansluten
wB5	Varning sond B5	sonden trasig eller inte ansluten
wB6	Varning sond B6	sonden trasig eller inte ansluten
wB8	Varning sond B8	sonden trasig eller inte ansluten
aFP1	Larm Högtrycks sändaret P1	sändaret trasig eller inte ansluten
wHD	varningar för låg daggpunkt	temperaturen B0>A6 för mer än A8 minuter
wHT1	Varning tömningstemperatur för hög	temperaturen B8>A14 för mer än A15 minuter
wHP1	Varning Högtrycks	tryck P1>A16 för mer än 2 sekunder
wHB5	Varning hög sugtemperatur	temperaturen B5>A18 för mer än 1 minuter
wLP2	Varning för lågt tryck	tryck P2<A21 för mer än 150 sekunder
wSR	Varning Programmerat underhåll	servicetiden har förflutit
wDR1	Varning kondensavledare 1	kondensatet släpps inte ut cooler 1
wDR2	Varning kondensavledare 2	kondensatet släpps inte ut cooler 2
wDR3	Varning kondensavledare 3	kondensatet släpps inte ut cooler 3
aFP2	Larm lågtrycks sändaret P2	sändaret trasig eller inte ansluten

* för modeller från 900-1800 kan larmet också ha innebörden av inverterade faser.

5.4 Snabbmeny

Ta fram menyn i korta steg:

Visa temperaturen

Tryck på  → Tryck på  Tryck på temperaturen för att se grafiken.

Visa trycket

Tryck på  → Tryck på  Tryck på temperaturen för att se grafiken.

Nedladdning

Tryck på  → Tryck på  för nedladdning.

Serial number date

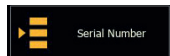
Tryck på  → Tryck på .

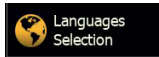

Ändra språk

Tryck på  → Tryck på  → Tryck på  Välj ditt språk.

Datum/Timme

Tryck på  → Tryck på  → Tryck på  Uppdatera klockan.

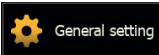
Ändra mätenhet från °C till °F, Fjärr, DEF

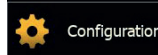
Tryck på  → Tryck på  → Tryck på  → Tryck på .

Tryck på parametern "°C" eller "°F" för att göra ändringen.

Aktivera/avaktivera parametern "Fjärr ON/OFF".

Tryck på "DEF" för att återställa parametern.

Växla till "cyklisk" drift

Tryck på  → Tryck på  → Tryck på  → Tryck på 

Ändra driftläget.

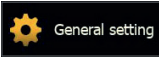
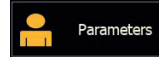
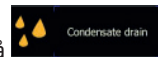

Dränering

Tryck på  → Tryck på  → Tryck på  → Tryck på  Välj dränering.

Modbus

Tryck på  → Tryck på  → Tryck på  → Tryck på 

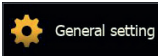
Ställa in parameter

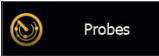
Tryck på  v  → Tryck på  → Tryck på  och ändra parametern..

Larm / Varning

Tryck på  → Tryck på  för att hitta historiskt larm och återställa larm.

Tryck på  för att se ditt historiska larm.

Tryck på  för att återställa larmet.

6 Underhåll

- Maskinen är konstruerad och byggd för kontinuerlig drift, men livslängden hos maskinens komponenter beror på det underhåll som utförs.
-  Vid begäran om hjälp eller beställning av reservdelar, identifiera maskinen (modell och serienummer) med hjälp av uppgifterna på typskylten.
- Kretsar innehållande 5t < xx < 50t CO2 ska inspekteras avseende läckage minst en gång om året. Kretsar innehållande 50t < xx < 500t CO2 ska inspekteras avseende läckage åtminstone var sjätte månad. ((EU) št 517/2014 art. 4.3.a, 4.3.b).
- För maskiner innehållande 5t CO2 eller mer måste operatören föra en journal över mängden och typen av köldmedel som används, tillsatta volymer och volymer som återvunnits vid underhåll, reparationer och slutlig kassering ((EU) št 517/2014 art. 6).

6.1 Allmän information

 Kontrollera följande innan någon typ av underhåll görs:

- att tryckluftskretsen inte är under tryck,
- Storkaren är skild från elnätet.

 Använd alltid original reservdelar från tillverkaren. Om original reservdelar inte används accepterar tillverkaren inget ansvar för funktionsstörningar på maskinen.

 Vid kylmedelsläckage, kontakta en auktoriserad fackman.

 Schraderventilen skall endast användas vid funktionsstörningar på maskinen. I annat fall godkänns inte skadorna orsakade av en felaktig påfyllning av kylmedel inom ramen för garantin.

6.2 Kylmedel

Påfyllning: eventuella skador som beror på felaktig kylmedelspåfyllning utförd av icke auktoriserad personal täcks inte av garantin. 















 Apparaten innehåller fluorerad växthusgas.

Kylvätskan R513A är vid normal temperatur och normalt tryck en ofärgad gas tillhörande SAFETY GROUP A1 - EN378 (vätskegrupp 2 enligt direktiv PED 2014/68/EU); GWP (Global Warming Potential) = 573..

 Vädra lokalen i händelse av kylmedelsläckor.

6.3 PProgram för förebyggande underhåll

Gör följande för att garantera att torkaren blir maximalt effektiv och tillförlitlig



Beskrivning av underhållsåtgärder	Underhållsintervall (vid standard funktionsvillkor)				
	Varje dag	Varje vecka	Var 4:e månad	Var 12:e månad	Var 36:e månad
Åtgärd kontrollera  Service 					
Kontrollera att kontrolllampan POWER ON lyser.					
Kontrollera indikatorerna på kontrollpanelen.					
Rengör det tryckvaktsventil för vatten om det inte är smutsigt öka inspektionsintervallet (se instruktioner) (PSE750-1800)					
Kontrollera kondensavledaren.					
Rengör kondensatorns flänsar.					
Kontrollera den upptagna effekten.					
Kontrollera att det inte finns kylmedelsläckor.					
Töm trycket ur anläggningen. Utför underhållet på avledaren.					
Töm trycket ur anläggningen. Byt anordningarna på för- och efterfiltren.					
Kontrollera temperatursonderna. Byt vid behov.					
Underhållssats till torkare.				 	
Dryer maintenance kit.					

Följande kan beställas (se avsnittet 8.4):

- Sats för förebyggande underhåll vart 3:e år.
- servicesats:
 - kompressorsats,
 - fläktsats,
 - satser för varmgasventil
 - satser för vattenkondensator
- lenskilda reservdelar.

6.4 Isärtagning

Kylvätskan och smörjoljan som finns i kretsen måste återvinnas enligt gällande lokala miljöbestämmelser. Återvinningen av kylmedel är utförd före den slutgiltiga förstöringen av apparaten ((EU) Nr 517/2014 art.8).

	Återvinning Isärtagning 
snickerier	stål/epoxy-polyesterhartser
värmväxlare	aluminium
rör/samlingsrör	koppar/aluminium/kolstål
avledare	polyamide
värmväxlarens isolering	EPS (sintrad polystyren)
rörisolering	syntetgummi
kompressor	stål/koppar/aluminium/olja
kondensator	stål/koppar/aluminium
kylmedel	R513A
ventiler	mässing
elektriska kablar	koppar/PVC

Utrustning som innehåller elektriska komponenter måste kasseras separat med elektriskt och elektroniskt avfall enligt lokal och aktuell lagstiftning.



7 Felsökning

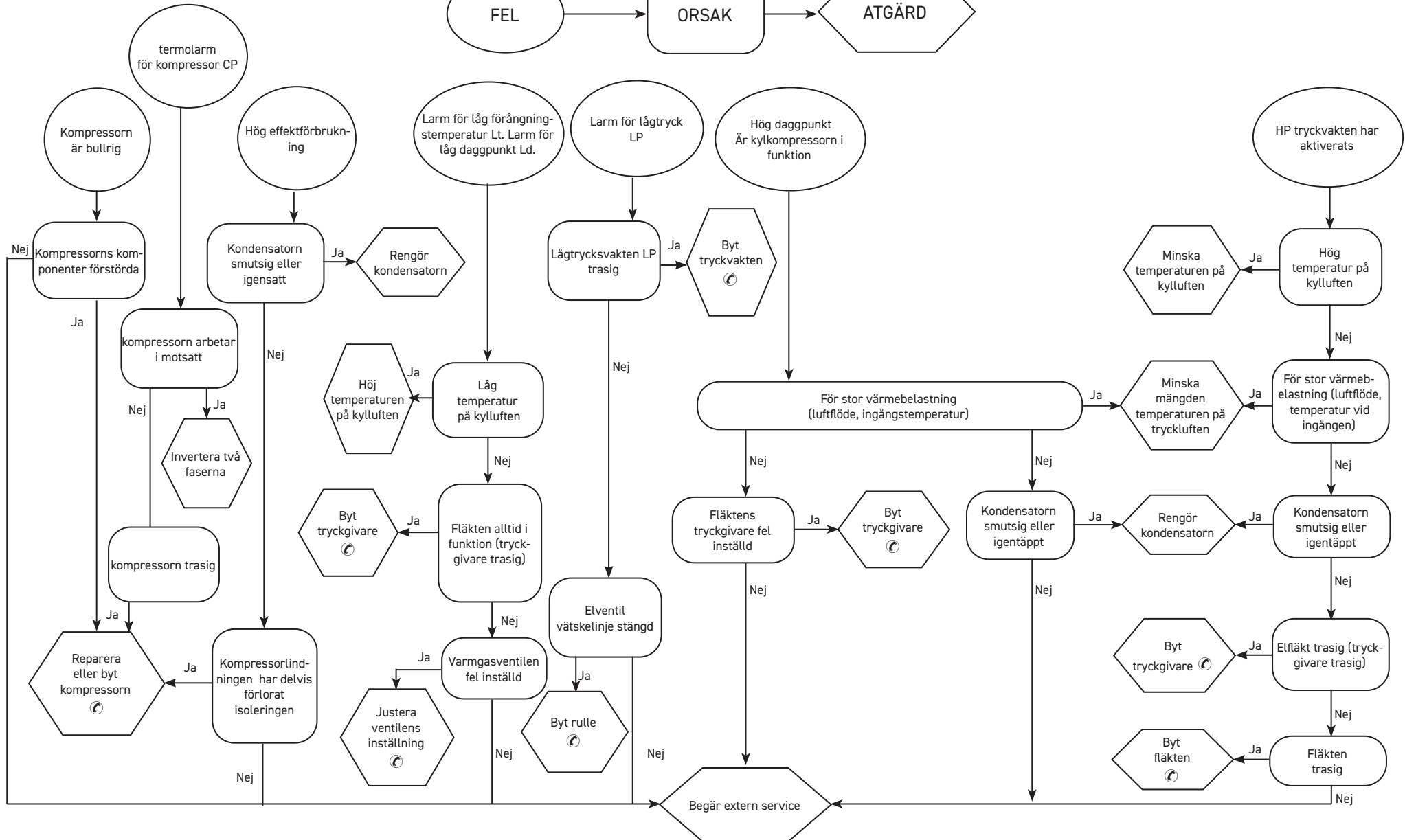

Index





1 Veiligheid	1
1.1 Belang van de handleiding.....	1
1.2 Waarschuwingstekens.....	1
1.3 Veiligheidsaanwijzingen.....	1
1.4 Overig gevaar.....	2
2 Inleiding	2
2.1 Transport.....	2
2.2 Hantering.....	2
2.3 Inspectie.....	2
2.4 Opslag.....	2
3 Installatie	3
3.1 Procedures.....	3
3.2 Werkruimte.....	3
3.3 Uitvoeringen condensor.....	3
3.4 Aanbevelingen.....	3
3.5 Elektrische aansluiting.....	3
3.6 Aansluiting voor condensafvoer.....	3
4 Inwerkingstelling	4
4.1 Voorbereidende controles.....	4
4.2 Starten.....	4
4.3 Gebruik.....	4
4.4 Stoppen.....	4
5 Bediening	5
5.1 Bedieningspaneel.....	5
5.2 Hoofdmenu.....	5
5.2.1 Machinestatus (I/O).....	5
5.2.2 Druk.....	6
5.2.3 Temperatuur.....	6
5.2.4 Download.....	7
5.2.5 Serienummer datum.....	7
5.2.6 Algemeen.....	7
5.2.6.1 Taal.....	7
5.2.6.2 Datum/Tijd.....	7
5.2.6.3 User menu.....	8
5.2.6.4 Parameters.....	8
5.3 Alarmen/waarschuwingen.....	10
5.3.1 Lijst van alarmen/waarschuwingen.....	10
5.4 Snelmenu.....	11
6 Onderhoud	12
6.1 Algemene waarschuwingen.....	12
6.2 Koelvloeistof.....	12
6.3 Preventief onderhoudsprogramma.....	12
6.4 Afdanken.....	13
7 Opsporen van storingen	14
8 Appendix	

1 Veiligheid







1.1 Belang van de handleiding

- Tijdens de gehele levensduur van de machine bewaren.
- Voor iedere operatie eerst lezen.
- Is onderhevig aan wijzigingen: voor bijgewerkte informatie de versie op de machine lezen.

1.2 Waarschuwingstekens

	Instructies om gevaarlijke situaties voor personen te voorkomen.
	Instructie om schade aan het apparaat te voorkomen.
	Vereist de aanwezigheid van een ervaren en bevoegde technicus.
	De betekenis van de aanwezige symbolen wordt verklaard in paragraaf 8.1

1.3 Veiligheidsaanwijzingen

-  Iedere unit is met een veiligheidsschakelaar uitgerust om in veilige omstandigheden te kunnen werken. Maak altijd van deze voorzieningen gebruik om gevaarlijke situaties tijdens onderhoud te voorkomen.
-  Deze handleiding is bestemd voor de eindgebruiker en alleen voor werkzaamheden met gesloten panelen: ingrepen waarvoor de machine met gereedschap moet worden geopend, mogen uitsluitend door ervaren en gekwalificeerd personeel worden uitgevoerd.
-  Zorg ervoor de limieten op het gegevensplaatje niet te overschrijden.
-  De gebruiker dient andere belastingen dan de statische interne druk te voorkomen. In aardbevingengebieden moet de unit adequaat worden beschermd.
-  De veiligheidsinrichtingen op het perslucht circuit komen ten laste van de gebruiker.
-  Bij de berekening van de afmetingen van de veiligheidsinrichtingen van het perslucht circuit moet rekening worden gehouden met de technische kenmerken van het systeem en de geldende plaatselijke wet- en regelgeving.
- Gebruik de unit uitsluitend voor professionele doeleinden en voor het doel waarvoor deze is ontworpen. Het is de taak van de gebruiker om alle aspecten van de toepassing waarin het product geïnstalleerd wordt te analyseren, en alle geldende veiligheidsnormen in de bedrijfstak en alle voorschriften met betrekking tot het product in de gebruiksaanwijzing en alle andere bij de unit geleverde documentatie op

te volgen.

Het forceren of vervangen van een willekeurige component door onbevoegd personeel en/of het oneigenlijk gebruik van de unit ontheffen de fabrikant van elke aansprakelijkheid en maken de garantie ongeldig. Iedere huidige en toekomstige aansprakelijkheid voor schade aan personen, zaken en aan de unit zelf, die het gevolg zijn van nalatigheid van de operateurs, van het niet naleven van de instructies in deze handleiding, van het niet toepassen van de geldende voorschriften met betrekking tot de veiligheid van de installatie komt te vervallen.

De fabrikant aanvaardt geen aansprakelijkheid voor eventuele schade die te wijten is aan veranderingen en/of wijzigingen van de verpakking.

Het is de verantwoordelijkheid van de gebruiker om ervoor te zorgen dat de geleverde lijst voor het selecteren van de unit of van onderdelen en/of opties compleet is, teneinde een correct of redelijkerwijs voorspelbaar gebruik van de unit of van de onderdelen te garanderen.

 **LET OP:** de fabrikant behoudt zich het recht voor de informatie in dit handboek zonder enige waarschuwing vooraf te wijzigen.

Voor volledige en actuele informatie raden wij de gebruiker aan het bij de fabrikant.

1.4 Overig gevaar

Installatie, start, uitschakelen en onderhoud van de machine mag uitsluitend uitgevoerd worden op grond van hetgeen beschreven staat in de technische documentatie en in elk geval zodanig dat gevaar vermeden wordt. Onderstaande tabel vermeldt eventueel gevaar dat men tijdens het ontwerpen van de machine niet heeft kunnen voorkomen.

betreffend deel	bestaand gevaar	oorzaak	voorzorgsmaatregel
batterij voor warmteuitwisseling	kleine snijwonden	aanraking	vermijd aanraking, gebruik veiligheidshandschoenen
ventilatorrooster en ventilator	persoonlijk letsel	steken van scherpe voorwerpen in het rooster terwijl de ventilator beweegt	steek nooit voorwerpen in het ventilatorrooster en leg niets op de roosters
in de machine: compressor en toevoering	brandwonden	aanraking	vermijd aanraking, gebruik veiligheidshandschoenen
in de machine: metaaldelen en elektrische kabels	vergiftiging, fulgoratie, ernstige brandwonden	slecht geïsoleerde voedingskabels naar elektrisch schakelbord van de unit met onder spanning staande metaaldelen	voer de elektrische isolatie van de voedingslijn naar behoren uit; voer de aarding van de metaaldelen nauwkeurig uit
buiten de machine: omliggende ruimte	vergiftiging, ernstige brandwonden	brand tengevolge van kortsluiting of oververhitting van de voedingslijn naar het elektrisch schakelbord van de machine	kabelsectie en beveiligingssysteem van de elektrische voedingslijn in overeenstemming met de geldende normen

2 Inleiding

Deze handleiding heeft betrekking op koeldrogers die zijn ontworpen om waterdamp uit perslucht te verwijderen.

2.1 Transport

De verpakte eenheid moet:

- in een verticale positie worden gehouden;
- beschermd worden tegen atmosferische invloeden;
- beschermd worden tegen botsingen en stoten.

2.2 Hantering

Gebruik een vorkheftruck die geschikt is voor het te tillen gewicht en vermijd botsingen tegen de verpakking.

2.3 Inspectie

- In de fabriek worden alle units geassembleerd, bedraad, gevuld met koelmiddel en olie, en getest volgens de standaard bedrijfsomstandigheden;
- controleer bij ontvangst de staat van de machine: protesteer geef eventuele schade gelijk aan bij het transportbedrijf;
- pak de eenheid uit in de buurt van de installatieplaats.

2.4 Opslag

Als meerdere eenheden boven elkaar moeten worden geplaatst, de opmerkingen op de verpakking opvolgen. De verpakte eenheid op een schone plaats en beschermd tegen vocht en weersinvloeden opslaan.

3 Installatie

☞ Installeer binnen in een schone, droge ruimte die is beschermd tegen de elementen, direct zonlicht en / of andere zware omstandigheden.

⚠ Het geïnstalleerde product moet op passende wijze worden beschermd tegen brandgevaar (ref. EN378-3).

3.1 Procedures

⚠ Bij de modellen eerst de platkopschroeven in de flensen draaien tot hun eindaanslag alvorens de tegenflensen te monteren (zie paragraaf 8.6).

☞ De aanwijzingen uit de paragrafen 8.2 en 8.3 opvolgen.
Alle drogers dienen voorzien te zijn van een passend voorfilter dat zo dicht mogelijk bij de inlaat van de droger gemonteerd dient te worden. De verkoper is nimmer aansprakelijk of verplicht tot schadevergoeding voor elke directe of indirecte schade veroorzaakt door het ontbreken hiervan.

☞ Het voorfilterelement (voor filtering tot 3 micron of lager) moet minstens eenmaal per jaar worden vervangen of na de periode die door de fabrikant is aangegeven.

☞ Sluit de droger op correcte wijze aan op de aansluitstukken voor de ingang/uitgang van de perslucht.

3.2 Werkruimte

☞ Zorg voor een vrije ruimte van 1,5 meter rondom de eenheid.
Zorg bij modellen met een verticale afvoer van de condenslucht voor een vrije ruimte van 2 meter boven de droger.

3.3 Uitvoeringen condensor

Uitvoering met lucht (Ac)

Zorg dat er geen situaties van hercirculatie van de koellucht kunnen ontstaan. Sluit de ventilatieroosters niet af.

Uitvoering met water (Wc)

Installeer een netfilter op de inlaat van het condenswater, indien de machine zonder filter is geleverd.

☞ Kenmerken van het condenswater bij inlaat:

Temperatuur	≥50°F (10°C)	CL ⁻	<50 ppm
ΔT IN/OUT	5-15°C	CaCO ₃	70-150 ppm
Max % glycol	50	O ₂	<0.1 ppm
Druk	43.5-145 PSig (3-10 barg)	Fe	<0.2 ppm
PH	7.5-9	NO ₃	<2 ppm
Elektrisch geleidings- vermogen	10-500 μS/cm	HCO ₃ ⁻	70-300 ppm
Verzadigingsgraad van Langelier	0-1	H ₂ S	<0.05 ppm
SO ₄ ²⁻	<50 ppm	CO ₂	<5 ppm
NH ₃	<1 ppm	Al	<0.2 ppm

Voor speciale soorten koelwater (gedeïoniseerd, gedemineraliseerd, gedistilleerd) zijn de standaard materialen die voor de condensor voorzien zijn mogelijk niet geschikt. Neem in dat geval contact op met de fabricant.

3.4 Aanbevelingen

Om de interne componenten van de droger en de luchtcompressor niet te beschadigen, de machine niet installeren in een ruimte waar de omgevingslucht verontreinigende stoffen of dampen bevat: let dus op zwavel, ammoniak, chloor, en bij installaties in een zeemilieu. Voor de uitvoeringen met axiale ventilator is de kanalisatie van de verbruikte lucht afgeraden.

3.5 Elektrische aansluiting

Gebruik een kabel die voldoet aan de lokale wetten en voorschriften (zie voor de minimale kabeldoorsnede paragraaf 8.3).

Installeer de thermomagnetische differentieelschakelaar (RCCB - IDn = 0.3A) bovenstrooms van de installatie met een afstand tussen de contacten bij een geopende schakelaar 3 mm (zie de toepasselijke plaatselijke voorschriften).

De nominale stroom "In" van deze installatieautomaat moet gelijk zijn aan FLA en de D-curve.

Selecteer de voeding en plaats een brug zoals hieronder weergegeven:

S7-S6 om 400/3/50

S8-S6 om 460/3/60

Binnenin het elektrische paneel zit een instructielabel.

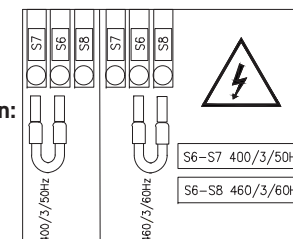

3.6 Aansluiting voor condensafvoer

☞ Maak een aansluiting met het afvoersysteem en vermijd de aansluiting op een gesloten circuit waarop reeds andere onder druk staande afvoerlijnen zijn aangesloten. Controleer of de condens op de juiste wijze in het afvoerkanaal wegvloeit. Alle condens moet in overeenstemming met de plaatselijke geldende milieuvoorschriften worden afgevoerd.

4 Inwerkingstelling

4.1 Voorbereidende controles

Voordat u de droger in werking stelt, dient u ervoor te zorgen dat:

- de installatie is uitgevoerd volgens de instructies in paragraaf 3;
- de luchtingangskleppen gesloten zijn en er geen luchtstroom door de droger is;
- de netvoeding correct is;
- bij de Wc-versie het koelwatercircuit enkele minuten voor het starten van de droger geopend wordt.

4.2 Starten

1. schakel de stroom in door de HOOFDSCHAKELAAR “



” op “I ON” te zetten.

HET VERWARMINGSELEMENT VAN DE KRANKKAST MOET 12 UUR VOORDAT DE DROGER GESTART WORDT, WORDEN INGESHAKELD.

Daarna, Raak om terug te keren naar het bedieningspaneel



2. Raak aan om het apparaat te starten; de knop verandert van grijs in groen om aan te geven

dat de droger nu in werking is .

- c) Start de droger voor de luchtcompressor;

Het niet naleven van deze regel kan ernstige schade aan de compressor veroorzaken.

Ventilator (Ac-versie): als deze aangesloten is met de verkeerde fasesequentie draait hij de verkeerde kant op, met het risico op beschadiging (in dit geval verlaat de lucht de kast van de droger door het condensorrooster in plaats van door het ventilatorrooster - zie par.8.6/8.7 voor de juiste luchtstroming); keer de twee fasen onmiddellijk om.

4. Wacht 5 minuten en open vervolgens langzaam de luchtinlaatklep;

5. open de luchtuitlaatklep langzaam: de droger droogt nu.

Fasebewaking

Als er een alarm verschijnt tijdens het opstarten van de droger, moet de gebruiker de bedrading van de ingangsklemmen van de hoofdschakelaar van de droger controleren.

4.3 Gebruik

- Laat de droger ingeschakeld gedurende de gehele periode dat de luchtcompressor werkt;
- De droger werkt in de automatische modus, daarom zijn er geen lokale instellingen nodig;
- Voer in het geval van onverwachte overmatige luchtstromen een bypass uit om overbelasting van de droger te voorkomen.
- Vermijd temperatuurschommelingen van de luchtinlaa.

4.4 Stoppen

1. Stop de droger 2 minuten nadat de luchtcompressor gestopt is, of in ieder geval na onderbreking van de luchtstroom;
2. zorg dat de geprimeerde lucht de droger niet binnenkomt wanneer deze uitgeschakeld is of als er een alarm optreedt.



Druk op om de droger uit te schakelen. De toets wordt grijs



3. Zet de HOOFDSCHAKELAAR “” op “O OFF” om de stroom uit te schakelen.



Wc-versie: sluit het watercircuit wanneer de droger gestopt is.

5 Bediening

5.1 Bedieningspaneel

Aanraaktoetsen	Functie
	Dryer UIT (grijs)
	Dryer AAN (groen)

LOCAL = Lokaal configuratie
REMOTE = Fernbediening config.

Functie	Aanraaktoetsen	Functie
 FS 48 % Werkingssnelheid ventilator (alleen voor luchtcondensatorversie)		Toegang tot het informatiemenu: machinestatus, drukwaarden, temperaturen, algemene instellingen, verbruik, gebruikerswachtwoord
 HGBV 14 % Werkingssnelheid heetgasklep		Grijs = geen alarmen Rood = waarschuwingen Rood Knippert = alarmen
 ECO 0% Energiebesparend% (Cyclus)		Dryer UIT = lichtgrijs Cycling actief = groen knipperend Compressor actief = lichtblauw
 Trend dauwpunt		grijs = Condensafvoer OFF groen = Condensafvoer ON

Functie	Aanraaktoetsen	Functie
 PDP 8.0 Trend dauwpunt		Raak: voor een handmatige afvoer
		Funktion Strep led: blauw = Compressor actief groen = Energiebesparend Rood = alarmen

5.2 Hoofdmenu

Raak aan om het menu "Informatie" te openen:
 Wanneer een van de "aanraaktoetsen" wordt aangeraakt, licht de omligging een paar seconden op om te bevestigen dat de selectie gemaakt is.
 Dit geldt voor elke "aanraaktoets" op het bedieningspaneel.
 Raak aan om terug te keren naar het bedieningspaneel.

5.2.1 Machinestatus (I/O)

Raak aan om het menu "machinestatus" te openen.
 Dit is de lijst van invoeren:
 Een led bij de beschrijving geeft aan of de beschermingen / functies / configuraties: actief zijn = groen lampje, niet actief zijn = grijs lampje.
 Raak aan om naar de volgende pagina te gaan.
 Dit is de lijst van uitvoeren:



Raak aan om terug te keren naar het vorige menu.

5.2.2 Druk

Raak  om het menu "druk" te openen en het volgende weer te geven: condensatiedruk, werkingssnelheid ventilator, verdampingsdruk, werkingssnelheid heetgasklep.



Raak een specifieke parameter aan om de gegevenstrend van prestaties in de loop van de tijd te bekijken.

"Condensatie-/verdampingsdruk"

Gebruik  en  om door de grafiek te scrollen.

Raak  aan om terug te keren naar het vorige menu.

"Werkingsnelheid heetgasklep/ventilator"

Gebruik  en  om door de grafiek te scrollen.

Raak  aan om terug te keren naar het vorige menu.

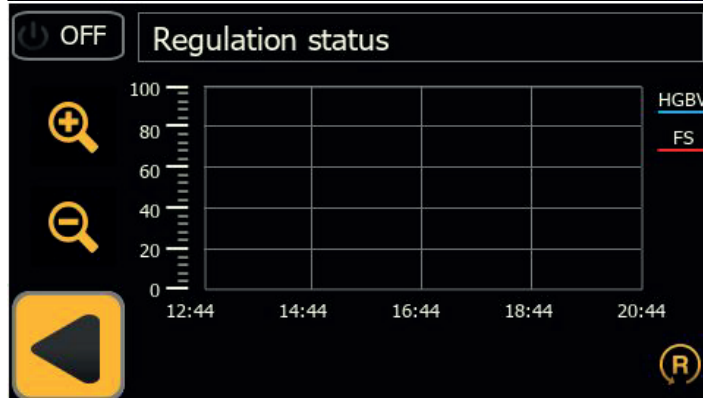
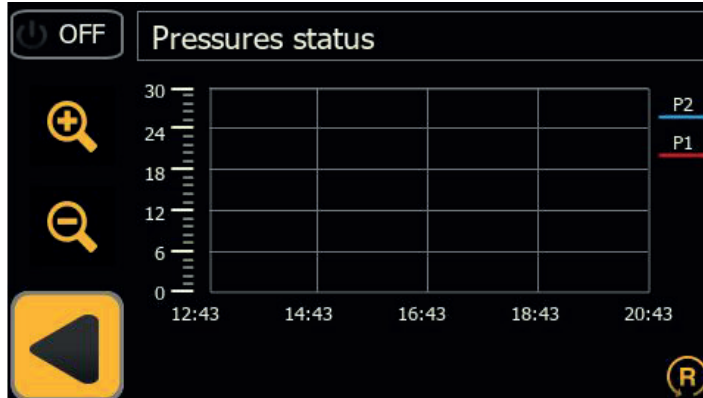
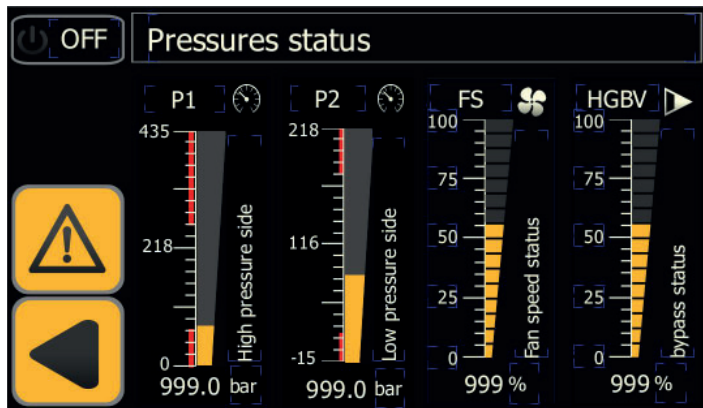

5.2.3 Temperatuur

Raak  aan om temperatuuruitlezingen van de temperatuursondes van het circuitdiagram weer te geven.



Raak  aan om naar de volgende pagina te gaan.

B4 = alleen actief voor versie Multicooler.

Raak een van de lage-druktemperaturen aan om een gegevenstrend van alle sondes in het lagedrukcircuit te zien.



Raak een van de hogedruktemperatuurwaarden aan om een gegevenstrend van alle sondes in het hogedrukcircuit te zien.

Temperatuur - Lagedrukzijde

Gebruik  en  om door de grafiek te scrollen.

Raak  aan om terug te keren naar het vorige menu.

Temperatuur - Hogedrukzijde

Gebruik  en  om door de grafiek te scrollen.

Raak  aan om terug te keren naar het vorige menu.

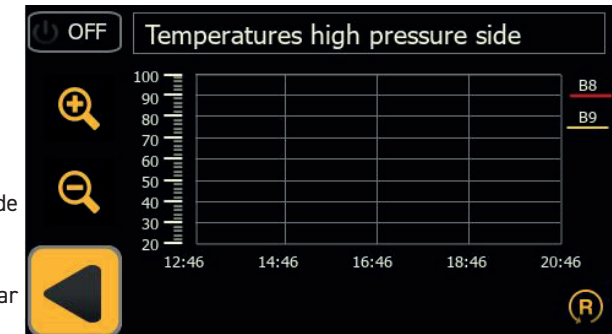
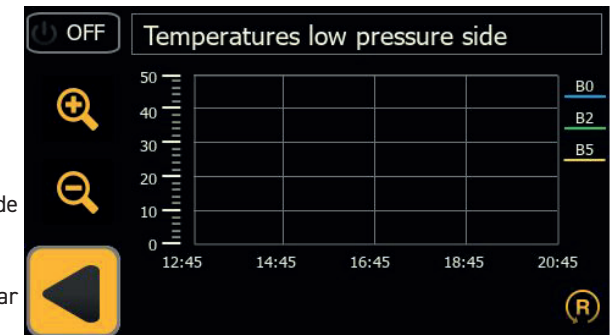
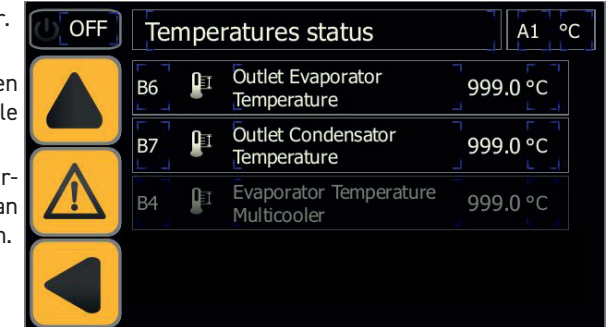
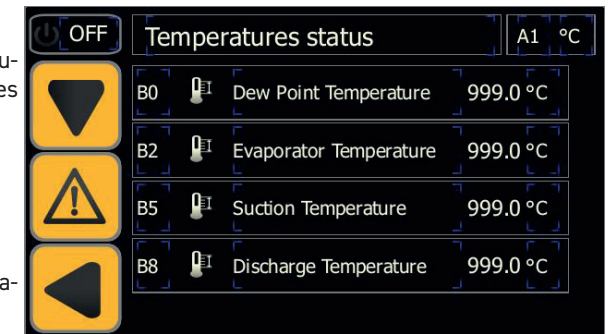

5.2.4 Download

Gebruik een USB met led, die je de downloadfase laat zien.
(8 GB geformatteerd als FAT32) in het voorpaneel steken.

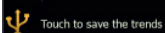
Raak  om het downloaden te starten.
De downloadtijd van de gegevens hangt af van de hoeveelheid opgeslagen gegevens.

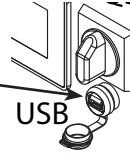

5.2.5 Serienummer datum

Raak  aan om het menu "serial number" te openen.

OFF	Serial number
	HMI version: 1.520.20
	PLC version: 9.999
	PSE serial number 999999999999
	IP address 172.18.238.213

Raak  aan om terug te keren naar het bedieningspaneel.

5.2.6 Algemeen

Raak  aan om het menu "algemeen" te openen met de volgende onderdelen: taal; datum/tijd; parameters; onderhoud; afwisselende/continue werking.
Raak een menu aan om te bekijken / aan te passen.

Raak  aan om terug te keren naar het bedieningspaneel.

OFF	Languages Selection
	Set Data Time
	Parameters
	Users access

5.2.6.1 Taal

Raak  aan om het taalmenu te openen.
Raak de gewenste taal aan.
U keert automatisch terug naar het hoofdmenu in de gekozen taal.

Raak  aan om terug te keren naar het vorige menu.

Raak de gewenste taal aan.
U keert automatisch terug naar het hoofdmenu in de gekozen taal.

Raak  aan om terug te keren naar het vorige menu.

OFF	English	Italian	German
	Czech	Polish	Slovak

OFF	French	Spanish	Swedish
	Russian	Dutch	Portuguese

5.2.6.2 Datum/Tijd

Raak  aan om het menu "datum/tijd" te openen.

Raak Tijd /Datum aan om de datum te veranderen.

Druk 2 seconden op

 27/mag/2021 - 17:03:34 Sunday

Druk 2 seconden op om te bevestigen.

Raak  aan om terug te keren naar het vorige menu.

OFF	Set Data Time	
	Wee	Sunday
	Sec Seconds 0	Day Day of month 0
	Min Minutes 0	Mon Month 0
	Hou Hours 0	Yea Year 2000
	Keep touch to set Date and Time 27/mag/2021 - 17:03:34 Sunday	

5.2.6.3 User menu

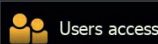
Raak  aan om het menu "User" te openen. Dit menu is gereserveerd voor de servicemonteur van Parker.

User name:

Password:

Show password

5.2.6.4 Parameters

Raak  aan om het menu "parameter" te openen met de volgende onderdelen: sondes, condensafvoer, configuratie, onderhoud, cycli.

Raak de "aanraaktoets" aan om het menu te openen.





Raak  aan om terug te keren naar het vorige menu.

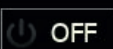

Sondes

Raak  aan om de waarschuwingen en vertragingen of het minimale/maximale dauwpunt in te stellen.

 **Probes**

A6	 Warning high dew point	0.0 °C
A8	 Delay warning high dew point	0'
A9	 Warning low dew point	0.0 °C
A10	 Delay warning low dew point	0 s

Condensafvoer

Raak  aan om het menu "condensafvoer" te openen in te stellen:

1. getimede afvoer (door de sluitings- en openingstijden te kiezen);
2. capacitieve afvoer;
3. continue afvoer (externe afvoer).

Raak  aan om terug te keren naar het vorige menu.

 **Condensate drain**

D3  Modality:





Configuratie

Raak  aan om het configuratiescherm te openen met het volgende menu

1. keuze van temperatuur in °C / °F;
2. activering van de afstandsbediening;
3. activering van alleen alarmen of alarmen/waarschuwingen;
4. terugzetten van de instellingen op de standaardparameters.

Gebruik de "aanraaktoets" bij de beschrijving om uw keuze te maken.

 **Configuration**

A1	 Change °C to °F	°C
A7	 Remote ON/OFF	DISABLED
xJ1	 Alarm mode	ALARM + WARNING
DEF	 Default values	DEF

 Om de REMOTE OFF-modus te beheren, verwijdt u de brug tussen de klemmen: 87 -GND en sluit u de externe start/stop-schakelaar aan (te voorzien door de klant).

Onderhoud

Raak  Maintenance aan om de bedrijfsuren van de compressor/droger te zien.

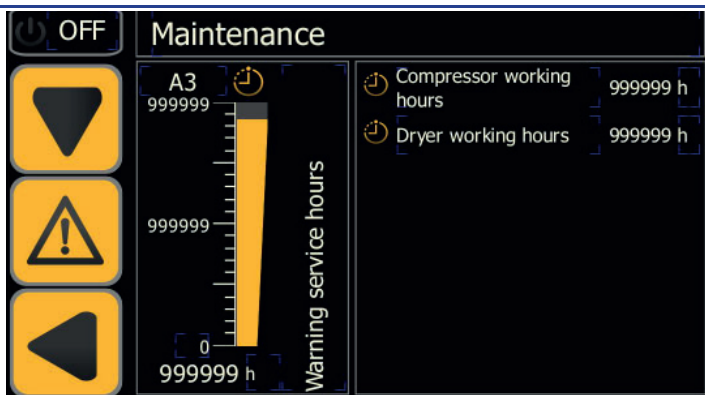

The screenshot shows the 'Maintenance' screen with a power button, a 'Maintenance' icon, and a 'Warning service hours' gauge. The gauge is labeled 'A3' and has a scale from 0 to 999999. To the right, there are two rows of data: 'Compressor working hours' and 'Dryer working hours', both showing '999999 h'.

Raak  aan om terug te keren naar het vorige menu.

Werking

Raak  Cycle aan om het type werking te kiezen: continu; afwisselend (energiebesparing).

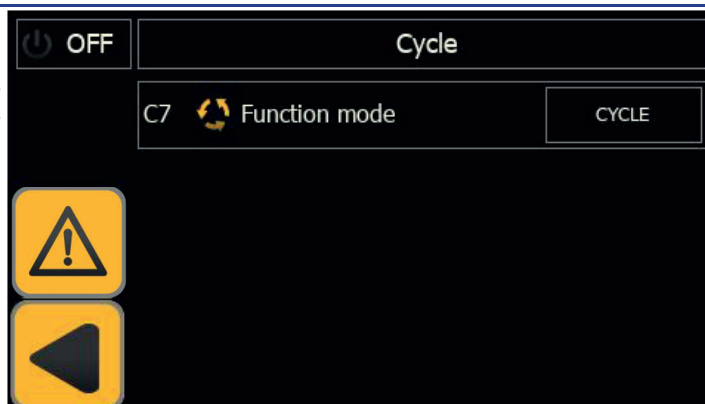

The screenshot shows the 'Cycle' screen with a power button, a 'Cycle' icon, and a 'Function mode' section. The 'Function mode' section shows 'C7' and 'Function mode' with a 'CYCLE' button.

Gebruik de "aanraaktoets" bij de beschrijving om uw keuze te maken.

Raak  aan om terug te keren naar het vorige menu.

Modbus

Touch  om de Modbus-parameters in te stellen.

MODBUS RTU (RS485)

Raak  aan om naar de volgende pagina te gaan.
MODBUS TCP/IP

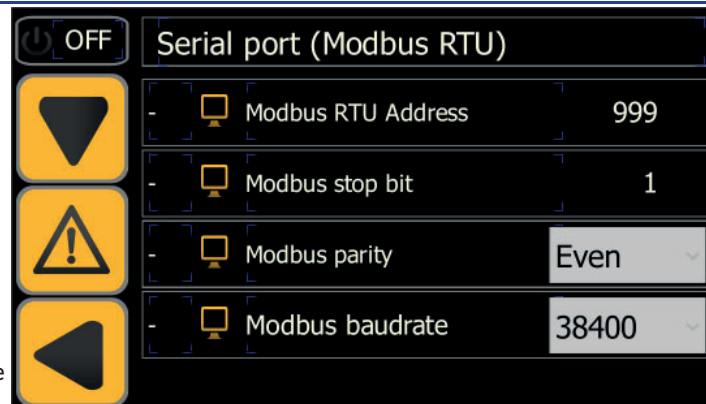

The screenshot shows the 'Serial port (Modbus RTU)' screen with a power button, an 'OFF' button, and a list of parameters: 'Modbus RTU Address' (999), 'Modbus stop bit' (1), 'Modbus parity' (Even), and 'Modbus baudrate' (38400).

Raak  aan om terug te keren naar het vorige menu.

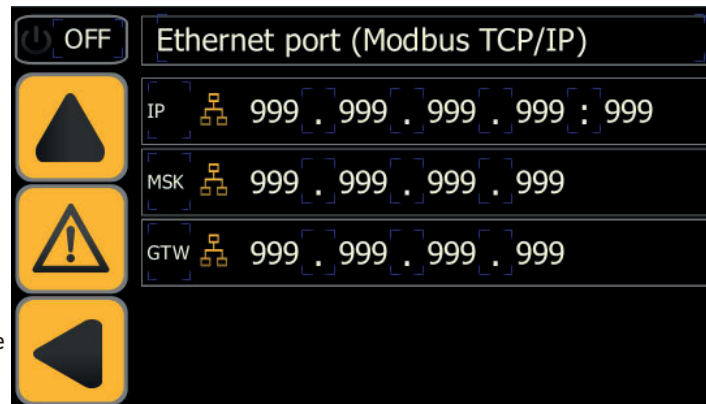

The screenshot shows the 'Ethernet port (Modbus TCP/IP)' screen with a power button, an 'OFF' button, and three rows of IP address fields: 'IP' (999 . 999 . 999 . 999 : 999), 'MSK' (999 . 999 . 999 . 999), and 'GTW' (999 . 999 . 999 . 999).

Schakel de droger UIT/AAN om de configuratie te bevestigen.

Cloud

Raak  om "password" voor cloud te zien.

Deze optie loopt.

Raak  aan om terug te keren naar het vorige menu.



The screenshot shows the 'Cloud Licence' screen with a power button, an 'OFF' button, and a 'Cloud Licence' field containing a password '99999'.

5.3 Alarmen/waarschuwingen

Raak  aan om het menu "alarmen/waarschuwingen" te openen::

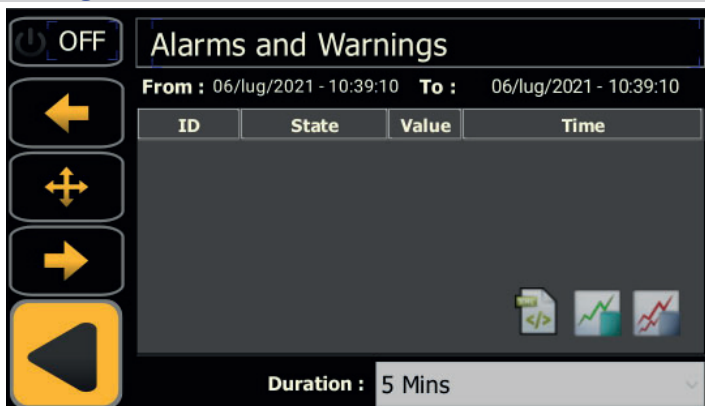

Raak "duration" aan om de onderzoekstijd te wijzigen..

Wanneer de nominale werkingscondities hersteld zijn, worden sommige waarschuwingen en alarmen automatisch gereset; bij andere alarmen/waarschuwingen moet er een handmatige reset worden uitgevoerd.

Raak  aan om het alarm te resetten.

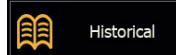
Raak  aan om de historische alarmen weer te geven met:

de alarmcode, de datum, het aantal alarmen, de positie in de volgorde van optreden en het tijdstip van activering van het alarm.

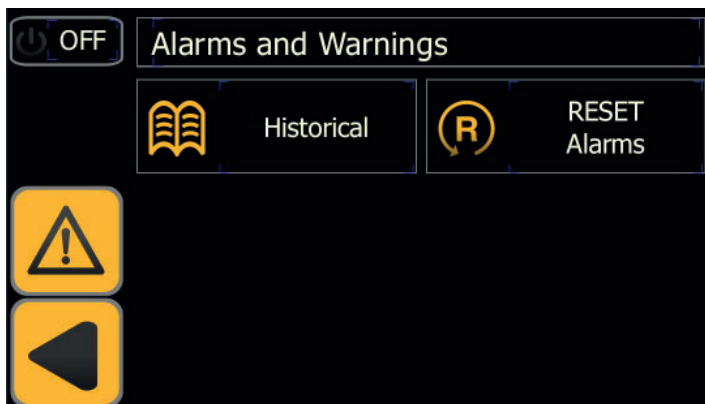

Raak  aan om terug te keren naar het vorige menu.

5.3.1 Lijst van alarmen/waarschuwingen

a = Alarmen; w = waarschuwingen.



Code	Alarmen/waarschuwingen	Oorzaak
aLD	Alarmen Laag dauwpunt	temperatuur B0<A9 voor meer dan A10 seconds.
aLT	Alarmen lage verdampingstemperatuur.	temperatuur B2<A12 voor meer dan A13 seconds
aHT2	Alarmen hoge uitblaastemperatuur	temperatuur B8>A11
aHP	Alarmen Hoge druk	Hogedrukschakelaar geactiveerd
aLP	Alarmen Lage druk	Lagedrukschakelaar is geactiveerd
aLTA	Alarmen Lage temperatuur multicooler	temperatuur B4<A12 voor meer dan A13 seconden
aPI*	Alarmen Temperatuurstijging compressor	Temperatuurstijging compressor geactiveerd
aPH	Alarmen Fasebewaker	Fasebewaker geactiveerd (Voor 460-750)
aCM1	Alarmen communicatie uitbreiding 1	de uitbreiding 1 communiceert niet
aCM2	Alarmen communicatie uitbreiding 2	de uitbreiding 2 communiceert niet
wB0	Waarschuwingen sonde B0	sonde gebroken of niet aangesloten
wB2	Waarschuwingen sonde B2	sonde gebroken of niet aangesloten
wB4	Waarschuwingen sonde B4	sonde gebroken of niet aangesloten
wB5	Waarschuwingen sonde B5	sonde gebroken of niet aangesloten
wB6	Waarschuwingen sonde B6	sonde gebroken of niet aangesloten
wB8	Waarschuwingen sonde B8	sonde gebroken of niet aangesloten
aFP1	Alarmen Hoge druktransmitter P1	druktransmitter gebroken of niet aangesloten
wHD	Waarschuwing hoog dauwpunt	temperatuur B0>A6 voor meer dan A8 minuten
wHT1	Waarschuwing hoge uitblaastemperatuur	temperatuur B8>A14 voor meer dan A15 minuten
wHP1	Waarschuwingen Hoge druk	druk P1>A16 voor meer dan 2 seconds
wHB5	Waarschuwing hoge aanzuigtemperatuur	temperatuur B5>A18 voor meer dan 1 minuten
wLP2	Waarschuwing Lage druk	druk P2<A21 voor meer dan 150 seconden
wSR	Waarschuwingen Geprogrammeerd onderhoud	de servicetijd is verstreken
wDR1	Waarschuwingen Condensafvoer 1	het condensaat komt niet uit cooler 1
wDR2	Waarschuwingen Condensafvoer 2	het condensaat komt niet uit cooler 2
wDR3	Waarschuwingen Condensafvoer 3	het condensaat komt niet uit cooler 3
aFP2	Alarmen Lage druktransmitter P2	druktransmitter gebroken of niet aangesloten

* voor modellen van 900-1800 kan het alarm ook de betekenis hebben van omgekeerde fasen.

5.4 Snelmenu

Bereik het menu in korte stappen:

De temperatuur bekijken

Raak  → Raak  Raak de temperatuur aan om de grafieken te zien.

View the pressure

Raak  → Raak  Raak de druk aan om de grafieken te zien.

Download

Raak  → Raak  aan om te downloaden.

Serienummer datum

Raak  → Raak .

Taal veranderen

Raak  → Raak  → Raak  om uw taal te kiezen.

Tijd /Datum

Raak  → Raak  → Raak  om de klok bij te werken.

Verandering van meeteenheid van °C naar °F, Remote, DEF



Raak  → Raak  → Raak  → Raak .

Raak de parameter "°C" of "°F" aan om de verandering aan te brengen

Schakel de parameter "Remote ON/OFF" in of uit.

Raak "DEF" aan om de parameter te herstellen.

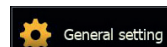
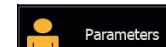
Overschakelen naar "afwisselende" werking

Raak  → Raak  → Raak  → Raak  om de werking te veranderen.

Afvoer

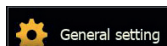
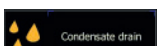
Raak  → Raak  → Raak  → Raak  om uw afvoer te kiezen.



Modbus

Raak  → Raak  → Raak  → Raak 

Setting Parameter

Raak  → Raak  v  v  om de parameter te veranderen.

Alarm / warning

Raak  → Raak  om historisch alarm te vinden en alarm te resetten.

Raak  om uw historische alarm te zien.

Raak  alarm te resetten.

6 Onderhoud

• De machine is ontworpen en gebouwd voor ononderbroken werking; de levensduur van de onderdelen is echter afhankelijk van het uitgevoerde onderhoud.

-  Wanneer u contact opneemt voor assistentie of reserveonderdelen, dient u de machine te identificeren (model en serienummer) met behulp van de gegevens op het typeplaatje op de machine.
- Circuits die 5t < xx < 50t CO2, moeten minimaal eenmaal per jaar gecontroleerd worden op lekkages. Circuits die 50t < xx < 500t CO2, moeten minimaal elke zes maanden gecontroleerd worden op lekkages. ((EU) Nr. 517/2014 art. 4.3.a, 4.3.b).
- Bij machines die 5t CO2 of meer , moet de bediener een registratieblad bijhouden met de hoeveelheid en het type gebruikte koelvloeistof, eventuele toegevoegde hoeveelheden koelvloeistof en hoeveelheden die afgetapt zijn tijdens onderhoudswerkzaamheden, reparaties en definitieve afvalverwerking ((EU) Nr. 517/2014 art. 6).

6.1 Algemene waarschuwingen

 Alvorens een willekeurige onderhoudswerkzaamheid uit te voeren, nagaan of:

- het pneumatisch circuit niet onder druk staat;
- de droger moet van het elektriciteitsnet zijn afgekoppeld.

 Gebruik altijd originele vervangingsonderdelen van de fabrikant: anders is de fabrikant niet aansprakelijk in geval van storingen aan de machine.

 Wendt u in geval van het lekken van het koelmiddel tot ervaren en erkend personeel.

 De Schrader klep mag uitsluitend gebruikt worden wanneer de machine niet naar behoren functioneert: indien de klep toch wordt gebruikt zal de schade, die door het verkeerd laden van het koelmiddel wordt veroorzaakt, niet door de garantie worden gedekt.

6.2 Koelvloeistof

Vullen: eventuele schade als gevolg van een verkeerd uitgevoerde bijvulling van het koelmiddel door onbevoegd personeel valt niet onder de garantie.















 Utstyret inneholder fluoriserende drivhusgasser.

De koelvloeistof R513A is bij een normale temperatuur en normale druk een kleurloos gas en behoort tot de SAFETY GROUP A1 - EN378 (vloeistof groep 2 tweede richtlijn PED 2014/68/EU); GWP (Global Warming Potential) = 573

 Bij lekken van koelvloeistof de ruimte luchten.

6.3 Preventief onderhoudsprogramma

Om ook na verloop van tijd nog verzekerd te zijn van de maximale efficiëntie en betrouwbaarheid van de droger, de onderstaande werkzaamheden uitvoeren:

Beschrijving onderhoudswerkzaamheid	Onderhoudsinterval (onder standaard werksomstandigheden)				
	Dagelijks	Wekelijks	Om de 4 maanden	Om de 12 maanden	Om de 36 maanden
Werkzaamheid controlleren  Service 					
Controleren of het lampje POWER ON brandt.					
De lampjes van het controlepaneel controleren.					
Maak het filter van het waterpressostatische klep schoon, als het niet vuil is, verleng dan het inspectie-interval (zie instructies) (PSE750-1800)					
De condensafvoer controleren					
De vinnen van de condensor reinigen					
Controleer of de carterverwarming correct geplaatst is.					
De stroomopname controleren.					
Controleer de koelmiddellekken.					
Haal de druk van het systeem. Onderhoud uitvoeren op de afvoer.					
Haal de druk van het systeem. De elementen van de voor- en nafilters vervangen.					
Controleer temperatuursondes. Vervang indien nodig.				 	
Onderhoudsset droger.					



Beschikbaar zijn (zie paragraaf 8.4):

- onderhoudskits voor 3 jaar;
- servicekits:
 - compressorkits;
 - ventilatorkits;
 - heetgasklep-kits;
 - watercondensorkits;
- losse vervangingsonderdelen.

6.4 Afdanken

De koelvloeistof en de smeerolie in het circuit moeten worden verwerkt overeenkomstig de plaatselijke geldende milieuvorschriften.

De koelvloeistof wordt teruggewonnen voordat het apparaat definitief wordt vernietigd ((EU) Nr 517/2014 art.8).

 Recycling	Recycling Afvalverwerking 
omkasting	staal/epoxideharsen-polyester
wisselaar	aluminium
leidingen/collectoren	koper/aluminium/koolstaal
afvoerinrichting	polyamide
isolatie wisselaar	EPS (gesinterd polystyreen)
isolatie leidingen	synthetisch rubber
compressor	staal/koper/aluminium/olie
condensor	koper/aluminium
koelvloeistof	R513A
kleppen	messing
elektriciteitskabels	koper/PVC

Apparatuur die elektrische componenten bevat, moet apart worden ingezameld met elektrisch en elektronisch afval in overeenstemming met de lokale en huidige wetgeving.



7 Opsporen van storingen

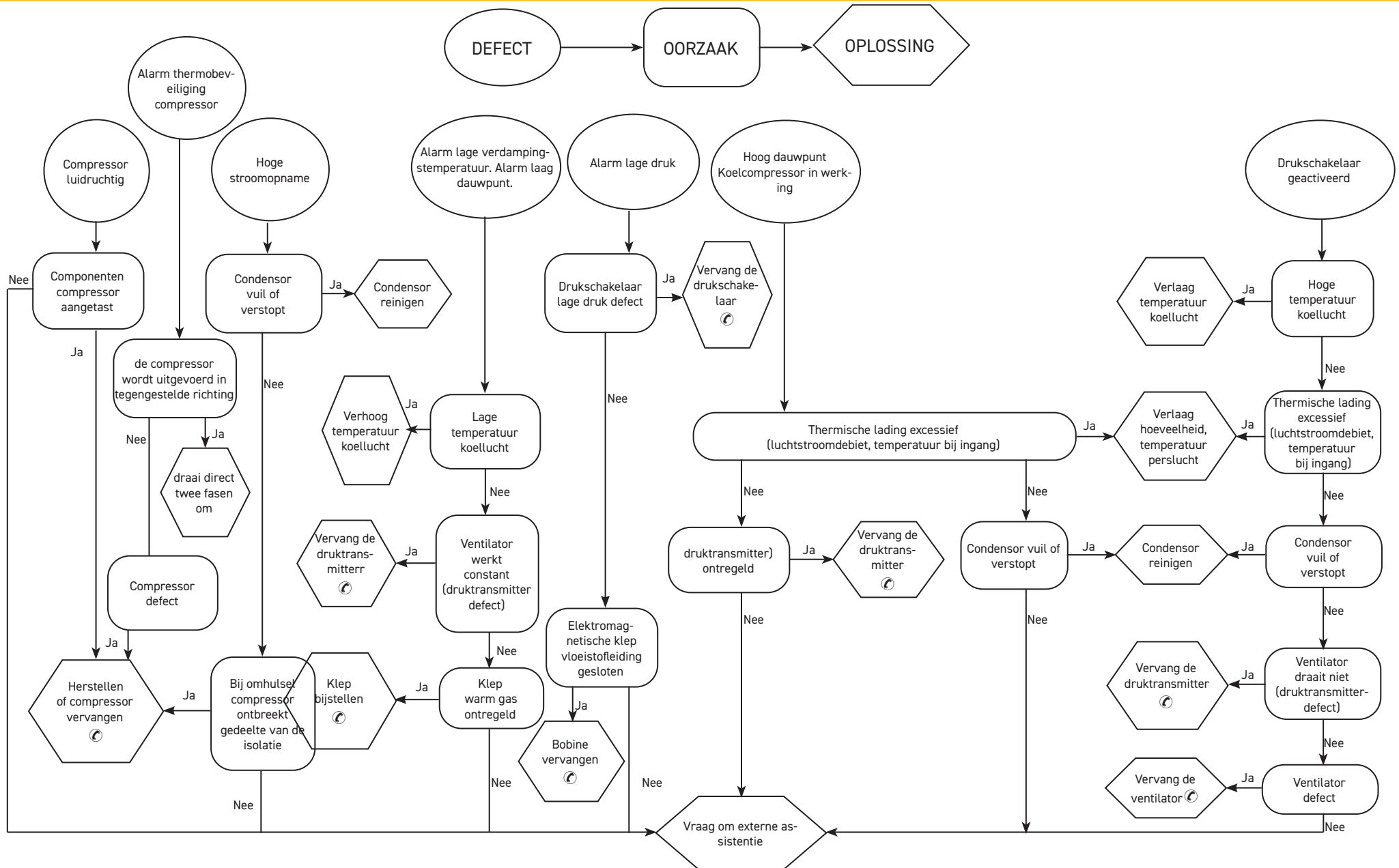

Spis treści

1 Bezpieczeństwo	1
1.1 Istotność instrukcji.....	1
1.2 Sygnalizacja ostrzegawcza.....	1
1.3 Wskazówki dotyczące bezpieczeństwa.....	1
1.4 Ryzyka resztkowe.....	2
2 Wprowadzenie	2
2.1 Transport.....	2
2.2 Przenoszenie.....	2
2.3 Inspekcja.....	2
2.4 Magazynowanie.....	2
3 Instalacja	3
3.1 Sposób instalacji.....	3
3.2 Przestrzeń robocza.....	3
3.3 Wersja kondensator.....	3
3.4 Sugestie.....	3
3.5 Podłączenie elektryczne.....	3
3.6 Podłączenie spustu kondensatu.....	3
4 W trakcie oddawania do użytku	4
4.1 Kontrole wstępne.....	4
4.2 Uruchomienie.....	4
4.3 Praca.....	4
4.4 Zatrzymanie.....	4
5 Sterowanie	5
5.1 Panel sterowania.....	5
5.2 Menu główne.....	5
5.2.1 Machine status (I/O).....	5
5.2.2 Ciśnienie.....	6
5.2.3 Temperatury.....	6
5.2.4 Pobieranie.....	7
5.2.5 Numer seryjny data.....	7
5.2.6 Menu ogólne.....	7
5.2.6.1 Język.....	7
5.2.6.2 Data/Czas.....	7
5.2.6.3 Menu User.....	8
5.2.6.4 Parametr.....	8
5.3 Alarmy/Ostrzeżenia.....	10
5.3.1 Lista alarmów/ostrzeżeń.....	10
5.4 Szybkie menu.....	11
6 Konserwacja	12
6.1 Uwagi ogólne.....	12
6.2 Czynniki chłodniczy.....	12
6.3 Program konserwacji prewencyjnej.....	12
6.4 emontaż.....	13
7 Wyszukiwanie usterek	14
8 Aneks	

1 Bezpieczeństwo

1.1 Istotność instrukcji

- Przechowywać ją przez cały okres eksploatacji maszyny.
- Przeczytać ją przed przystąpieniem do jakichkolwiek czynności.
- Podlega zmianom: w celu aktualizacji informacji, zapoznać się z instrukcją dołączaną do maszyny.

1.2 Sygnalizacja ostrzegawcza



Polecenie w celu wyeliminowania zagrożeń dla osób.



Polecenie, którego należy przestrzegać w celu wyeliminowania ryzyka uszkodzenia urządzenia.









Wymagana obecność upoważnionego, doświadczonego technika.



Podano symbole, których znaczenie jest w paragrafie 8.1

1.3 Wskazówki dotyczące bezpieczeństwa

-  Każde urządzenie wyposażone jest w odłącznik elektryczny umożliwiający przeprowadzenia interwencji w bezpiecznych warunkach. Odłącznika należy używać zawsze do wyeliminowania ryzyka podczas konserwacji.
-  Instrukcja przeznaczona jest dla użytkownika końcowego i dotyczy wyłącznie czynności wykonywanych przy zamkniętych panelach: czynności wymagające ich otwarcia przy pomocy narzędzi mogą być wykonywane przez doświadczony i wykwalifikowany personel.
-  Nie przekraczać ograniczeń projektowych podanych na tabliczce znamionowej.
-   Użytkownik jest zobowiązany nie dopuścić do działania innych obciążeń oprócz wewnętrznego ciśnienia statycznego. W razie zaistnienia niebezpieczeństwa wstrząsów sejsmicznych, należy odpowiednio zabezpieczyć urządzenie.
-  Obowiązkiem użytkownika jest zapewnienie zabezpieczeń na obwodzie sprężonego powietrza.
-  Wymiarowanie zabezpieczeń obwodu sprężonego powietrza należy wykonać z uwzględnieniem parametrów technicznych instalacji oraz obowiązujących miejscowych przepisów. Urządzenia należy używać wyłącznie do zastosowań profesjonalnych i do celu, do którego zostało przeznaczone. Użytkownik ma obowiązek przeanalizowania wszystkich aspektów zastosowania i miejsca instalacji produktu, przestrzegania wszystkich stosownych standardów bezpieczeństwa przemysłowego oraz

wszystkich zaleceń dotyczących produktu zawartych w instrukcji obsługi oraz wszelkiej innej dokumentacji dołączonej do urządzenia.

Przeróbki lub wymiana jakiegokolwiek komponentu przez osoby nieupoważnione i/lub nieprawidłowa obsługa urządzenia powodują unieważnienie gwarancji i zwalniają producenta z jakiegokolwiek odpowiedzialności.

Producent nie ponosi odpowiedzialności teraz ani w przyszłości za szkody doznane przez osoby, mienie i samo urządzenie wynikłe z zaniedbań ze strony operatorów, nieprzestrzegania wskazówek podanych w niniejszej instrukcji oraz niezastosowania obowiązujących norm odnośnie bezpieczeństwa instalacji.

Producent nie ponosi odpowiedzialności za ewentualne szkody wynikłe wskutek zmiany i/lub modyfikacji opakowania.

Użytkownik ma obowiązek upewnić się, że dane techniczne niezbędne do wyboru urządzenia lub jego komponentów i/lub opcji są wyczerpujące w celu zagwarantowania prawidłowej lub przewidywalnej obsługi i eksploatacji samego urządzenia lub jego komponentów.

 **UWAGA: Producent zastrzega sobie prawo do zmiany informacji zawartych w niniejszej instrukcji bez uprzedniego powiadomienia. Aby zawsze uzyskać pełne i aktualne informacje, użytkownik musi skontaktować się z Producentem.**

1.4 Ryzyka resztkowe

Instalacja, uruchomienie, wyłączenie, konserwacja maszyny muszą być kategorię wykonywane zgodnie z dokumentacją techniczną produktu a w każdym razie unikając stworzenia jakiegokolwiek zagrożenia.

Zagrożenia, których nie można było wyeliminować w fazie projektowania, podano w poniższej tabeli.

część maszyny	ryzyko resztkowe	Sposób ekspozycji	środki ostrożności
bateria wymiany termicznej	niewielkie rany cięte	kontakt	unikać kontaktu, używać rękawic ochronnych
kratka wentylatora i wentylator	uszkodzenia	wkładanie ostrych przedmiotów przez kratkę podczas pracy wentylatora	nie wkładać przedmiotów jakiegokolwiek rodzaju do kratki wentylatorów i nie kłaść przedmiotów na kratkach
wnętrze jednostki: sprężarka i rura doprowadzająca	oparzenia	kontakt	unikać kontaktu, używać rękawic ochronnych
wnętrze jednostki: części metalowe i kable elektryczne	zatrucia, porażenie prądem, poważne oparzenia	wada izolacji kabli zasilających przed tablicą elektryczną jednostki części metalowe pod napięciem	ochrona elektryczna odpowiednia do linii zasilającej; maksymalna dbałość przy podłączaniu uziemienia części metalowych
na zewnątrz jednostki: obszar przylegający do jednostki	zatrucia, poważne oparzenia	pożar z powodu krótkiego spęcia lub przegrzania linii zasilającej przed tablicą elektryczną jednostki	przekrój kabli i system osłon elektrycznej linii zasilającej zgodne z obowiązującymi normami

2 Wprowadzenie

Niniejsza instrukcja odnosi się do osuszaczy chłodniczych przeznaczonych do usuwania pary wodnej ze sprężonego powietrza.

2.1 Transport

Zapakowana jednostka musi być:

- w pozycji pionowej;
- chroniona przed wpływem czynników atmosferycznych;
- chroniona przed uderzeniami.

2.2 Przenoszenie

Używać wózka podnośnikowego widłowego dostosowanego do podnoszonego ciężaru, unikając jakichkolwiek uderzeń.

2.3 Inspekcja

- Wszystkie jednostki są montowane, zaopatrywane w przewody, napełniane płynem chłodzącym oraz olejem, a także testowane w standardowych warunkach pracy przez producenta;
- Po odbiorze maszyny sprawdzić jej stan: zgłaszać bezzwłocznie firmie przewoźowej ewentualne uszkodzenia;
- rozpakować jednostkę jak najbliżej miejsca instalacji.

2.4 Magazynowanie

Jeśli konieczne jest ustawianie jednostek jedna na drugiej, postępować według wskazówek na opakowaniu. Przechowywać jednostkę w opakowaniu w miejscu czystym i chronionym przed wilgocią i złymi warunkami atmosferycznymi.

3 Instalacja

Instalować w pomieszczeniu w czystym, suchym miejscu, chronionym przed czynnikami atmosferycznymi, bezpośrednim nasłonecznieniem i / lub innymi trudnymi warunkami.

Zainstalowany produkt musi być odpowiednio zabezpieczony przed zagrożeniem pożarowym (odn. EN378-3).

3.1 Sposób instalacji

W modelach upewnić się, że dokręcono kołki gwintowane w kołnierzach aż do ogranicznika a dopiero potem podłączyć przeciwkołnierze (patrz paragraf 8.6).

Przestrzegać wskazówek zawartych w paragrafach 8.2 i 8.3.

Każdy osuszacz musi być poprzedzony filtrem wstępnym, usytuowanym na wlocie do osuszacza. Dostawca nie ponosi odpowiedzialności za wszelkie uszkodzenia powstałe w wyniku braku zastosowania filtra wstępnego.

Element filtrowania wstępnego (filtrowanie do 3 mikronów lub niżej) należy wymieniać co najmniej raz w roku lub z częstotliwością wskazaną przez producenta.

Przyłączyć osuszacz prawidłowo do złączy wlotowo/wylotowych sprężonego powietrza.

3.2 Przestrzeń robocza

Zostawić przestrzeń 1.5 m wokół jednostki.

Zostawić przestrzeń 2 m nad osuszaczem w przypadku modeli z pionowym wyrzutem powietrza kondensacyjnego.

3.3 Wersja kondensator

Wersja powietrzna (Ac)

Unikać recyrkulacji powietrza chłodzącego. Nie zatykać kratki wentylacyjnych.

Wersja wodna (Wc)

Jeśli nie przewidziano w dostawie, zamontować filtr siatkowy na wejściu wody kondensacyjnej.

Charakterystyki wody kondensacyjnej na wejściu:

Temperatura	≥50°F (10°C)	CL ⁻	<50 ppm
ΔT IN/OUT	5-15°C	CaCO ₃	70-150 ppm
Max % glikol	50	O ₂	<0.1 ppm
Ciśnienie	43.5-145 PSIG (3-10 barg)	Fe	<0.2 ppm
PH	7.5-9	NO ₃	<2 ppm
Przewodność elektryczna	10-500 μS/cm	HCO ₃ ⁻	70-300 ppm
Indeks nasycenia Langeliera	0-1	H ₂ S	<0.05 ppm
SO ₄ ²⁻	<50 ppm	CO ₂	<5 ppm
NH ₃	<1 ppm	Al	<0.2 ppm

W przypadku szczególnego rodzaju wody użytej do chłodzenia (dejonizowana, demineralizowana, destylowana) standardowe materiały przewidziane dla kondensatora mogą okazać się nieodpowiednie. W takich przypadkach zaleca się kontakt z producentem.

3.4 Sugestie

Aby nie uszkodzić komponentów wewnętrznych osuszacza i sprężarki powietrza, unikać instalacji, w której powietrze z otoczenia zawiera zanieczyszczenia stałe i/lub gazowe: uwaga na siarkę, amoniak, chlor i instalacje w okolicach nadmorskich.

Dla wersji z wentylatorami osiowymi nie zaleca się odprowadzania rurami zużytego powietrza.

3.5 Podłączenie elektryczne

Stosować kabel z homologacją zgodnie z lokalnymi przepisami i normami (przekrój minimalny kabla, patrz paragraf 8.3).

Zamontować magnetotermiczny wyłącznik różnicowoprądowy przed instalacją (RCCB - IDn = 0.3A) z odległością styków w stanie otwartym 3 mm (patrz obowiązujące lokalnie przedmiotowe normy).

Nominalny prąd wejściowy („In”) takiego wyłącznika magnetyczno-termicznego musi być równy wartości FLA oraz krzywej zadziałania typu D.

Wybierz zasilacz i włóż mostek, jak pokazano poniżej:

S7-S6 dla 400/3/50

S8-S6 dla 460/3/60

Wewnątrz panelu elektrycznego znajduje się etykieta z instrukcją.

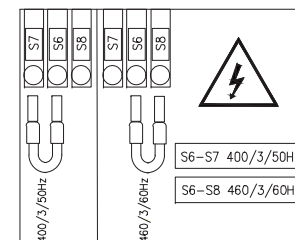

3.6 Podłączenie spustu kondensatu

Wykonać podłączenie do systemu spustowego unikając podłączenia w obwodzie zamkniętym wspólnym z innymi liniami spustowymi pod ciśnieniem. Sprawdzić prawidłowość odpływu spuszczonego kondensatu. Usuwać cały kondensat zgodnie z obowiązującymi lokalnymi przepisami o ochronie środowiska.

4 W trakcie oddawania do użytku

4.1 Kontrole wstępne

Przed oddaniem osuszacza do użytku należy sprawdzić, czy:

- instalacja została przeprowadzona zgodnie z zaleceniami podanymi w rozdziale 3;
- zawory wlotowe powietrza są zamknięte i czy przez osuszacz nie przepływa powietrze;
- zasilanie elektryczne jest odpowiednie;
- w wersji WC - otworzyć obwód wody chłodzącej na kilka minut przed uruchomieniem osuszacza.

4.2 Uruchomienie



1. włączyć zasilanie, obracając PRZEŁĄCZNIK GŁÓWNY

“” w położeniu “I ON” (WŁ.).
pojawiają się te informacje:

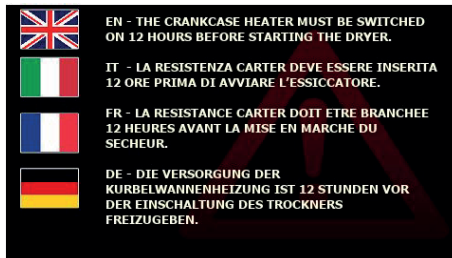
 **GRZAŁKA POWINNA BYĆ ZAŁĄCZONA NA 12 GODZIN PRZED URUCHOMIENIEM OSUSZACZA.**



Następnie dotknij , aby wejść na panelu sterowania.

2. Dotknąć  w celu uruchomienia; przycisk zmieni kolor z szarego na zielony, aby zasignalizować, że osuszacz teraz pracuje .
3. Uruchomić osuszacz przed sprężarką powietrza;
Nieprzestrzeganie tej zasady może spowodować poważne uszkodzenie sprężarki.

 Wentylator (Wersja AC): w przypadku podłączenia z niewłaściwą kolejnością faz obracają się w przeciwnym kierunku, co grozi uszkodzeniem (w tym przypadku powietrze wychodzi z obudowy osuszacza przez kratkę skraplacza zamiast kratki wentylatora - patrz par. 8.6 i 8.7 zawierające informacje dotyczące prawidłowego przepływu powietrza); natychmiast odwrócić dwie fazy.

4. Odczekać 5 minut, a następnie powoli otworzyć zawór wlotu powietrza;
5. Powoli otworzyć zawór wylotu powietrza: osuszacz teraz osusza.

Monitor faz



Monitor faz

Jeżeli na wyświetlaczu pojawi się alarm podczas uruchamiania osuszacza, użytkownik musi sprawdzić okablowanie zacisków wejściowych przetwornika odłączającego osuszacz.

4.3 Praca

- Pozostawić włączony osuszacz przez cały czas, w którym działa sprężarka powietrza;
- Osuszacz pracuje w trybie automatycznym, dlatego nie są wymagane ustawienia w miejscu instalacji;
- W przypadku nieoczekiwanych nadmiernych strumieni powietrza należy wykonać obejście, aby uniknąć przeciążania osuszacza.
- Nie dopuszczać do fluktuacji temperatury wlotu powietrza.

4.4 Zatrzymanie

1. Zatrzymać osuszacz 2 minuty po zatrzymaniu się sprężarki powietrza, a w każdym przypadku po przerwie w przepływie powietrza;
2. upewnić się, czy sprężone powietrze nie wchodzi do osuszacza, gdy osuszacz jest odłączony lub jeżeli włączony jest alarm;
3. Nacisnąć przycisk  aby wyłączyć osuszacz. Przycisk zmieni kolor na szary. 
4. Obrócić PRZEŁĄCZNIK GŁÓWNY “” w położenie “O OFF” (WYŁ.) w celu wyłączenia zasilania.

 Wersja WC - zamknąć obwód wody, gdy osuszacz nie pracuje.

5 Sterowanie

5.1 Panel sterowania

Przyciski dotykowe	Funkcja
	Osuszacz WYł (szary)
	Osuszacz Wł (zielony)

LOCAL = Lokal konfiguracja
REMOTE = op afstand konfigura.

Funkcja	Przyciski dotykowe	Funkcja
 Prędkość pracy wentylatora (jedynie dla Wersja powietrzna)		Dostęp do menu informacji: stan maszyny, ciśnienia, temperatury, ustawienia ogólne, zużycie, hasło użytkownika
 Prędkość pracy zaworu gorącego gazu		Szary= brak alarmy Czerwony = ostrzeżenia Czerwony migająca = alarmy
 Oszczędzanie energii% (Cykl)		Osuszacz OFF = szare światło Cycling aktywne = miga na zielono Kompresor aktywne = niebieskie światło
		szary = Spust kondensatu OFF zielony = Spust kondensatu ON

Funkcja	Przyciski dotykowe	Funkcja
 Wykres punktu ros		Dotknąć: do ręcznego spustu
		Funkcja Strep led: niebieskie = Kompresor aktywne zielony = Oszczędzanie energii Czerwony = alarmy

5.2 Menu główne

Dotknąć w celu wejścia do menu "Informacje". Gdy jeden z „przycisków dotykowych” zostaje dotknięty, przez kilka sekund podświetlany jest jego obrys w celu potwierdzenia, że dokonano wyboru.

Ma to miejsce w przypadku każdego „przycisku dotykowego” występującego na panelu sterowania.

Dotknąć aby powrócić do ekranu głównego.

5.2.1 Machine status (I/O)

Dotknąć w celu wejścia do menu "Stan maszyny". Poniżej przedstawiono listę wejść:

Kontrolka LED obok opisu wskazuje, czy zabezpieczenia / funkcje / konfiguracje są:

- aktywne = zielone światło
- nieaktywne = szare światło

Dotknąć aby wejść na następną stronę.

Poniżej przedstawiono listę wyjść:



Dotknąć aby powrócić do poprzedniego menu.

5.2.2 Ciśnienie



Dotknąć  aby wejść do menu „Ciśnienie” w celu wyświetlenia: ciśnienia skraplania, prędkości obrotowej wentylatora, ciśnienia parowania, prędkości pracy zaworu gorącego gazu.

Dotknij określonego parametru, aby wyświetlić trendy danych dotyczące wydajności w czasie.

“Ciśnienie skraplania/parowania”

użyć strzałek  i  do przewijania wykresu graficznego.

Dotknąć  aby powrócić do poprzedniego menu. “Prędkość pracy zaworu gorącego gazu/wentylatora”

użyć strzałek  i  do przewijania wykresu graficznego.

Dotknąć  aby powrócić do poprzedniego menu.

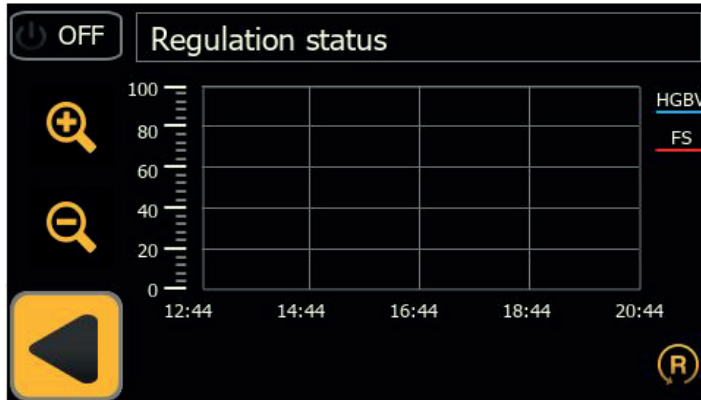
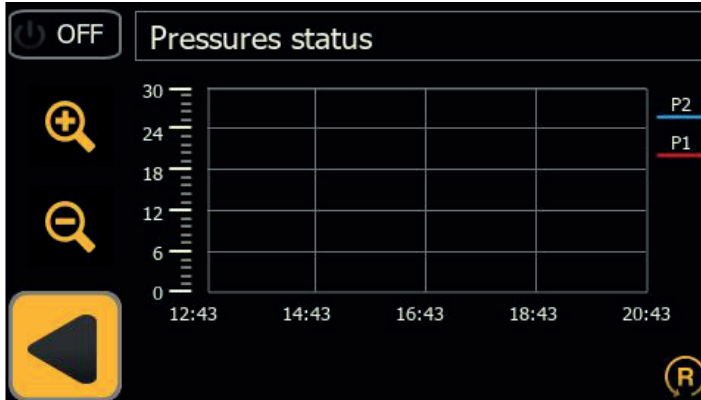
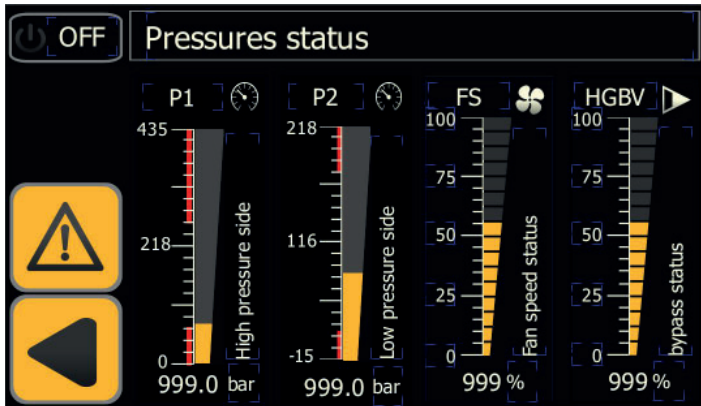

5.2.3 Temperatury

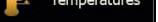
Dotknąć  aby wyświetlić odczyty temperatury sond temperatury na schemacie obwodu.

Dotknąć  aby wejść na następną stronę.

B4 = aktywny tylko dla wersji Multicooler.

Dotknij jednej z wartości temperatur niskiego ciśnienia, aby zobaczyć trend danych dla wszystkich sond w obwodzie niskiego ciśnienia.

Dotknij jednej z wartości temperatury wysokiego ciśnienia, aby zobaczyć trend danych dla wszystkich sond w obwodzie wysokiego ciśnienia.

Temperatury - Strona niskiego ciśnienia

użyć strzałek  i  do przewijania wykresu graficznego.

Dotknąć  aby powrócić do poprzedniego menu.

Temperatury - Strona wysokiego ciśnienia

użyć strzałek  i  do przewijania wykresu graficznego.

Dotknąć  aby powrócić do poprzedniego menu.

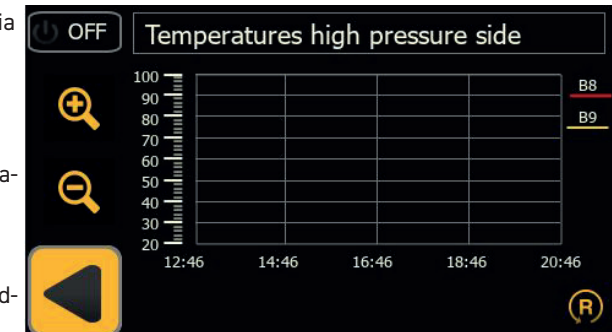
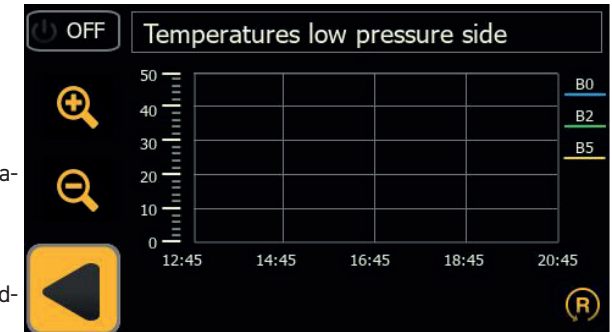
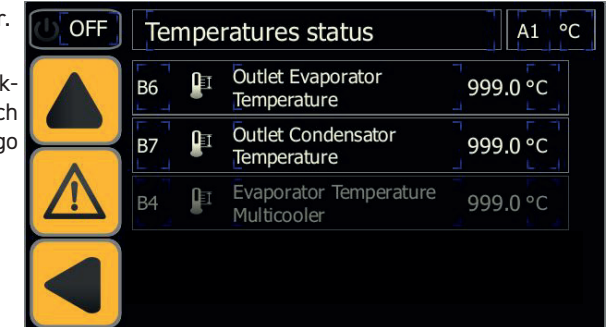
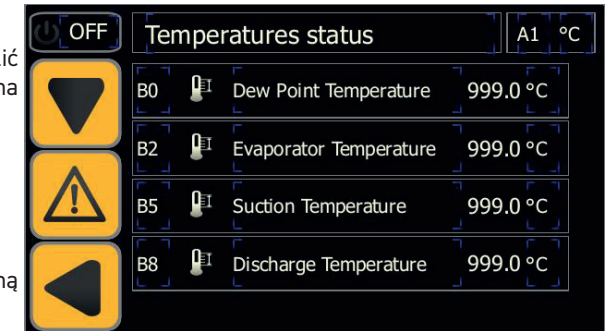

5.2.4 Pobieranie

Użyj USB z diodą LED, która pokazuje fazę pobierania.
(8GB sformatowane jako FAT32) włożyć do panelu przedniego.

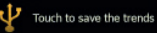
Dotknąć  aby rozpocząć pobieranie.
Czas pobierania danych zależy od ilości zapisanych danych.

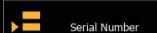

5.2.5 Numer seryjny data

Dotknąć  w celu wejścia do menu „Serial number”.

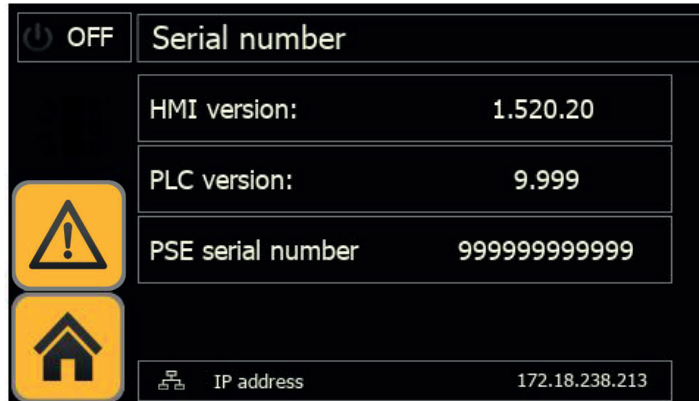

Dotknąć  aby powrócić do ekranu głównego.

5.2.6 Menu ogólne

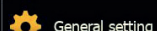
Dotknąć  aby wejść do menu „Ogólnego” z następującymi sekcjami; język, data/godzina, parametry, konserwacja, praca cykliczna/ciągła.

Dotknij dowolnego menu, aby wyświetlić / dostosować.

Dotknąć  aby powrócić do ekranu głównego.

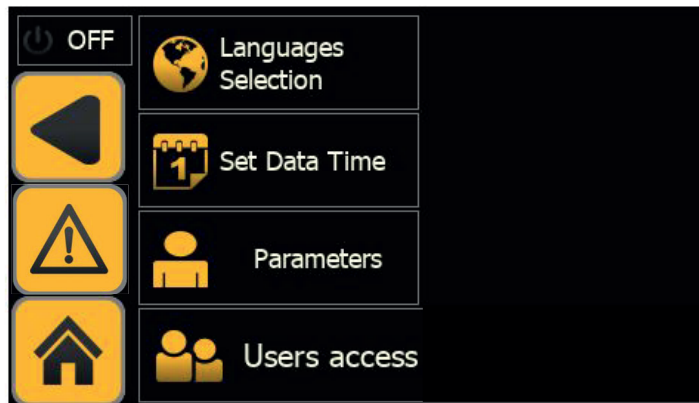

5.2.6.1 Język

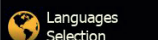
Dotknąć  w celu wejścia do menu języka..
Dotknąć języka, którego się potrzebuje.
Nastąpi automatyczny powrót do menu głównego z wybranym językiem.

Dotknąć  aby powrócić do poprzedniego menu.

Dotknąć języka, którego się potrzebuje.
Nastąpi automatyczny powrót do menu głównego z wybranym językiem.

Dotknąć  aby powrócić do poprzedniego menu.



5.2.6.2 Data/Czas

Dotknąć  w celu wejścia do menu „Data/Czas”.

Dotknąć Data/Czas w sekcji, aby dokonać zmiany.

Naciśnij przez 2 sekundy



aby potwierdzić.

Dotknąć  aby powrócić do poprzedniego menu.

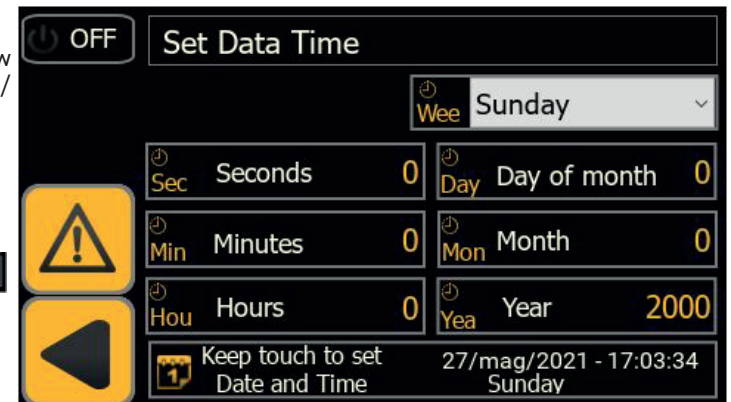

5.2.6.3 Menu User

Dotknąć  Users access  w celu wejścia do menu „User”.



To menu jest zarezerwowane dla technika serwisu firmy Parker.

User name:

Password:

Show password

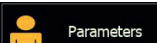

5.2.6.4 Parametr

Dotknąć  Parameters  w celu wejścia do menu „Parametr” z następującymi sekcjami: sondy, spust kondensatu, konfiguracja, konserwacja, cykle





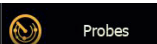



Dotknąć „przycisku dotykowego”, aby wejść do menu.

Dotknąć  aby powrócić do poprzedniego menu.

Sondy

Dotknąć  Probes  aby ustawić ostrzeżenia i opóźnienia lub minimalną/maksymalną wartość punktu rosy.



OFF	Probes	
	A6  Warning high dew point	0.0 °C
	A8  Delay warning high dew point	0'
	A9  Warning low dew point	0.0 °C
	A10  Delay warning low dew point	0 s

Spust kondensatu

Dotknąć  aby wejść do menu „Spust kondensatu”. Ustawić:

1. spust czasowy (wybór czasów zamknięcia i otwarcia);
2. spust pojemnościowy;
3. spust ciągły (spust zewnętrzny).

Dotknąć  aby powrócić do poprzedniego menu.

Konfiguracja

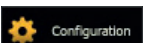
Dotknąć  aby wejść do wyświetlacza konfiguracji z następującym menu:

1. Wybór stopni temperatury - °C/ °F;
2. Włączenie zdalnego sterowania;
3. Włączenie samych alarmów lub alarmów / ostrzeżeń;
4. Reset ustawień i przywrócenie parametrów domyślnych.

Użyć „przycisku dotykowego” w pobliżu opisu, aby dokonać wyboru.

 Aby zarządzać trybem REMOTE OFF, usuń mostek między zaciskami: 87 -GND i podłącz zdalny przełącznik start/stop (dostarczony przez klienta).

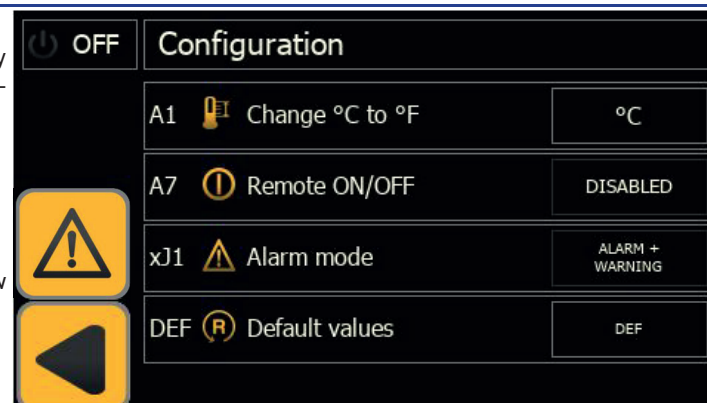
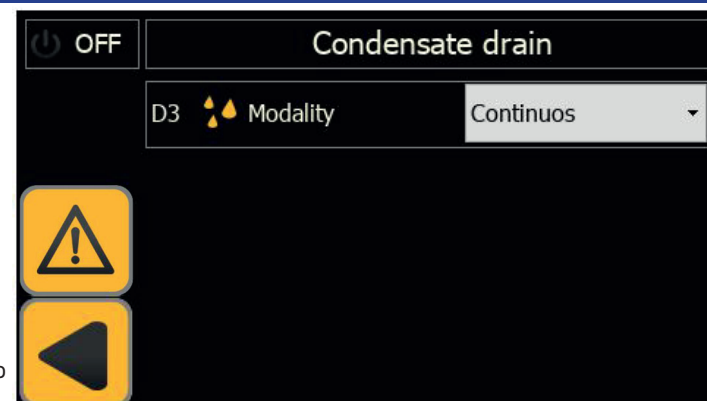

Konserwacja

Dotknąć  aby wyświetlić godziny pracy sprężarki/osuszacza.

Dotknąć  aby powrócić do poprzedniego menu.

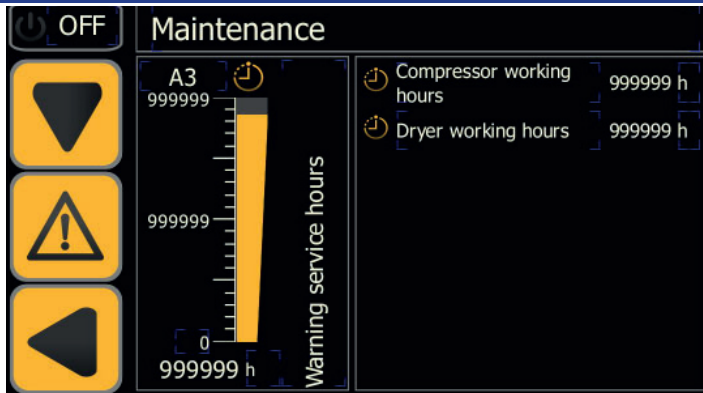

Praca

Dotknąć  aby wybrać tryb pracy: ciągły lub cykliczny (energooszczędny).

Użyć „przycisku dotykowego” w pobliżu opisu, aby dokonać wyboru.

Dotknąć  aby powrócić do poprzedniego menu.

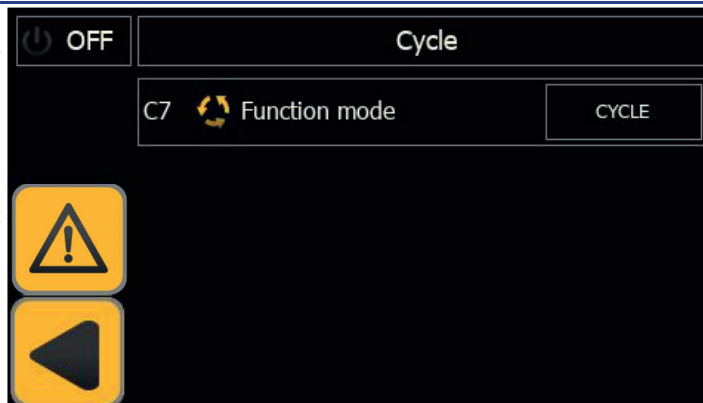

Modbus

Dotknąć  aby ustawić parametry Modbus. MODBUS RTU (RS485)

Dotknąć  aby wejść na na następną stronę. MODBUS TCP/IP

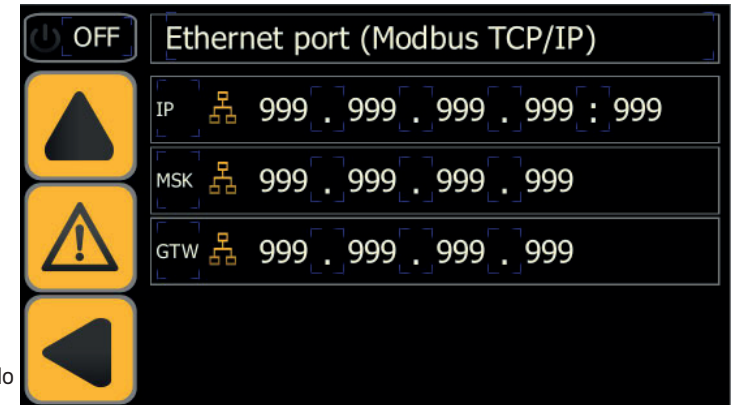
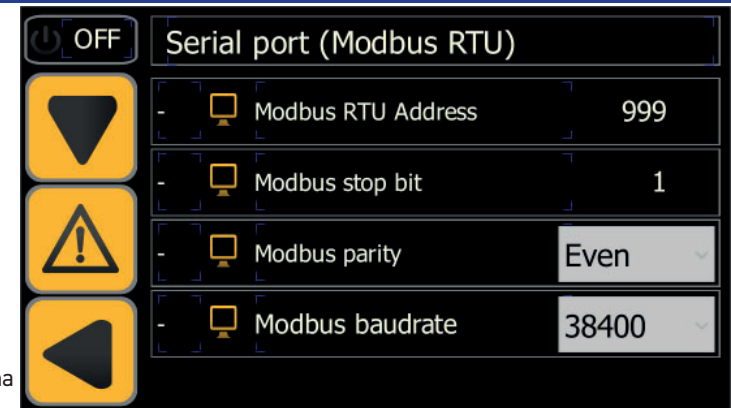

Dotknąć  aby powrócić do poprzedniego menu.

Wyłączyć/włączyć osuszacz, aby potwierdzić konfigurację.

Cloud

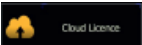
Dotknąć  aby zobaczyć „Password” do Cloud.

Ta opcja jest w toku.

Dotknąć  aby powrócić do poprzedniego menu.



5.3 Alarmy/Ostrzeżenia

Dotknąć  w celu wejścia do menu „Alarmy/Ostrzeżenia”.

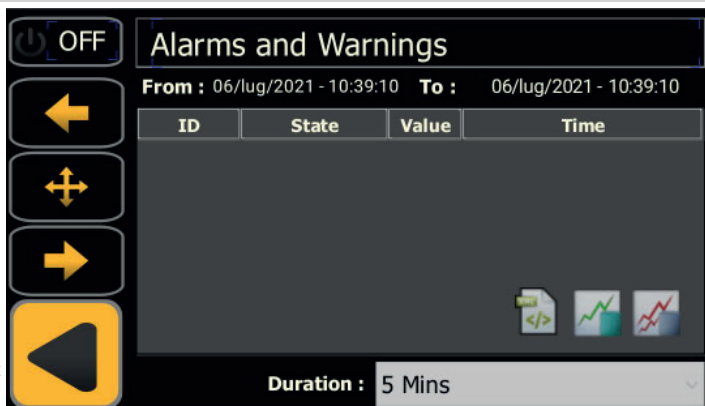

Dotknij „Duration”, aby zmienić czas badania.

Po przywróceniu nominalnych warunków pracy niektóre ostrzeżenia i alarmy są automatycznie resetowane, w przypadku innych alarmów/ostrzeżeń konieczne jest wykonanie resetu ręcznego.

Dotknąć  w celu zresetowania alarmu.

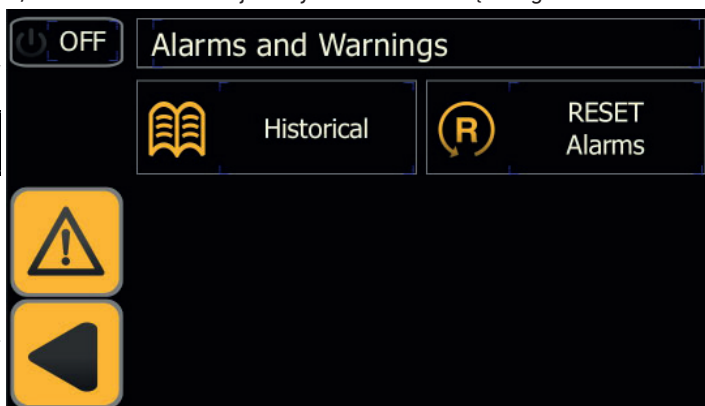

Dotknąć  w celu wyświetlenia historii alarmów z:

kodem alarmu, datą, liczbą alarmów, pozycją w kolejności występowania i godziną aktywacji alarmu.

Dotknąć  aby powrócić do poprzedniego menu.

5.3.1 Lista alarmów/ostrzeżeń

a = alarm; w = Ostrzeżenie.

Code	Alarm/Ostrzeżenie	Przyczyna
aLD	Alarm Niski Punkt Rosy	temperaturą B0<A9 za więcej niż A10 sekundy.
aLT	Alarm niskiej temperatury parownika	temperaturą B2<A12 za więcej niż A13 sekundy
aHT2	alarm przed wysoką temperaturą rozładowania	temperaturą B8>A11
aHP	Alarm Wysokie Cisnienie	Przełącznik wysokiego ciśnienia czynny
aLP	Alarm Niskie Cisnienie	Przełącznik niskiego ciśnienia czynny
aLTA	Alarm Niska temperaturą multicooter	temperaturą B4<A12 za więcej niż A13 sekundy
aPI*	Alarm Termiczny Sprezarki	Termiczny Sprezarki czynny
aPH	Alarm Monitor fazy	Monitor fazy czynny (dla 460-750)
aCM1	Alarm Komunikacja ekspansja 1	ekspansja 1 nie komunikuje
aCM2	Alarm Komunikacja ekspansja 2	ekspansja 2 nie komunikuje
wB0	Ostrzeżenie sonda B0	sonda uszkodzona lub niepodłączona
wB2	Ostrzeżenie sonda B2	sonda uszkodzona lub niepodłączona
wB4	Ostrzeżenie sonda B4	sonda uszkodzona lub niepodłączona
wB5	Ostrzeżenie sonda B5	sonda uszkodzona lub niepodłączona
wB6	Ostrzeżenie sonda B6	sonda uszkodzona lub niepodłączona
wB8	Ostrzeżenie sonda B8	sonda uszkodzona lub niepodłączona
aFP1	Alarm wysokiego ciśnienia Převodník P1	Převodník uszkodzona lub niepodłączona
wHD	Ostrzeżenie Niski Punkt Rosy	temperaturą B0>A6 za więcej niż A8 minuty
wHT1	Ostrzeżenie przed wysoką temperaturą rozładowania	temperaturą B8>A14 for more than A15 minuty
wHP1	Ostrzeżenie Wysokie Cisnienie	ciśnienia P1>A16 za więcej niż 2 sekundy
wHB5	Ostrzeżenie przed wysoką temperaturą ssania	temperaturą B5>A18 za więcej niż 1 minuty
wLP2	Ostrzeżenie Niskie Cisnienie	ciśnienia P2<A21 za więcej niż 150 sekundy
wSR	Ostrzeżenie Konserwacja planowa	uptynął czas usługi
wDR1	Ostrzeżenie Spust kondensatu 1	kondensat nie jest odprowadzany cooler 1
wDR2	Ostrzeżenie Spust kondensatu 2	kondensat nie jest odprowadzany cooler 2
wDR3	Ostrzeżenie Spust kondensatu 3	kondensat nie jest odprowadzany cooler 3
aFP2	Alarm niskiego ciśnienia Převodník P2	Převodník uszkodzona lub niepodłączona

* dla modeli 900-1800 alarm może mieć również znaczenie odwróconych faz.

5.4 Szybkie menu

Do menu można uzyskać szybki dostęp w krótkich krokach:

Wyświetlanie temperatury

Dotknąć  → Dotknąć  Dotknąć temperatury w celu wyświetlenia wykresów.

Wyświetlanie ciśnienia

Dotknąć  → Dotknąć  Dotknąć ciśnienia w celu wyświetlenia wykresów.

Pobieranie

Dotknąć  → Dotknąć  w celu rozpoczęcia pobierania.

Numer seryjny data

Dotknąć  → Dotknąć  .

Zmiana języka

Dotknąć  → Dotknąć  → Dotknąć  Wybrać swój język.



Data/Czas

Dotknąć  → Dotknąć  → Dotknąć  Aktualizacja zegara

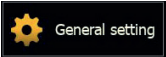
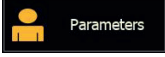
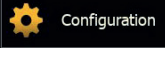
Zmiana jednostki miary z °C na °F, op afstand, DEF

Touch  → Dotknąć  → Dotknąć  → Dotknąć  :
Aby dokonać zmiany, dotknij parametru „°C” lub „°F”.
Włącz/wyłącz parametr „Remote ON/OFF”.
Dotknąć „DEF”, aby przywrócić parametr..

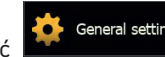
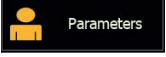
Przełączanie na pracę „cykliczną”

Dotknąć  → Dotknąć  → Dotknąć  → Dotknąć  Cycle
change the operation.

Drain

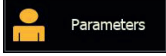
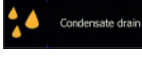
Dotknąć  → Dotknąć  → Dotknąć  → Dotknąć  Condensate drain
Zmienić tryb pracy.

Modbus

Dotknąć  → Dotknąć  → Dotknąć  → Dotknąć  Communication setting

Ustawianie parametrów

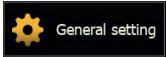
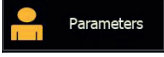
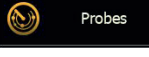
Dotknąć  → Dotknąć  General setting → Dotknąć  Parameters → Dotknąć  Probes
zmienić parametr.

Alarm / Ostrzeżenie

Dotknąć  → Dotknąć  aby znaleźć alarm historyczny i zresetować alarm.

Dotknąć  Historical aby zobaczyć swój historyczny alarm.

Dotknąć  RESET Alarms aby zresetować alarm.

6 Konserwacja

• Urządzenie zostało zaprojektowane w celu zapewnienia pracy ciągłej, jednak jego trwałość eksploatacyjna zależy od wykonywania zalecanej konserwacji.

-  Zwracając się o wsparcie techniczne lub zamawiając części zamienne, należy określić dane urządzenia (model i numer seryjny), odczytując je z tabliczki znamionowej.
- Szczelność obwodów zawierających 5t < xx < 50t CO2 się co najmniej raz w roku. Szczelność obwodów zawierających 50t < xx < 500t CO2 się co najmniej raz na 6 miesięcy. ((UE) Nr. 517/2014 art. 4.3.a, 4.3.b).
- W przypadku urządzeń zawierających 5t CO2 lub więcej, operator musi prowadzić rejestr, w którym określa się ilość i typ stosowanego czynnika chłodniczego, dodawane ilości oraz ilości odzyskane w czasie konserwacji, remontów i złomowania ((UE) Nr. 517/2014 art. 6).

6.1 Uwagi ogólne

 Przed przystąpieniem do jakichkolwiek czynności konserwacyjnych sprawdzić, czy:

- w obwodzie pneumatycznym nie ma już ciśnienia;
- osuszacz jest odłączony od sieci.

 Zawsze stosować oryginalne części zamienne producenta: pod groźbą zwolnienia producenta z wszelkiej odpowiedzialności za nieprawidłowe funkcjonowanie maszyny.

 W przypadku wycieku czynnika chłodniczego skontaktować się z upoważnionym fachowcem.

 Zaworu Schradera można używać tylko w przypadku nieprawidłowego funkcjonowania maszyny: w przeciwnym przypadku szkody spowodowane nieprawidłowym ładunkiem czynnika chłodniczego nie będą uwzględnione przez gwarancję.

6.2 Czynniki chłodniczy

Uzupelnianie płynu chłodzącego: szkody powstałe w związku z błędnym uzupełnieniem płynu chłodzącego przez osoby nieupoważnione nie są objęte gwarancją. 

 Aparatura zawiera fluorowane gazy cieplarniane.

Płyn chłodniczy R513A przy normalnej temperaturze i ciśnieniu jest gazem bezbarwnym należącym do SAFETY GROUP A1 - EN378 (ciecz grupy 2 według dyrektywy PED 2014/68/EU); GWP (Global Warming Potential) = 573.

 W razie wycieku czynnika chłodniczego przewietrzyć pomieszczenie.

6.3 Program konserwacji prewencyjnej

Aby zagwarantować długotrwałą maksymalną wydajność i bezawaryjność osuszacza, należy wykonywać:

Opis czynności konserwacji	Częstotliwość konserwacji (w standardowych warunkach pracy)				
	Czynność	Codziennie	Co tydzień	Co 4 miesiące	Co 12 miesięcy
sprawdzić  serwis 					
Sprawdzić, czy kontrolka zasilania (POWER ON) jest włączona.					
Sprawdzić wskaźniki na panelu sterowania.					
Oczyścić filtr zaworu presostatycznego wody, jeśli nie jest zabrudzony, zwiększyć częstotliwość przeglądów (patrz instrukcja) (PSE750-1800)					
Sprawdzić zawór kondensatu.					
Oczyścić żeberka kondensatora.					
Sprawdzić prawidłowe położenie grzałki karteru.					
Sprawdzić wchłanianie elektryczne.					
Sprawdzić wycieki płynu chłodzącego.					
Rozszczelnić instalację. Przeprowadzić konserwację zaworu.					
Rozszczelnić instalację. Wymienić elementy filtrów wstępnych i końcowych.					
Sprawdzić sondy temperatury. Wymienić w razie konieczności.				 	
Zestaw do konserwacji suszarki.					



Dostępne są (patrz paragraf 8.4):

- Zestawy trzyletniej konserwacji zapobiegawczej;
- Zestawy serwisowe:
 - zestawy sprężarki;
 - zestawy wentylatora;
 - zestawy zaworu gazów gorących;
 - zestawy skraplacza wody.
- indywidualne części zamienne.

6.4 emontaż

Płyn chłodniczy i olej do smarowania zawarte w obwodzie należy usuwać zgodnie z obowiązującymi lokalnymi normami z zakresu ochrony środowiska.

Odzysk chłodziwa ciekłego następuje przed utylizacją końcową urządzenia ((UE) Nr. 517/2014 art.8).

	Recycling Złomowanie 
konstrukcja	stal/żywice epoksydowo-poliestrowe
wymiennik	aluminium
rury/kolektory	miedz/aluminium/stal węglowa
urządzenie spustowe	polyamide
izolacja wymiennika	EPS (polistyren spieniany)
izolacja rur	guma syntetyczna
sprężarka	stal/miedz/aluminium/olej
kondensator	miedz/aluminium
czynnik chłodniczy	R513A
zawory	mosiadz
kable elektryczne	miedz/PCV

Sprzęt zawierający elementy elektryczne należy utylizować oddzielnie wraz z odpadami elektrycznymi i elektronicznymi, zgodnie z lokalnymi i aktualnie obowiązującymi przepisami.



7 Wyszukiwanie usterek

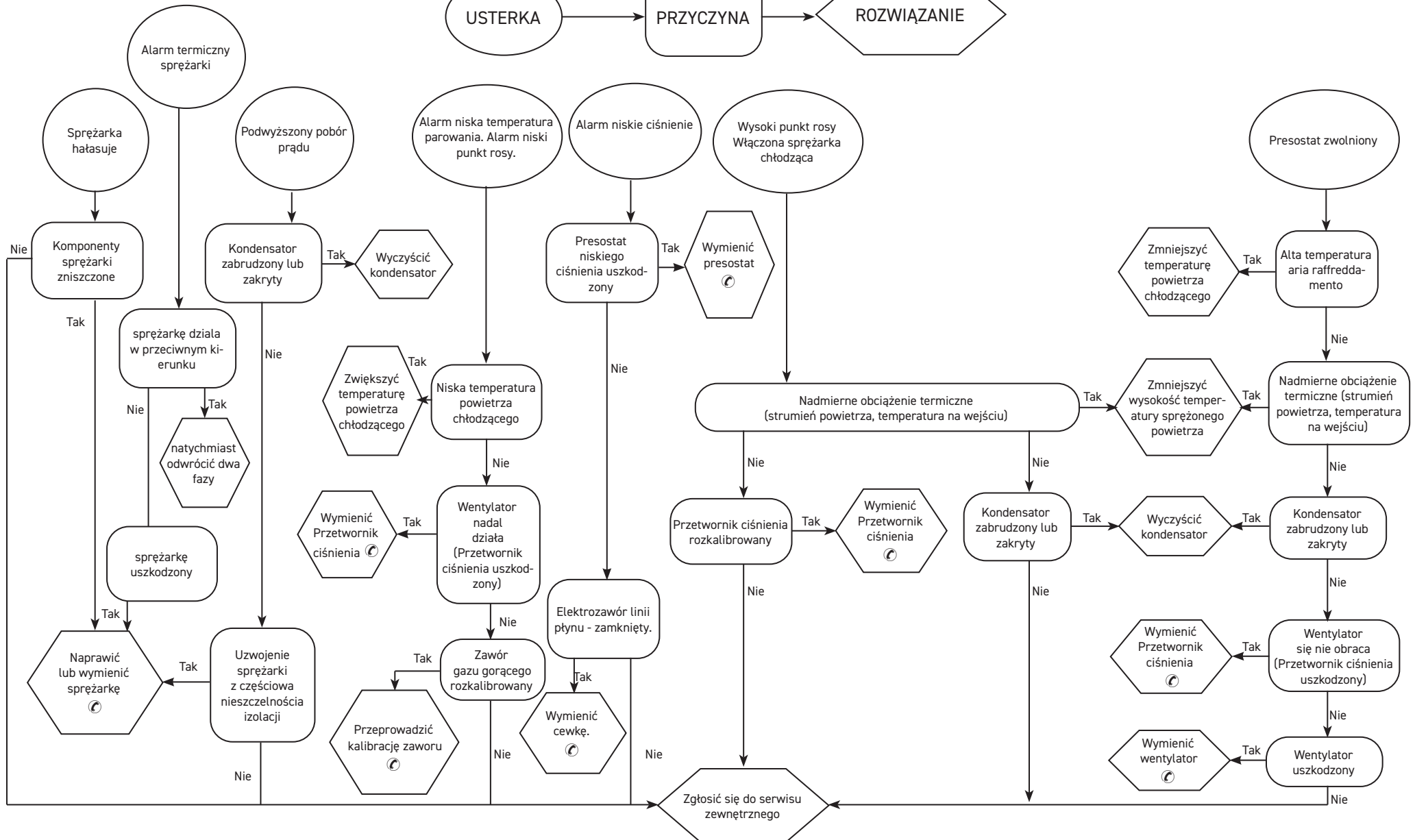

1 Bezpečnost	1
1.1 Význam příručky.....	1
1.2 Výstražné signály.....	1
1.3 Bezpečnostní pokyny.....	1
1.4 Zbytková nebezpečí.....	2
2 Úvod	2
2.1 Přeprava.....	2
2.2 Manipulace.....	2
2.3 Kontrola.....	2
2.4 Uskladnění.....	2
3 Instalace	3
3.1 Podmínky.....	3
3.2 Provozní prostor.....	3
3.3 Kondenzátor Verze.....	3
3.4 Doporučení.....	3
3.5 Připojení k elektrické síti.....	3
3.6 Připojení odvodu kondenzátu.....	3
4 Uvedení do provozu	4
4.1 Předběžné kontroly.....	4
4.2 Spouštění.....	4
4.3 Provoz.....	4
4.4 Zastavení.....	4
5 Ovládání	5
5.1 Ovládací panel.....	5
5.2 Hlavní nabídka.....	5
5.2.1 Stav stroje (I/O).....	5
5.2.2 Tlak.....	6
5.2.3 Teplota.....	6
5.2.4 Stahování.....	7
5.2.5 Údaje o sériovém čísle.....	7
5.2.6 Obecné pokyny.....	7
5.2.6.1 Jazyk.....	7
5.2.6.2 Datum/čas.....	7
5.2.6.3 Nabídky User.....	8
5.2.6.4 Parametr.....	8
5.3 Alarmy/Varování.....	10
5.3.1 Seznam poplachů/upozornění.....	10
5.4 Rychlá nabídka.....	11
6 Údržba	12
6.1 Všeobecná upozornění.....	12
6.2 Chladivo.....	12
6.3 Program preventivní údržby.....	12
6.4 Likvidace.....	13
7 Jak odstranit poruchu	14
8 Příloha	

1 Bezpečnost

1.1 Význam příručky

- Tuto příručku byste měli uchovat po celou dobu životnosti stroje.
- Před jakýmkoli zákrokem na jednotce si příručku pozorně přečtěte.
- Příručka může být změněna: aktualizované informace najdete ve verzi, kterou je stroj vybaven

1.2 Výstražné signály



Příkaz, který brání vzniku nebezpečné situace pro osoby.



Příkaz, kterým brání poškození přístroje.





Nutná přítomnost zkušeného a autorizovaného technika.





Jsou uvedeny symboly, jejichž význam je v části 8.1

1.3 Bezpečnostní pokyny

 Každý stroj je vybaven elektrickým úsekovým vypínačem, kterým je možné bezpečně zasáhnout. Toto zařízení se musí vždy používat k odstranění nebezpečí během údržby..

 Příručka je určena konečnému uživateli pouze pro postupy proveditelné na uzavřených panelech: postupy, které vyžadují jejich otevření pomocí nástrojů smějí provádět pouze odborně vyškolení pracovníci.

 Nepřekračujte limity projektu uvedené na typovém štítku.

  Uživatel nesmí připustit zatížení odlišné od vnitřního statického tlaku. Jestliže hrozí nebezpečí seismické činnosti, musí být stroj vhodně chráněn.

 Bezpečnostní systémy na okruhu stlačeného vzduchu musí zajistit uživatel.

 Dimenzování bezpečnostních zařízení v okruhu stlačeného vzduchu se provádí s ohledem na technické vlastnosti zařízení a na místně platné právní předpisy.

Používejte stroj výhradně k profesionálnímu použití a k účelu, ke kterému byl zkonstruován. Úkolem uživatele je zhodnotit všechny aspekty aplikace, ve které je přístroj instalován, dodržovat všechny průmyslové bezpečnostní normy týkající se stroje a uvedené v příručce k použití a v každé dokumentaci přiložené ke stroji.

Výrobce neodpovídá za porušení nebo výměnu jakéhokoli dílu neautorizovanými pracovníky a/nebo nevhodné použití stroje a tyto postupy mají za následek propadnutí záruky.

Výrobce odmítá jakoukoli nynější i budoucí odpovědnost za zranění osob, škody na věcech a poškození stroje, ke kterým došlo nedbalostí obsluhy, nedodržováním všech pokynů uvedených v této příručce, a nedodržováním platných norem týkajících se bezpečnosti zařízení.

Výrobce nepřijímá odpovědnost za případné škody způsobené poškozením a/nebo úpravami obalu.

Odpovědností uživatele je ověřit, zda jsou specifikace dodané pro zvolený stroj nebo jeho díly anebo volitelné vybavení úplně k účelu správného nebo rozumně předvídatelného používání daného stroje nebo jeho dílů.

 **Výrobce si vyhrazuje právo na změnu údajů uvedených v této příručce bez předchozího upozornění. Nejkomplexnější a nejaktuálnější informace se uživateli doporučuje konzultovat s výrobcem**

1.4 Zbytková nebezpečí

Instalaci, spuštění, vypnutí a údržbu stroje je povoleno provádět pouze v souladu s údaji uvedenými v technické dokumentaci výrobku a vždy tak, aby nedošlo ke vzniku nebezpečné situace. Nebezpečí, která nebylo možné odstranit ve fázi projektu, jsou uvedena v následující tabulce.

dotyčný díl	zbytkové nebezpečí	podmínky	bezpečnostní upozornění
baterie výměny tepla	malá řezná poranění	kontakt	zabraňte kontaktu, používejte ochranné rukavice
mřížka ventilátoru a ventilátor	úrazy	zasunování špičatých předmětů mřížkou při zapnutém ventilátoru	do mřížky ventilátorů nezasunujte žádné předměty, na mřížky nepokládejte žádné předměty
vnitřek jednotky: kompresor a výtlačná trubka	popáleniny	kontakt	zabraňte kontaktu, používejte ochranné rukavice
vnitřek jednotky: kovové díly a elektrické kabely	otrava, zasaení elektr. proudem, váné popáleniny	závada izolace napájecích kabelů před elektrickou deskou jednotky. Kovové díly pod napětím	elektrická ochrana odpovídající vedení napájení. Maximální pečlivost při uzemňování kovových dílů.
vnější část jednotky: zóna okolo jednotky	otrava, váné popáleniny	poár z důvodu zkratu nebo přehřátí napájecího vedení před elektrickou deskou jednotky	část kabelů a systém jištění napájecího vedení v souladu s platnými normami

2 Úvod

Tato příručka se týká chladicích sušiček určených k odstraňování vodní páry ze stlačeného vzduchu.

2.1 Přeprava

Zabalená jednotka musí zůstat:

- ve svislé poloze;
- chráněna před povětrnostními vlivy;
- chráněna před nárazy.

2.2 Manipulace

Použijte vysokozdvizný vozík s vidlicemi, který odpovídá zdvihané váze, vyhněte se jakémukoli nárazu.

2.3 Kontrola

- V továrně jsou všechny jednotky sestaveny, vybaveny kabely, naplněny chladivem a olejem a přezkoušeny ve standardních pracovních podmínkách;
- po přijetí stroje zkontrolujte jeho stav: všechna případná poškození ihned nahlaste dopravci;
- jednotku vybalte co nejdříve instalačnímu místu.

2.4 Uskladnění

Jestliže je nutné skladovat na sobě více jednotek, řiďte se pokyny uvedenými na obalu. Zabalenou jednotku skladujte na čistém místě chráněném před vlhkostí a nepříznivým počasím.

3 Instalace

☞ Instalujte uvnitř místnosti na čistém a suchém místě chráněném před povětrnostními vlivy, přímým slunečním zářením a / nebo jinými drsnými podmínkami.

⚠ Instalovaný produkt musí být vhodně chráněn proti riziku požáru (viz EN378-3)

3.1 Podmínky

⚠ Zašroubujte před připojením protipřírub stavěcí šrouby se zářezem až nadoraz (viz část 8.6).

☞ Dodržujte pokyny uvedené v částech 8.2. a 8.3.
Všechny sušiče musejí být vybaveny odpovídající vstupní filtrací blízko vstupu vzduchu do sušiče. Prodávající nezodpovídá žádným způsobem za jakékoli přímé či nepřímé škody způsobené absencí vstupní filtrace.

☞ Předfiltrací díl (pro filtraci do 3 mikronů nebo méně) se musí vyměnit alespoň jednou ročně nebo v intervalu uvedeném výrobcem.

☞ Sušič připojte správně k přípojkám vstupu/výstupu stlačeného vzduchu.

☞ Correctly connect the dryer to the compressed air inlet/outlet connections.

3.2 Provozní prostor

☞ Okolo jednotky ponechte prostor 1.5 metru.
U modelů s vertikálním vylučováním kondenzovaného vzduchu ponechte nad sušičem prostor 2 metry.

3.3 Kondenzátor Verze

Vzduchová verze (Ac)

Chladicí vzduch nesmí recirkulovat. Nezakrývejte větrací otvory.

Vodní verze (Wc)

Pokud není síťový filtr již instalován, instalujte ho na vstupu kondenzátu.

☞  Vlastnosti kondenzátu na vstupu:

Teplota	≥50°F (10°C)	CL	<50 ppm
ΔT IN/OUT	5-15°C	CaCO ₃	70-150 ppm
Max % glykolu	50	O ₂	<0.1 ppm
Tlak	43.5-145 PSig (3-10 barg)	Fe	<0.2 ppm
PH	7.5-9	NO ₃	<2 ppm
Měrná elektrická vodivost	10-500 μS/cm	HCO ₃ ⁻	70-300 ppm
Langelierův index nasycení	0-1	H ₂ S	<0.05 ppm
SO ₄ ²⁻	<50 ppm	CO ₂	<5 ppm
NH ₃	<1 ppm	Al	<0.2 ppm

Standard materiály určené pro kondenzátor by mohly být nevhodné u speciálních druhů chladicí vody

(ionizovaná, destilovaná, demineralizovaná). V těchto případech je třeba kontaktovat výrobce.

3.4 Doporučení

Sušič ani vzduchový kompresor neinstalujte v prostředí, kde vzduch obsahuje pevné a/nebo plynné nečistoty, protože by mohly poškodit jejich vnitřní součásti: dávejte pozor na síru, čpavek a chlór a instalace v mořském prostředí.

Pro provedení axiální ventilátory doporučujeme provedení kanalizace na použitý vzduch.

3.5 Připojení k elektrické síti

Použijte homologovaný kabel odpovídající zákonným ustanovením a platným místním předpisům (minimální průřez kabelu viz část 9.3). Před systém instalujte tepelně-magnetický diferenciální spínač (RCCB - IDn = 0,3 A) se vzdáleností mezi kontakty při otevření 3 mm (viz příslušné místní platné normy).

Jmenovitý proud "In" tohoto magnetotermického spínače se musí rovnat FLA a vypínací křivce typu D.

Vyberte napájecí zdroj a vložte můstek, jak je znázorněno níže :

S7-S6 za 400/3/50

S8-S6 za 460/3/60

Uvnitř elektrického panelu je štítek s pokyny.

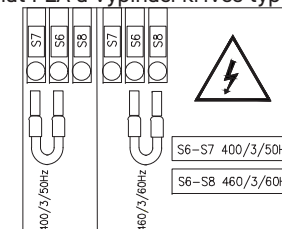

3.6 Připojení odvodu kondenzátu

☞ Provedte připojení k systému odvodu a vyhněte se připojení v uzavřeném okruhu spolu s dalšími tlakovými vedeními. Kontrolujte správný odtok odvodu kondenzátu. Veškerý kondenzát zlikvidujte v souladu s místními platnými normami o životním prostředí.

4 Uvedení do provozu

4.1 Předběžné kontroly

Před spuštěním sušičky zkontrolujte, zda:

- instalace byla provedena v souladu s pokyny uvedenými v části 3;
- jsou ventily přívodu vzduchu zavřené a sušičkou neproudí žádný vzduch;
- jsou správné hodnoty napájení.
- u verze Wc otevřete okruh chladicí vody několik minut před spuštěním sušičky.

4.2 Spouštění

1. zapněte napájení otočením HLAVNÍHO SPÍNAČE“



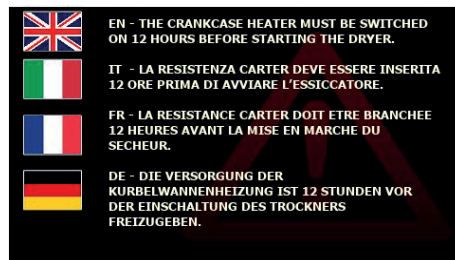

na "I ON": sušička je napájena;
zobrazí se tato informace:

 **TOPENÍ VANY KLIKOVÉ SKŘÍŇE MUSÍ BÝT ZAPOJENO 12 HODIN PŘED SPUŠTĚNÍM SUŠIČE.**



Poté stiskněte pro vstup na ovládacím panelu.

2. Stiskněte  ke spuštění; tlačítko změní barvu ze šedé na zelenou, aby signalizovalo, že sušička je nyní v provozu 
3. Spusťte sušičku ještě před vzduchovým kompresorem;
Nedodržení tohoto pravidla může způsobit vážné poškození kompresoru.

 Ventilátory (Ac verze): Při připojení se špatným sledem fází se ventilátory otáčejí opačným směrem s rizikem poškození (v tomto případě vzduch vychází ze skříně sušičky z mřížek kondenzátoru místo z mřížky ventilátoru - viz odst. 8.6 a 8.7 pro správné proudění vzduchu); okamžitě obraťte dvě fáze.

4. Počkejte 5 minut a poté pomalu otevřete ventil přívodu vzduchu;
5. pomalu otevřete ventil výstupu vzduchu: sušička nyní suší.



Fázový monitor

Pokud se na displeji zobrazí výstraha „Fázový monitor“, musí uživatel během spouštění sušičky ověřit zapojení vstupních svorek odpojovacího spínače sušičky.

4.3 Provoz

- Nechte sušičku zapnutou během celé provozní doby kompresoru.
- Sušička pracuje v automatickém režimu, a proto žádná nastavení na místě nejsou nutná.
- Pokud dochází k nadměrným a neočekávaným proudům vzduchu, proveďte obtok, aby se sušička nepřetížila.
- Vyvarujte se kolísání teploty na vstupu vzduchu.

4.4 Zastavení

1. Zastavte sušičku 2 minuty poté, co se zastaví vzduchový kompresor, nebo v každém případě po přerušení proudu vzduchu;
2. ujistěte se, že do sušičky neproudí stlačený vzduch, když je sušička odpojená nebo dojde k alarmu.
3. Stiskněte  k vypnutí sušičky. Tlačítko změní barvu na šedou. 
4. Otočte HLAVNÍ SPÍNAČ“  na "O OFF "pro vypnutí napájení.

 Verze Wc, uzavřete vodní okruh se zastavenou sušičkou.

5 Ovládání

5.1 Ovládací panel

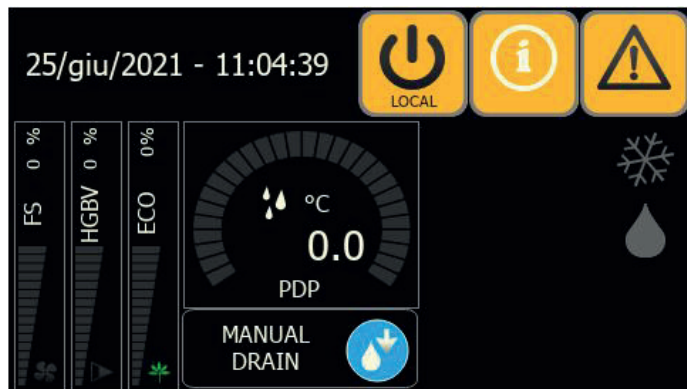

Dotyková tlačítka	Funkce
	Sušička OFF (šedá)
	Sušička ON (zelená)
LOCAL = lokální konfigurace REMOTE = Dálkové konfigurace	

Funkce
FS 48 % Provozní rychlost ventilátoru (pouze pro verzi s kondenzátorem vzduchu)
HGBV 14 % Provozní rychlost ventilu horkého plynu
ECO 0 % Úspora energie % (Cyklus)

Dotyková tlačítka	Funkce
	Přístup k informační nabídce: stav stroje, tlaky, teploty, obecná nastavení, spotřeba, uživatelské heslo
	šedá = žádná alamy Červené = varování Červené Bliká = alamy
	Sušička šedá = svítí šedě Cycling zelená = bliká zeleně Kompresor zelená = svítí modrý
	šedě = Odtok kondenzátu OFF zeleně = Odtok kondenzátu ON

Funkce
Trend rosného bodu PDP 8.0

Dotyková tlačítka	Funkce
	Dotkněte se: pro manuální odtok
Funkce	Strep led: modrý = Kompresor zelená zelená = Úspora energie Červené = alamy

5.2 Hlavní nabídka

Dotkněte se k otevření nabídky "Informace":

Když se dotknete některého z „dotykových tlačítek“, na několik sekund se rozsvítí obrys, který potvrdí, že byl výběr proveden.

To platí pro každé „dotykové tlačítko“ umístěné na ovládacím panelu.

Dotkněte se vrátí na ovládací panel.

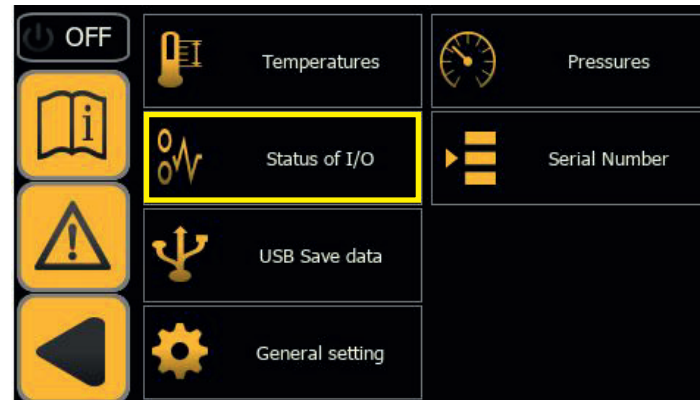

5.2.1 Stav stroje (I/O)

Dotkněte se k otevření nabídky "Stav stroje".

Toto je seznam vstupů: Led indikátor, u popisu, označuje, zda je ochrana/funkce/konfigurace: aktivní = svítí zeleně neaktivní = svítí šedě.

Dotkněte se pro vstup na další stránku.

This is the list of outputs:

Dotkněte se pro návrat do předchozí nabídky.

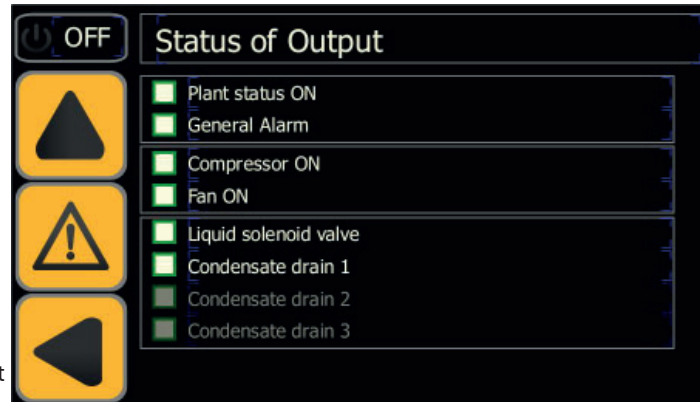
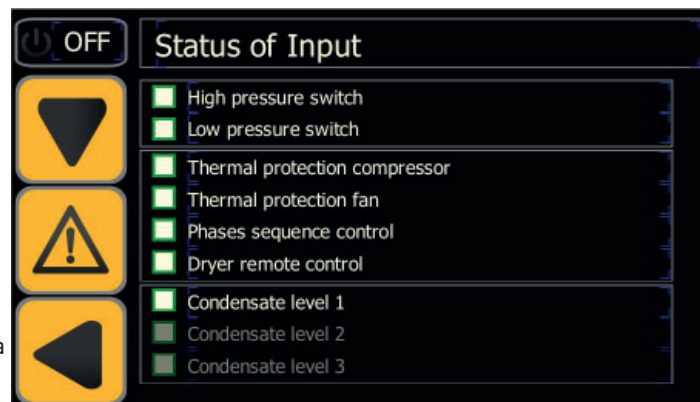

5.2.2 Tlak

Dotkněte se  Pressures k otevření nabídky "Tlak" a zobrazení těchto údajů: kondenzační tlak, provozní rychlost ventilátoru, odpařovací tlak, provozní rychlost ventilu horkého plynu.

Stisknutím konkrétního parametru zobrazíte jeho datový trend výkonu v čase.

"Tlak kondenzace/odpařování"

Použijte  a  posouvejte se po grafu.

Dotkněte se  pro návrat do předchozí nabídky.

"Provozní rychlost ventilu/ventilátoru horkého plynu"

Použijte  a  posouvejte se po grafu.

Dotkněte se  pro návrat do předchozí nabídky.

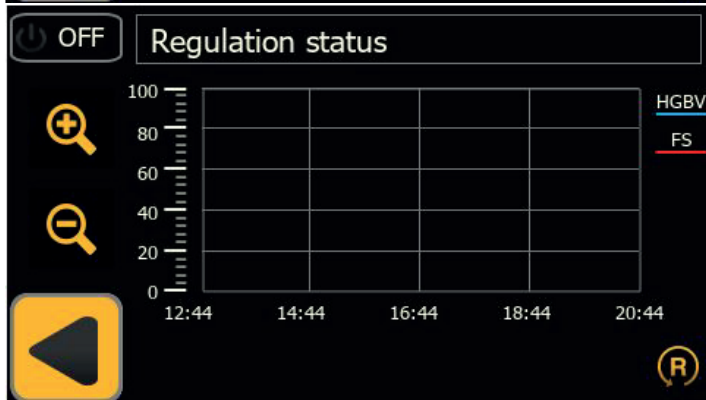
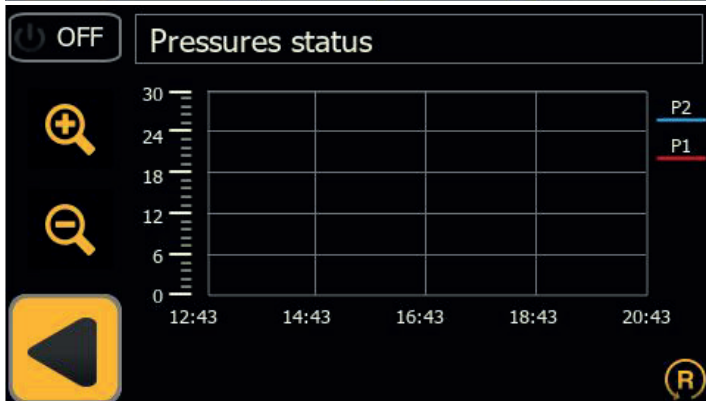
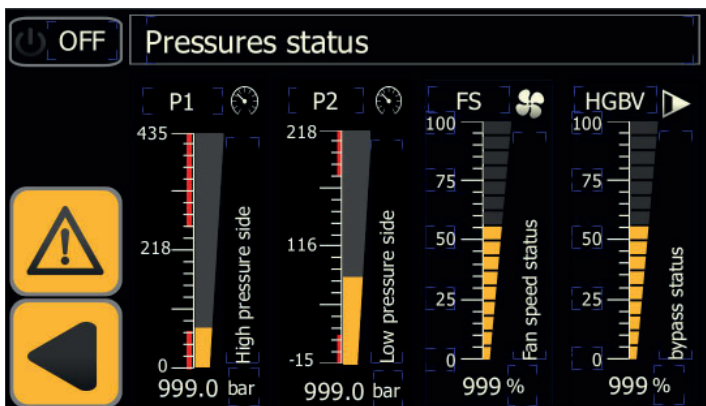

5.2.3 Teplota

Dotkněte se  Temperatures k vizualizaci teploty naměřené teplotními sondami schématu zapojení.

Dotkněte se  pro vstup na další stránku.

B4 = aktivní pouze pro multicooler verzi.

Stisknutím jedné z hodnot nízkotlakých teplot zobrazíte datový trend všech sond v nízkotlakém okruhu.

Klepnutím na jednu z hodnot vysokého tlaku se zobrazí datový trend všech sond ve vysokotlakém okruhu.

Teplota - Nízkotlaká strana

Použijte  a  posouvejte se po grafu.

Dotkněte se  pro návrat do předchozí nabídky.

Teplota - Vysokotlaká strana

Použijte  a  posouvejte se po grafu.

Dotkněte se  pro návrat do předchozí nabídky.

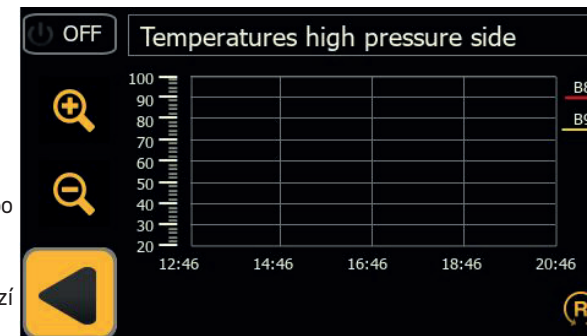
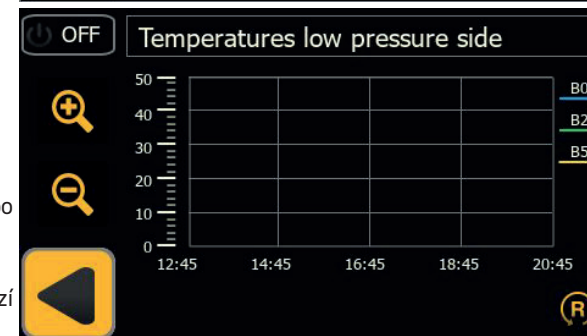
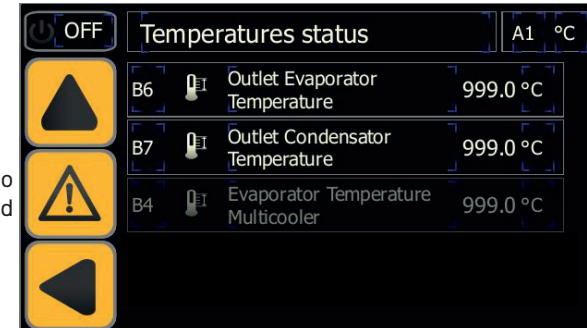
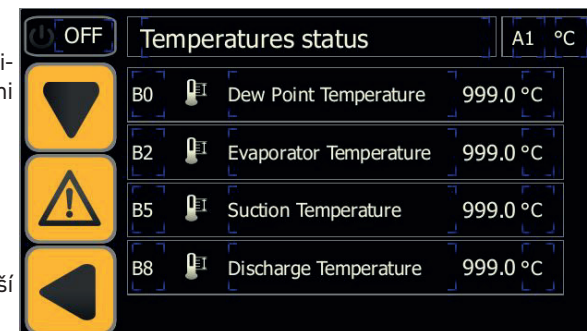

5.2.4 Stahování

Použijte USB s LED, které vám ukazují fázi stahování. (8GB naformátováno jako FAT32) vložte do předního panelu.

Dotkněte se  Touch to save the trends pro spuštění stahování. Doba stahování dat závisí na množství uložených dat.



5.2.5 Údaje o sériovém čísle

Dotkněte se  Serial Number pro vstup do nabídky "Serial number data".

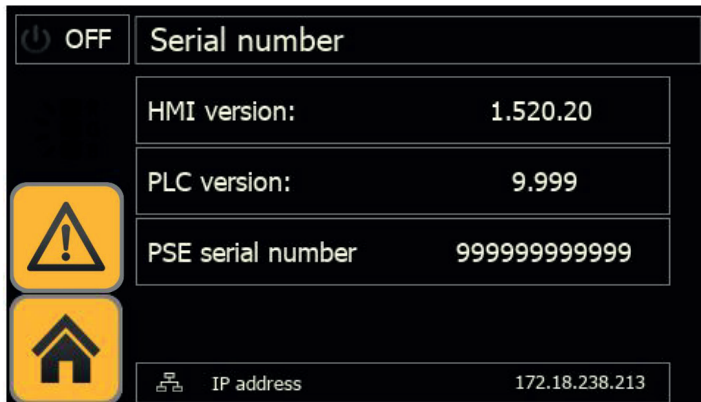

Dotkněte se  vrátí na ovládací panel.

5.2.6 Obecné pokyny

Dotkněte se  General setting pro vstup do „obecné“ nabídky s následující částí: jazyk; datum/hodina; parametr; údržba; cyklický/kontinuální provoz.

dotkněte se libovolné nabídky, kterou chcete zobrazit / upravit.

Dotkněte se  vrátí na ovládací panel.

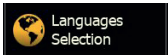

5.2.6.1 Jazyk

Dotkněte se  a vstupte do nabídky jazyků. Dotkněte se jazyka, který potřebujete. Automaticky se vrátíte do hlavní nabídky se zvoleným jazykem.

Dotkněte se  pro návrat do předchozí nabídky.

Dotkněte se jazyka, který potřebujete. Automaticky se vrátíte do hlavní nabídky se zvoleným jazykem.

Dotkněte se  pro návrat do předchozí nabídky.



5.2.6.2 Datum/čas

Dotkněte se  Set Data Time pro vstup do nabídky „Datum/čas“.

Dotkněte se Datum/čas pokračujte ve změně.

Stiskněte na 2 sekundy

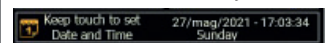

k potvrzení.

Dotkněte se  pro návrat do předchozí nabídky.



5.2.6.3 Nabídky User

Dotkněte se  Users access pro vstup do nabídky "User". Toto menu je vyhrazeno pro servisního technika Parker.

User name:

Password:

Show password

5.2.6.4 Parametr

Dotkněte se  Parameters pro vstup do nabídky „Parametr“ s následujícími částmi: sondy, odtok kondenzátu, konfigurace, údržba, cykly.

Dotkněte se „dotykového tlačítka“ pro vstup do nabídky.

Dotkněte se  pro návrat do předchozí nabídky.



Sondy

Dotkněte se  Probes k nastavení varování a zpoždění nebo minima/maxima rosného bodu.

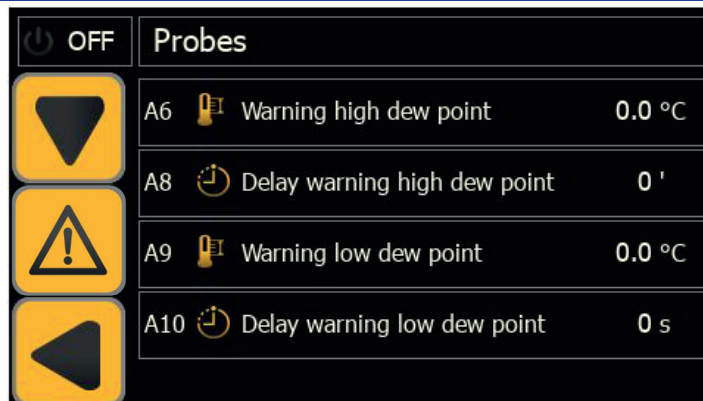

Odtok kondenzátu

Dotkněte se  Condensate drain pro vstup do nabídky „Odtok kondenzátu“. Nastavit:

- časovaný odtok (volba doby zavírání a otevírání);
- kapacitivní odtok;
- kontinuální odtok (externí odtok).

Dotkněte se  pro návrat do předchozí nabídky.



Konfigurace

Dotkněte se  Configuration pro vstup na konfigurační displej s následujícím menu:

- volba teplotního stupně °C/°F;
- povolení dálkového ovládání;
- povolení pouze alarmů nebo alarmů/varování;
- reset nastavení pomocí výchozích parametrů.

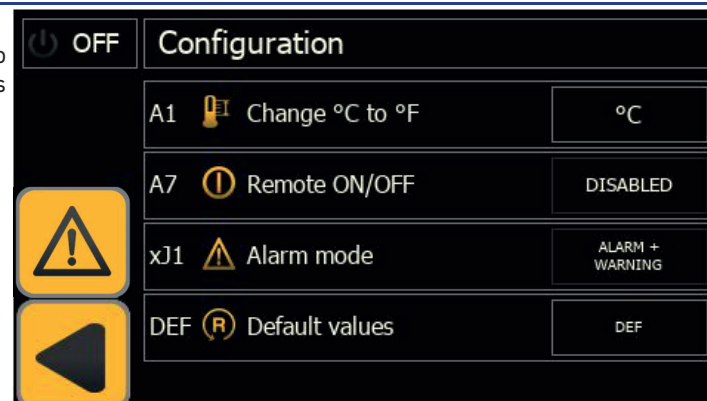

Použijte „dotykové tlačítko“ u popisu a proveďte výběr.

 Chcete-li ovládat režim REMOTE OFF, odstraňte můstek mezi svorkami: 87 -GND a připojte dálkový spínač start/stop (zajistí zákazník).

Údržba

Dotkněte se  Maintenance
tpro zobrazení pracovní doby
kompresoru/sušičky.

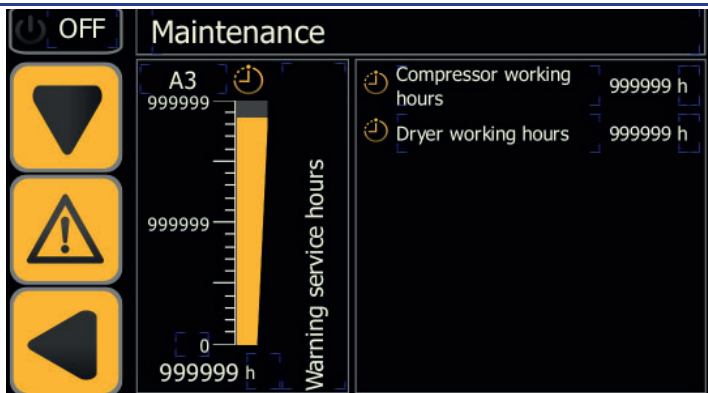

The screenshot shows the 'Maintenance' screen. At the top left is a power button and the word 'OFF'. Below it are three navigation buttons: a downward arrow, a warning triangle, and a leftward arrow. The main area features a vertical bar graph labeled 'Warming service hours' with a scale from 0 to 999999 h. To the right, there are two rows of data: 'Compressor working hours' and 'Dryer working hours', both showing '999999 h'.

Dotkněte se  pro návrat
do předchozí nabídky.

Provoz

Dotkněte se  Cycle a
zvolte typ provozu : kontinuální;
cyklický (úspora energie).

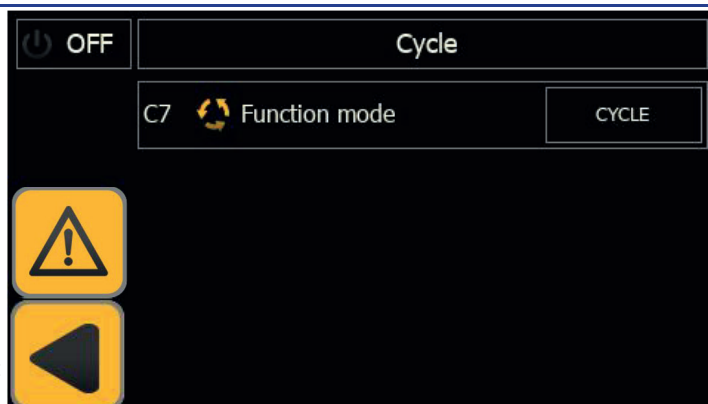

The screenshot shows the 'Cycle' screen. At the top left is a power button and the word 'OFF'. Below it are three navigation buttons: a downward arrow, a warning triangle, and a leftward arrow. The main area features a 'Function mode' section with 'C7' and a 'CYCLE' button.

Použijte „dotykové tlačítko“ u
popisu a proveďte výběr.

Dotkněte se  pro návrat
do předchozí nabídky.

Modbus

Dotkněte se  k
nastavení parametrů Modbus.
MODBUS RTU
(RS485)

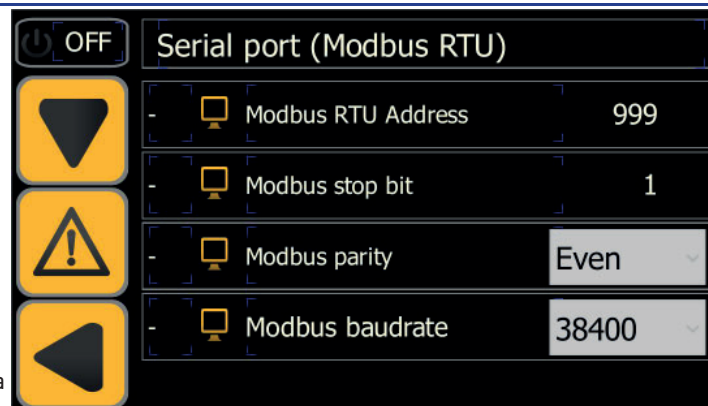

The screenshot shows the 'Serial port (Modbus RTU)' screen. At the top left is a power button and the word 'OFF'. Below it are three navigation buttons: a downward arrow, a warning triangle, and a leftward arrow. The main area contains four rows of settings: 'Modbus RTU Address' (999), 'Modbus stop bit' (1), 'Modbus parity' (Even), and 'Modbus baudrate' (38400).

Dotkněte se  pro vstup na
další stránku.
MODBUS TCP/IP

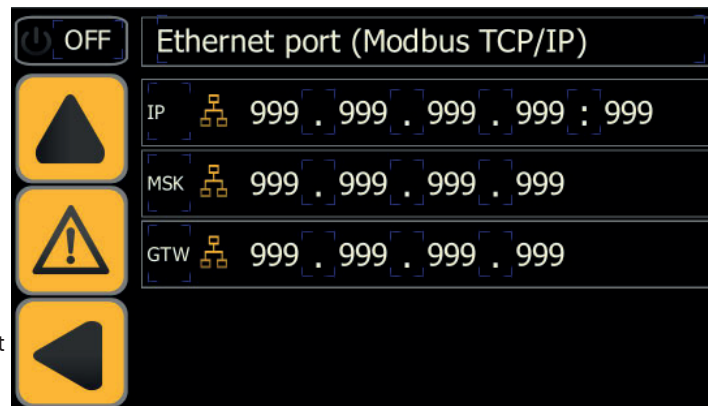

The screenshot shows the 'Ethernet port (Modbus TCP/IP)' screen. At the top left is a power button and the word 'OFF'. Below it are three navigation buttons: a downward arrow, a warning triangle, and a leftward arrow. The main area contains three rows of settings: 'IP' (999 . 999 . 999 . 999 : 999), 'MSK' (999 . 999 . 999 . 999), and 'GTW' (999 . 999 . 999 . 999).

Dotkněte se  pro návrat
do předchozí nabídky.

Vypnutím/zapnutím sušičky potvrďte konfiguraci.

Cloud

Dotkněte se  Cloud Licence
vidět „password“ do cloud.

Tato možnost trvá.



The screenshot shows the 'Cloud Licence' screen. At the top left is a power button and the word 'OFF'. Below it are three navigation buttons: a downward arrow, a warning triangle, and a leftward arrow. The main area contains a single row of settings: a cloud icon and the value '99999'.

Dotkněte se  pro návrat
do předchozí nabídky.

5.3 Alarmy/Varování

Dotkněte se  pro vstup do nabídky „Alarmy/varování“:

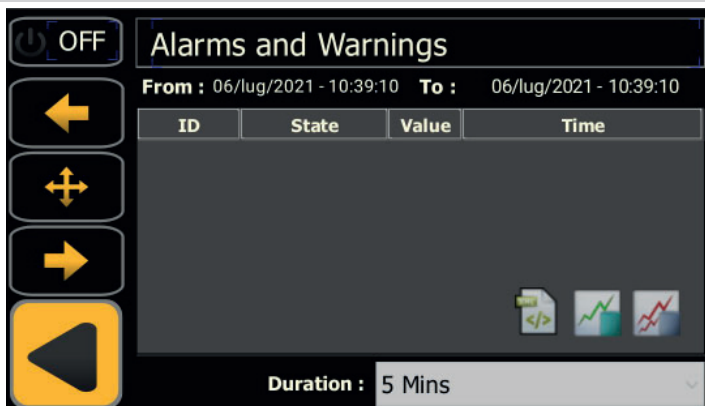



Dotykem „duration“ změníte čas výzkumu.

Po obnovení jmenovitých pracovních podmínek se některá varování a alarmy automaticky resetují, u ostatních alarmů/varování je nutné provést ruční reset.

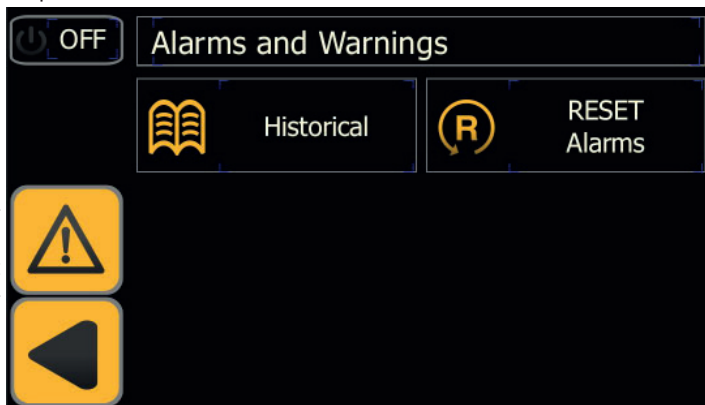
Dotkněte se  a resetujte alarm.



Dotkněte se  pro vizualizaci obrazovky historie alarmů: kód alarmu, datum, počet alarmů, poloha v pořadí výskytu a čas aktivace alarmu.

Dotkněte se  pro návrat do předchozí nabídky.

5.3.1 Seznam poplachů/upozornění

a = Poplach; w = Upozornění.

Code	Poplach/Upozornění	Způsobit
aLD	Poplach Nízký rosný bod	teplota B0<A9 pro více než A10 sekundy .
aLT	Poplach nízké teploty výparníku	teplota B2<A12 pro více než A13 sekundy
aHT2	Poplach vysoká teplota výboje	teplota B8>A11
aHP	Poplach Vysoký tlak	Vysokotlaký spínač aktivní
aLP	Poplach Nízký tlak	Nízkotlaký spínač aktivní
aLTA	Poplach nízká teplota multicooter	teplota B4<A12 pro více než A13 sekundy
aPI*	Poplach Kompresor tepelné ochrany	Kompresor tepelné ochrany aktivní
aPH	Poplach Monitor fáze	Monitor fáze aktivní (pro 460-750)
aCM1	Poplach komunikace expanze 1	expanze 1 nekomunikuje
aCM2	Poplach komunikace expanze 2	expanze 2 nekomunikuje
wB0	Upozornění Sondy B0	sonda poškozená nebo nepřípojená
wB2	Upozornění Sondy B2	sonda poškozená nebo nepřípojená
wB4	Upozornění Sondy B4	sonda poškozená nebo nepřípojená
wB5	Upozornění Sondy B5	sonda poškozená nebo nepřípojená
wB6	Upozornění Sondy B6	sonda poškozená nebo nepřípojená
wB8	Upozornění Sondy B8	sonda poškozená nebo nepřípojená
aFP1	Poplach Vysokotlaký Převodník P1	Převodník poškozená nebo nepřípojená
wHD	Upozornění vysoký rosný bod	teplota B0>A6 pro více než A8 mins
wHT1	Upozornění vysoká teplota výboje	teplota B8>A14 pro více než A15 mins
wHP1	Upozornění Vysoký tlak	tlaků P1>A16 pro více než 2 sekundy
wHB5	Upozornění vysoká teplota sací	teplota B5>A18 pro více než 1 mins
wLP2	Upozornění Nízký tlak	tlaků P2<A21 pro více než 150 sekundy
wSR	Upozornění Plánovaná údržba	doba služby vypršela
wDR1	Upozornění Odtok kondenzátu 1	kondenzát nevytéká z cooler 1
wDR2	Upozornění Odtok kondenzátu 2	kondenzát nevytéká z cooler 2
wDR3	Upozornění Odtok kondenzátu 3	kondenzát nevytéká z cooler 3
aFP2	Poplach Nízkotlaký Převodník P2	Převodník poškozená nebo nepřípojená

* u modelů od 900-1800 může mít alarm také význam obrácených fází.

5.4 Rychlá nabídka

Nabídku otevřete v krátkých krocích:

Zobrazit teplotu

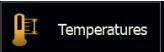
Dotkněte se  → Dotkněte se  Klepnutím na teplotu zobrazíte grafy.

Zobrazit tlak

Dotkněte se  → Dotkněte se  Klepnutím na tlak zobrazíte grafy.

Stáhnout

Dotkněte se  → Dotkněte se  pro stažení.



Údaje o sériovém čísle

Dotkněte se  → Dotkněte se .

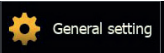
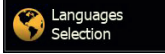

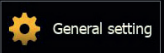

Změnit jazyk

Dotkněte se  → Dotkněte se  → Dotkněte se  vybrat jazyk.

Datum/čas

Dotkněte se  → Dotkněte se  → Dotkněte se  aktualizovat hodiny.

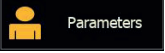
Změnit měrnou jednotku z °C na °F, Dálkové, DEF



Dotkněte se  → Dotkněte se  → Dotkněte se  → Dotkněte se  :

Chcete-li provést změnu, dotkněte se parametru “°C” nebo “°F”.



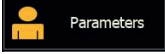
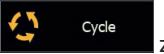

Povolit / zakázat parametr “Remote ON/OFF”.

Dotykem “DEF” parametr resetujete.

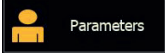

Přepnout do režimu „cyklování”

Dotkněte se  → Dotkněte se  → Dotkněte se  → Dotkněte se  změnit postup.

Odtok

Dotkněte se  → Dotkněte se  → Dotkněte se  → Dotkněte se  vybrat odtok

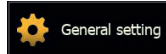
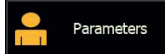
Modbus

Dotkněte se  → Dotkněte se  → Dotkněte se  → Dotkněte se 

Nastavit parametry

Dotkněte se  → Dotkněte se  → Dotkněte se  → Dotkněte se  Při změně parametru stiskněte Enter k potvrzení.

Alarm/varování

Dotkněte se  → Dotkněte se  najít historický alarm a resetovat alarm

Dotkněte se  abyste viděli svůj historický alarm.

Dotkněte se  a resetujte alarm.

6 Údržba

• Stroj byl projektován a zkonstruován pro nepřetržitý provoz; životnost jeho dílů ovšem závisí na prováděné údržbě.

- Při žádosti o pomoc nebo náhradní díly je nutné uvést přesné označení stroje (model a sériové číslo) uvedené na štítku umístěném na jednotce.
- Okruhy obsahující 5t < xx < 50t CO₂ je nutné zkontrolovat nejméně jednou za rok a ověřit, zda nedochází k úniku.
Obvody obsahující 50t < xx < 500t CO₂ je nutné zkontrolovat nejméně jednou za šest měsíců ((EU) č 517/2014, § 4.3.a, 4.3.b).
- U strojů obsahujících 5t CO₂ musí provozovatel uchovávat záznamy s uvedením množství a typu použitého chladiva, případně doplňovaného množství a množství zachyceného během údržby, opravy a konečné likvidace ((EU) č 517/2014 § 6).

6.1 Všeobecná upozornění

- ⚠ Před provedením jakékoli údržby ověřte, že
 - pneumatický okruh již není pod tlakem;
 - sušič je odpojen od elektrické sítě.

📖 Vždy používejte náhradní díly dodané výrobcem: nedodržení tohoto pokynu zbavuje výrobce jakékoli odpovědnosti za špatný chod stroje.

📖 V případě úbytku chladiva se změňte na zkušeného a autorizovaného pracovníka.

📖 Ventil Schrader se má použít pouze v případě nepravdivého provozu stroje: v opačném případě se na škody způsobené špatným plněním chladiva nevztahuje záruka.

6.2 Chladivo















Plnění: na škody způsobené špatným plněním chladiva, které provedl neautorizovaný pracovník, se nevztahuje záruka. 🔄

📖 Zařízení obsahuje fluorované skleníkové plyny.
Chladicí kapalina R 513A normální teplotou a tlakem je bezbarvý plyn ze skupiny SAFETY GROUP A1 - EN378 (kapalina skupiny 2 podle směrnice PED 2014/68/EU);
GWP (Global Warming Potential) = 573.

- ⚠ V případě úniku chladiva vyvětrejte místnost.

6.3 Program preventivní údržby

K zajištění stálé maximální účinnosti a spolehlivosti sušiče proveďte:

Popis činnosti údržby	Interval údržby (za podmínek standardního fungování)				
	Každý den	Každý týden	Každé 4 měsíce	Každých 12 měsíců	Každých 36 měsíců
Činnost zkontrolujte  servis 					
Zkontrolujte, zda kontrolka POWER ON svítí.					
Zkontrolujte ukazatele ovládacího panelu.					
Vyčistěte filtr presostatického ventilu vody, pokud není znečištěný, zvyšte interval kontroly (viz pokyny) (PSE750-1800)					
Zkontrolujte odváděč kondenzátu.					
Vyčistěte žebra kondenzátoru					
Zkontrolujte správné umístění topení vany klikové skříně.					
Zkontrolujte elektrický příkon.					
Zkontrolujte ztráty chladiva.					
Snižte tlak v systému. Proveďte údržbu odváděče.					
Snižte tlak v systému. Vyměňte prvky předfiltrů a postfiltrů.					
Zkontrolujte sondy teploty. V případě potřeby je vyměňte.				 	
Souprava k údržbě sušiče.					



K dispozici je (viz část 8.4):

- sady pro 3-letou preventivní údržbu;
- servisní sady
 - souprava kompresor;
 - souprava ventilátor;
 - souprava automatického ventilu expanze;
- jednotlivé náhradní díly.

6.4 Likvidace

Chladicí kapalina a mazací olej obsažené v okruhu je nutné rekuperovat v souladu s platnými místními předpisy.

Znovuzískání kapalného chladiva se provádí před konečným odstraněním zařízení ((EU) č 517/2014 § 8).

 Recycling	 Recycling Disposal
ocelové konstrukce	ocel/epoxydové-polyesterové pryskyřice
výměník	hliník
trubky/kolektory	hliník/měď /uhlíková ocel
odváděč	polyamide
izolace výměníku	EPS (syntetizovaný polystyren)
izolace trubek	syntetická guma
kompresor	ocel/měď/hliník/olej
kondenzátor	měď/hliník
chladivo	R513A
ventily	mosaz
elektrické kabely	měď/PVC

Zařízení obsahující elektrické součásti musí být likvidováno odděleně s elektrickým a elektronickým odpadem v souladu s místní a aktuální legislativou.



7 Jak odstranit poruchu

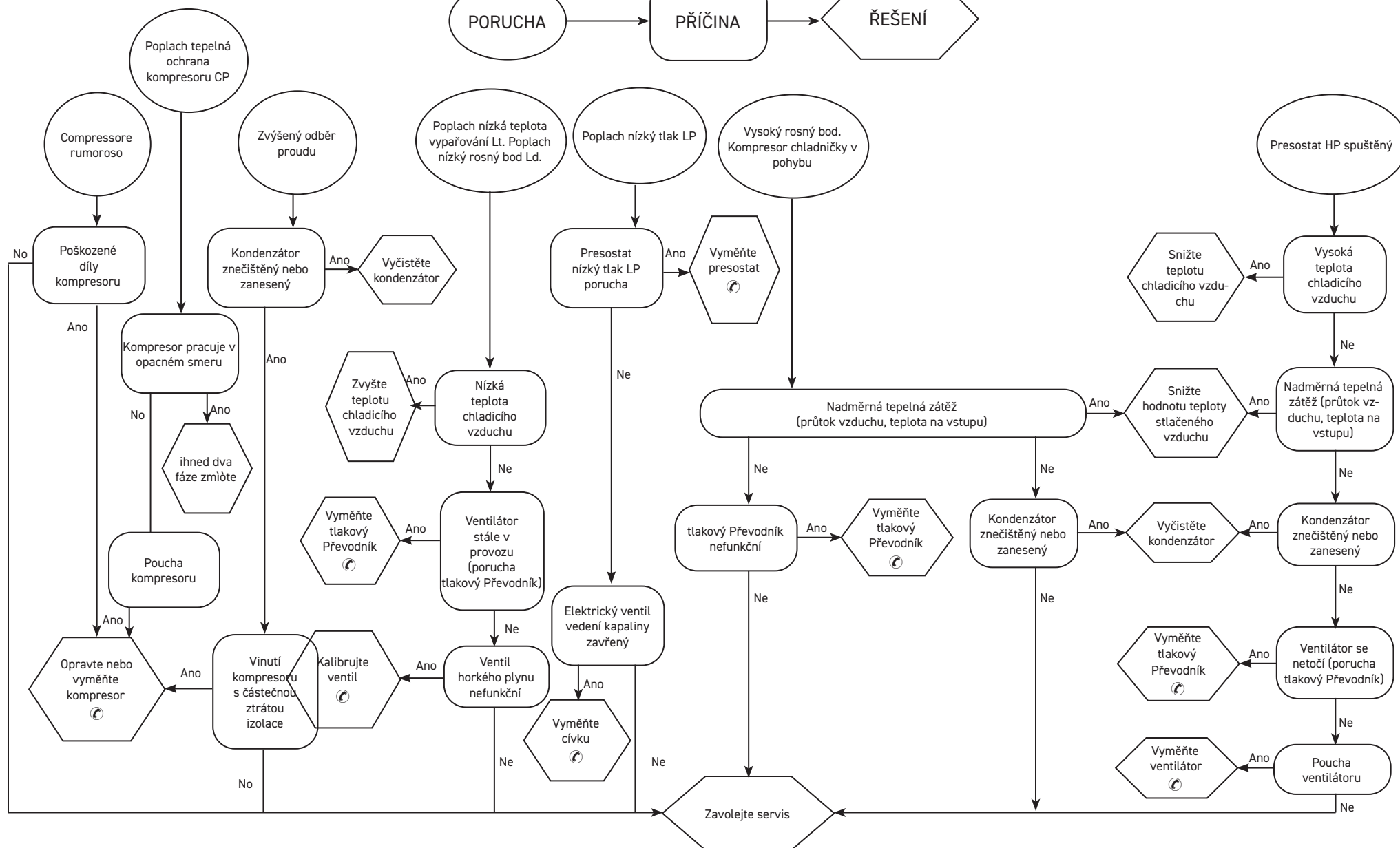

Содержание





1 Техника безопасности	1
1.1 О пользовании руководством	1
1.2 Предупредительные знаки	1
1.3 Указания по безопасности	1
1.4 Неустранимые условия опасности	2
2 Введение	2
2.1 Транспортировка	2
2.2 Перемещение	2
2.3 Проверка	2
2.4 Хранение	2
3 Установка	3
3.1 Указания по установке	3
3.2 Рабочее пространство	3
3.3 Варианты исполнения конденсатор	3
3.4 Рекомендации	3
3.5 Электрические соединения	3
3.6 Слив конденсата	3
4 ПВвод в эксплуатацию	4
4.1 Предварительные проверки	4
4.2 Запуск	4
4.3 Эксплуатация	4
4.4 Выключение	4
5 Управление	5
5.1 Панель управления	5
5.2 Главное меню	5
5.2.1 Состояние машины (I/O)	5
5.2.2 Давление	6
5.2.3 Температура	6
5.2.5 данные серийного номера	7
5.2.6 Общая информация	7
5.2.6.1 Язык	7
5.2.6.2 Дата / время	7
5.2.6.3 Меню User	8
5.2.6.4 Параметр	8
5.3 Аварийные сигналы / предупреждения	10
5.3.1 Перечень Аварийная сигнализация и предупреждения	10
5.4 Оперативное меню	11
6 Техническое обслуживание	12
6.1 Указания общего характера	12
6.2 Refrigerant	12
6.3 Программа планово-предупредительного техобслуживания	12
6.4 Разборка агрегата	13
7 Поиск неисправностей	14
8 Приложение	

1 Техника безопасности

1.1 О пользовании руководством

- Храните руководство на протяжении всего срока службы машины.
- Прочитайте руководство перед выполнением любой операции на машине.
- Руководство подлежит пересмотру и изменениям: для получения новейшую информацию обращайтесь к сопровождающему машину руководству.

1.2 Предупредительные знаки



	Знак, указывающий на информацию о наличии опасности для человека.
	Знак, указывающий на предупреждения, которые необходимо соблюдать в целях исключения повреждения машины.
	Знак, указывающий на необходимость присутствия опытного и авторизованного специалиста.
	Указывает на наличие знаков, значение которых описано в параграфе 8.1

1.3 Указания по безопасности

 Каждый агрегат оборудован электрическим размыкателем, позволяющим оператору выполнять необходимые операции в безопасных условиях. Данный размыкатель всегда следует использовать для исключения опасных ситуаций при проведении работ по техническому обслуживанию.

 Руководство предназначено для конечного пользователя и содержит описание операций, которые должны быть выполнены только при закрытых защитных ограждениях. Выполнение операций, требующих открытия защитных ограждений посредством предусмотренных для этой цели приспособлений, должно быть доверено опытным и квалифицированным специалистам

 Не превышайте расчетные предельные значения, указанные на паспортной табличке.

  Пользователь обязан не допускать нагрузок, отличных от внутреннего статического давления. При наличии сейсмической опасности следует предпринять должные меры по защите агрегата.

 За установку предохранительных устройств в магистрали сжатого воздуха ответственность несет пользователь.

 При определении параметров предохранительных устройств контура сжатого воздуха учитываются технические характеристики установки и местное действующее законодательство. Используйте агрегат исключительно в профессиональных целях и по назначению, согласно проекту.

Обязанностью пользователя является анализ всех аспектов функционирования системы, в состав которой входит агрегат, а также соблюдение всех применимых промышленных стандартов безопасности и всех предписаний, содержащихся в руководстве по эксплуатации агрегата и всей

поставленной вместе с ним документации.

Изменение или замена любого компонента неуполномоченным персоналом и/или использование агрегата не по назначению приведут к аннулированию гарантии.

Изготовитель снимает с себя всякую ответственность за ущерб, который может быть причинен людям, имуществу и самому агрегату в результате небрежности операторов, несоблюдения приведенных в настоящем руководстве указаний, а также невыполнения действующих норм и правил по обеспечению безопасности установки.

Изготовитель не несет ответственность за ущерб, который может быть вызван нарушением и/или изменением упаковки.

 **ВНИМАНИЕ:** Изготовитель оставляет за собой право вносить изменения в положения настоящей инструкции без какого-либо предварительного уведомления. Полную и обновленную информацию см. в инструкции на самом изделии.

1.4 Неустрашимые условия опасности

Установка, пуск в эксплуатацию, выключение и техническое обслуживание машины должны осуществляться при строгом соблюдении указаний, приведенных в сопровождающей машину технической документации и, в любом случае, таким образом, чтобы не вызывать возникновения опасных ситуаций. Опасные ситуации, которые не удалось исключить в стадии проектирования машины, описаны в следующей таблице.

часть машины	тип опасности	условия	меры предосторожности
теплообменная батарея	опасность пореза	контакт	исключать контакт, использовать защитные перчатки
вентилятор и защитная решетка вентилятора	опасность повреждения	ввод заостренных предметов в щели решетки во время работы вентилятора	не вводите какие-либо предметы в щели решетки и не кладите их на решетки
внутренние части агрегата: компрессор и нагнетательная труба	опасность ожога	contatto	evitare il contatto, usare guanti protettivi
внутренние части агрегата: металлические части и электрические кабели	опасность отравления, поражения электрическим током, серьезных ожогов	дефектная изоляция кабелей питания на участке линии перед электрическим шкафом агрегата. Электрические части, находящиеся под напряжением	надлежащая электрическая защита линии питания агрегата. Аккуратное заземление металлических частей
наружная часть агрегата: зона, окружающая агрегат	опасность отравления и серьезных ожогов	пожар в результате короткого замыкания или перегрева линии питания на участке перед электрическим шкафом агрегата	соответствие сечения кабелей и системы защиты линии электропитания действующим нормам и правилам

2 Введение

Настоящее руководство относится к холодильным осушителям, предназначенным для удаления водяного пара из сжатого воздуха.

2.1 Транспортировка

Упакованный агрегат следует:

- поставить в вертикальное положение;
- защитить от воздействия атмосферных осадков;
- защитить от ударов.

2.2 Перемещение

Используйте автопогрузчик с вилочным захватом грузоподъемностью, соответствующей поднимаемому грузу; оберегайте агрегат от ударов во время перевозки.

2.3 Проверка

- На заводе осуществляются сборка, электрическая проводка, заправка хладагентом и маслом всех агрегатов, а также их испытание в стандартных рабочих условиях;
- при получении машины проверьте ее состояние и в случае выявления каких-либо повреждений незамедлительно уведомите об этом транспортную компанию;
- распакуйте машину как можно ближе к месту ее установки.

2.4 Хранение

При необходимости укладывать упакованные агрегаты один над другим, следуйте приведенным на упаковке указаниями. Хранение упакованного агрегата следует осуществлять в чистом и сухом помещении, защитив его от воздействия атмосферных агентов.

3 Установка

Устанавливайте в помещении в чистом, сухом месте, защищенном от непогоды, прямых солнечных лучей и / или других суровых условий.

Установленное изделие должно быть соответствующим образом защищено от риска возгорания (см. EN378-3).

3.1 Указания по установке

Соблюдайте указания, приведенные в пп. 8.2 и 8.3.

Все осушители должны быть снабжены соответствующим фильтром предварительной очистки, установленным вблизи от места входа воздуха в осушитель. Компания-поставщик снимает с себя всякую ответственность за возмещение убытков, связанных с ущербом, прямым или косвенным, который может иметь место в результате того, что предварительный фильтр не был установлен.

Предварительный фильтрующий элемент (для фильтрации частиц размером до 3 микрон или менее) следует заменять не реже одного раза в год или с интервалом, указанным изготовителем.

Выполните правильное подключение осушителя, используя соответствующие входные/выходные присоединения сжатого воздуха.

3.2 Рабочее пространство

Оставляйте вокруг агрегата свободное пространство шириной 1.5 метра. Над осушителями с вертикальной системой выброса конденсационного воздуха оставляйте свободное пространство высотой 2 метров.

3.3 Варианты исполнения конденсатор

Исполнение с воздушным охлаждением (Ac)

Если в поставку не включен, установите сетчатый фильтр на входе конденсационной воды в агрегат.

Исполнение с водяным охлаждением (Wc)

If not provided in the supply, fit a mesh filter on the condensation water inlet.

Характеристики входящей конденсационной воды:

Температура	≥50°F (10°C)	CL ⁻	<50 ppm
ΔT IN/OUT	5-15°C	CaCO ₃	70-150 ppm
Max % гликоль	50	O ₂	<0.1 ppm
Давление	43.5-145 PSig (3-10 barg)	Fe	<0.2 ppm
PH	7.5-9	NO ₃	<2 ppm
Электрическая проводимость	10-500 μS/cm	HCO ₃ ⁻	70-300 ppm
Индекс насыщения по Ланжелье	0-1	H ₂ S	<0.05 ppm
SO ₄ ²⁻	<50 ppm	CO ₂	<5 ppm
NH ₃	<1 ppm	Al	<0.2 ppm

В случае охлаждающей воды особого типа (деионизированной, деминерализованной, дистиллированной) стандартные материалы, предусмотренные для конденсатора, могут оказаться

нелодходящими. В таких случаях необходимо обращаться к компаниизготовителю.

3.4 Рекомендации

Для предотвращения повреждения внутренних компонентов осушителя и воздушного компрессора, исключите установку оборудования в помещениях, окружающий воздух которых содержит твердые и/или газообразные загрязняющие вещества; особое внимание должно быть уделено наличию серы, аммиака и хлора, а также при установке агрегата в морской местности.

В случае исполнений с осевыми вентиляторами не рекомендуется отвод отработанного воздуха по трубопроводам.

3.5 Электрические соединения

Используйте кабель одобренного типа, отвечающий требованиям действующих местных норм и правил (указания по минимальному сечению кабеля см. в параграфе 8.3). На участке линии перед агрегатом установить дифференциальный тепло-магнитный выключатель (RCCB IDn = 0.3A) с зазором ≥ 3 мм между разомкнутыми контактами (смотреть также действующие местные нормы). Номинальный ток In этого магнитотеплового реле должен быть равен FLA, а рабочая характеристика-соответствовать типу D.

Выберите источник питания и вставьте мост, как показано ниже:

S7-S6 на 400/3/50

S8-S6 на 460/3/60

Внутри электрического щитка есть табличка с инструкциями.

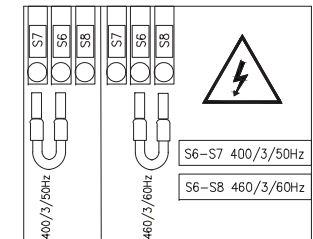

3.6 Слив конденсата

Подключите агрегат к заводской сточной канализации. Устройства отвода конденсата не должны быть подключены к общим замкнутым системам отвода конденсата, работающим под давлением. Проверьте устройства отвода конденсата, чтобы убедиться в правильном сливе жидкости. Удаление конденсата должно производиться в соответствии с действующими местными нормами по охране окружающей среды.

4 Ввод в эксплуатацию

4.1 Предварительные проверки

Перед вводом сушильной машины в эксплуатацию убедитесь в том, что:

- монтаж был выполнен в соответствии с правилами, изложенными в разделе 3;
- клапаны впуска воздуха закрыты, и в машине отсутствует поток воздуха;
- Используется правильный источник электропитания;
- в версии Wc откройте контур охлаждающей воды за несколько минут до запуска сушильной машины.

4.2 Запуск

1. включите питание, повернув главный

переключатель «» в положение «I ON». Появится такая информация:

 **НАГРЕВАТЕЛЬ КОРПУСА ДОЛЖЕН БЫТЬ ВКЛЮЧЕН ЗА 12 ЧАСА ДО ВКЛЮЧЕНИЯ ОСУШИТЕЛЯ.**

После этого нажмите для входа на панели управления.

2. нажмите  для запуска, кнопка меняет цвет с серого на зеленый, указывая на то, что

сушильная машина теперь работает .

3. Запустите сушильную машину до воздушного компрессора; Несоблюдение этого правила может привести к серьезному повреждению компрессора.

 Вентиляторы (версия переменного тока): при неправильной последовательности фаз они меняются в противоположном направлении, при этом возникает риск повреждения (в этом случае воздух выходит из шкафа сушильной машины из решеток конденсатора, а не из решетки вентилятора — см. пункт 8.6 и 8.7 для ознакомления с информацией о правильном направлении потока воздуха); немедленно поменяйте две фазы.

4. Подождите 5 минут, затем медленно откройте клапан впуска воздуха;
5. медленно откройте клапан выпуска воздуха: теперь сушильная машина находится в режиме сушки.

Индикатор фазы

Если при запуске сушильной машины на дисплее появляется аварийный сигнал «Индикатор фазы», пользователь должен проверить проводку входных клемм размыкающего переключателя сушильной машины.

4.3 Эксплуатация

- Оставьте сушильную машину включенной на весь период работы воздушного компрессора;
- Сушильная машина работает в автоматическом режиме, поэтому настройка поля не требуется;
- В случае непредвиденного избыточного расхода воздуха включите режим байпаса, чтобы не допустить перегрузки сушильной машины.

- Избегайте перепадов температуры на входе воздуха.

4.4 Выключение

1. Выключите сушильную машину через 2 минуты после выключения воздушного компрессора или, в любом случае, после прерывания расхода воздуха;
2. Убедитесь в том, что сжатый воздух не попадает в сушильную машину при отключении машины или при возникновении аварийной ситуации.

3. Нажмите  для выключения сушильной машины. Кнопка меняет цвет на серый .

4. Поверните главный переключатель " " в положение «0 OFF», чтобы выключить питание.

 Версия с водяным контуром (Wc): закройте водяной контур после выключения сушильной машины.

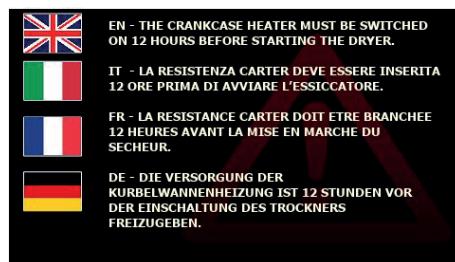

5 Управление

5.1 Панель управления

25/giu/2021 - 11:04:39

LOCAL

FS 0 %
HGBV 0 %
ECO 0 %

0.0 °C
PDP

MANUAL DRAIN

Сенсорные кнопки	Функция
	Сушильную ВЫКЛ (серый)
	Сушильную ВКЛ (зеленый)

LOCAL = локальный
REMOTE = удаленное

Функция	Сенсорные кнопки	Функция
FS 48 % Скорость работы вентилятора (только для версии с воздушным конденсатором)		Доступ к информационному меню: состояние машины, давление, температура, общие настройки, потребление, пароль пользователя
HGBV 14 % Интенсивность работы клапана горячего газа		серый = нет сигнал тревоги красный = предупреждения красный Мигает = сигнал тревоги
ECO 0 % Энергосбережение % (цикл)		Сушильную серый = серый индикатор Езда на велосипеде включено = мигание зеленый компрессора включено = синий индикатор
PDP 8.0 °C График точки росы		серый = Слив конденсата OFF зеленый = Слив конденсата ON
		Показывает ВКЛ/ВЫКЛ слива. Нажмите: для ручного слива
		Функция Strep led: синий = компрессора включено красный = Энергосбережение зеленый = тревоги

5.2 Главное меню

Нажмите для входа в меню «Информация»:

При нажатии одной из «сенсорных кнопок» на несколько секунд загорается наружный контур для подтверждения выбора.

Это касается каждой «сенсорной кнопки», находящейся на панели управления.

Нажмите чтобы вернуться на Панель управления

OFF

Temperatures

Pressures

Status of I/O

Serial Number

USB Save data

General setting

5.2.1 Состояние машины (I/O)

Нажмите для входа в меню «Состояние машины».

Это список входов: Светодиод рядом с описанием указывает на состояние защиты / функций / конфигураций: включено = зеленый индикатор выключено = серый индикатор

Нажмите для перехода на следующую страницу.

Это список выходов:

OFF

Status of Input

- High pressure switch
- Low pressure switch
- Thermal protection compressor
- Thermal protection fan
- Phases sequence control
- Dryer remote control
- Condensate level 1
- Condensate level 2
- Condensate level 3

OFF



Status of Output

- Plant status ON
- General Alarm
- Compressor ON
- Fan ON
- Liquid solenoid valve
- Condensate drain 1
- Condensate drain 2
- Condensate drain 3

Нажмите для возврата в предыдущее меню.



5.2.2 Давление

Нажмите  для входа в меню «Давление» и вывода на экран следующей информации: давление конденсации, скорость работы вентилятора, давление испарения, интенсивность работы клапана горячего газа. Прикоснитесь к конкретному параметру, чтобы просмотреть тенденцию изменения его данных с течением времени. например, “Давление конденсации / испарения”

использовать  и  для прокрутки графика.

Нажмите  для возврата в предыдущее меню.

“Интенсивность работы клапана горячего газа / Скорость работы клапана вентилятора”

использовать  и  для прокрутки графика.

Нажмите  для возврата в предыдущее меню.

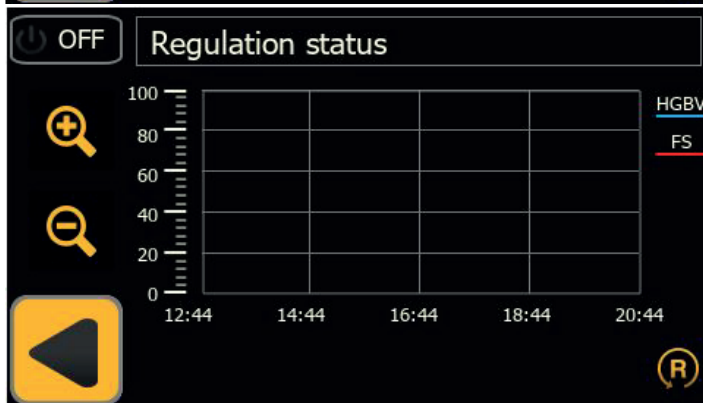
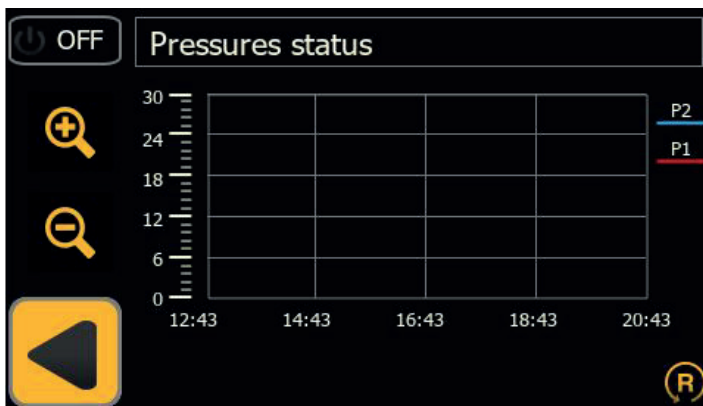
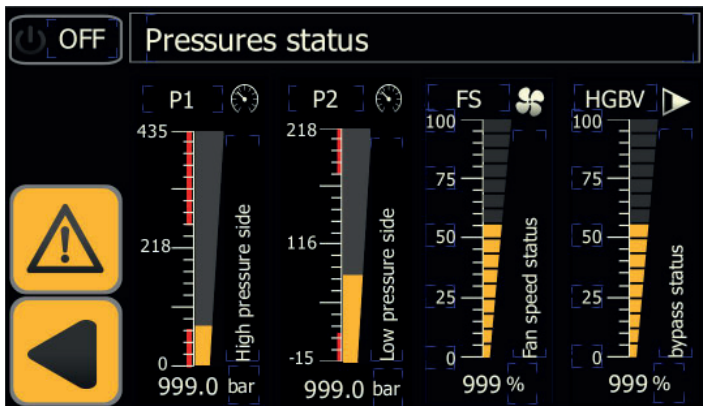

5.2.3 Температура

Нажмите  для отображения показаний температурных датчиков принципиальной схемы.

Нажмите  для перехода на следующую страницу.

B4 = активен только для версии Multicooler. Коснитесь одного из значений температуры низкого давления, чтобы увидеть тенденцию изменения данных всех датчиков в контуре низкого давления. Коснитесь одного из значений температуры высокого давления, чтобы увидеть тенденцию изменения данных всех датчиков в контуре высокого давления.

Температура - Сторона низкого давления

использовать  и  для прокрутки графика.

Нажмите  для возврата в предыдущее меню.

Температура - сторона высокого давления

использовать  и  для прокрутки графика.

Нажмите  для возврата в предыдущее меню.

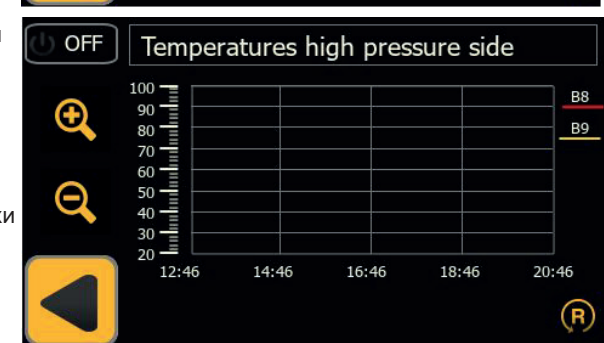
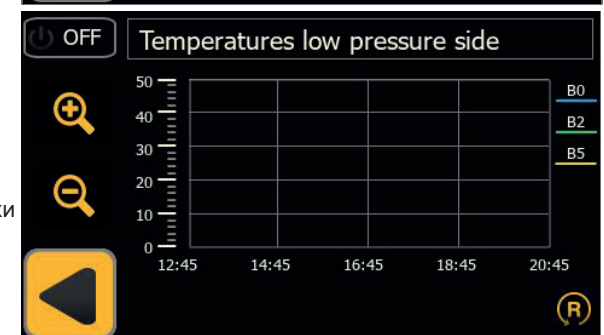
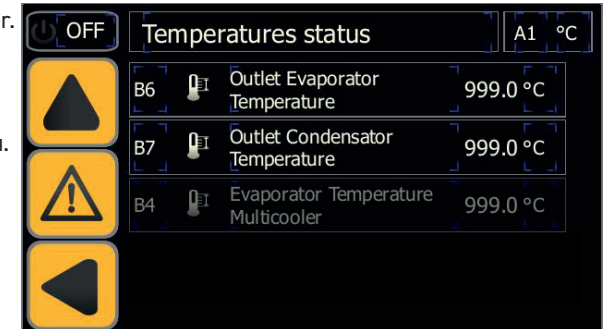
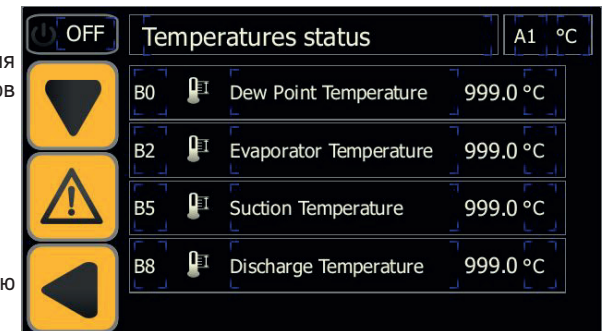

5.2.4 Скачивание

Используйте USB-накопитель со светодиодной индикацией, которая показывает этап загрузки. (8 Гб, отформатированные в FAT32) вставьте в переднюю панель.

Нажмите  Touch to save the trends

чтобы начать загрузку.

Время загрузки данных зависит от объема хранимых данных..

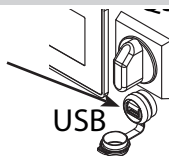

5.2.5 данные серийного номера

Нажмите  Serial Number для входа в окно «Serial number».

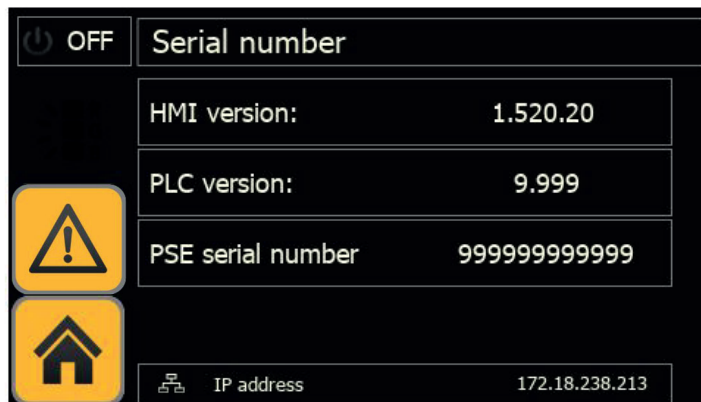

Нажмите  чтобы вернуться на Панель управления.

5.2.6 Общая информация

Нажмите  General setting для входа в меню «Общие настройки» со следующими разделами: язык; дата/время; параметр; техническое обслуживание; циклический / непрерывный режим работы. коснитесь любого меню для просмотра / настройки.

Нажмите  чтобы вернуться на Панель управления



5.2.6.1 Язык

Нажмите  Languages Selection для входа в меню «Язык». выберите необходимый язык. Произойдет автоматический возврат в главное меню с выбранным языком.

Нажмите  для возврата в предыдущее меню.

выберите необходимый язык. Произойдет автоматический возврат в главное меню с выбранным языком.

Нажмите  для возврата в предыдущее меню.



5.2.6.2 Дата / время

Нажмите  Set Data Time для входа в меню «Дата/время»
Нажмите ВРЕМЯ/DATE, чтобы продолжить вносить изменения.

Нажмите на 2 секунды



для подтверждения.

Нажмите  для возврата в предыдущее меню.



5.2.6.3 Меню User

Нажмите  Users access для входа в меню "User".

Это меню предназначено для технического специалиста по обслуживанию компании Parker.

User name:

Password:

Show password

5.2.6.4 Параметр

Нажмите  Parameters для входа в меню «Параметр», содержащее следующие разделы: даты, слив конденсата, конфигурация, техническое обслуживание, цикл.

нажмите «сенсорную кнопку» для входа в меню.

Нажмите  для возврата в предыдущее меню.



Датчики

Нажмите  Probes для настройки предупреждений и задержек или минимального / максимального значения температуры точки росы.

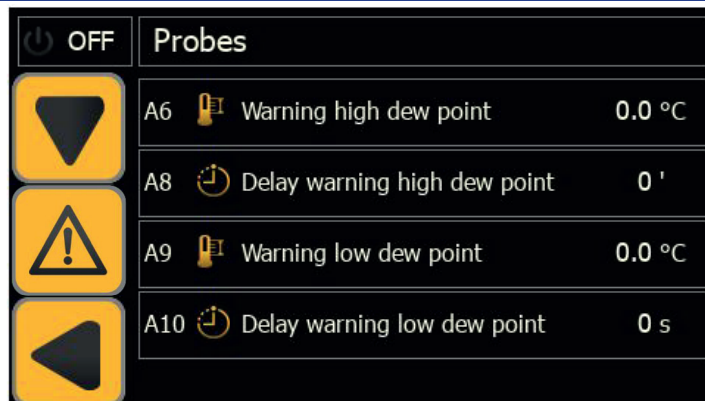

Слив конденсата

Нажмите  Condensate drain для входа в меню «Слив конденсата». устанавливать:

1. спланированный по времени слив (выбор времени закрытия и открытия);
2. емкостный слив;
3. непрерывный слив (наружный слив).

Нажмите  для возврата в предыдущее меню.



Конфигурация

Нажмите  Configuration для входа в представление конфигурации со следующим меню:

1. выбор единиц измерения температуры: °C / °F;
 2. включение дистанционного управления;
 3. включение только аварийных сигналов или аварийных сигналов и предупреждений;
 4. сброс настроек до заданных по умолчанию параметров.
- используйте «сенсорные кнопки» рядом с описанием для выбора параметра настройки.

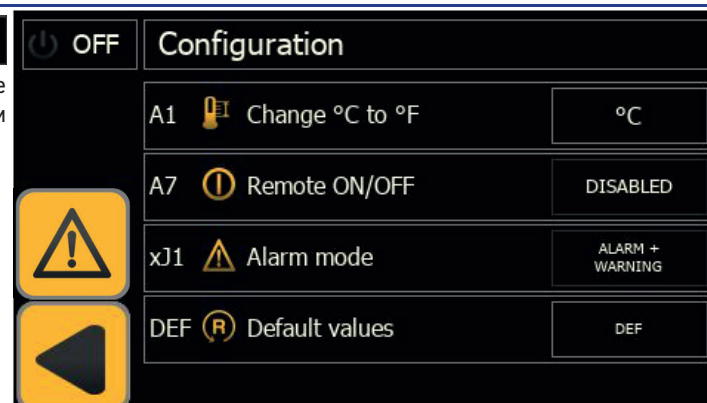

 Для управления режимом «REMOTE OFF» снимите перемычку между клеммами: 87 -GND и подключите дистанционный выключатель пуска/останова (предусматривается заказчиком).

Техобслуживание

Нажмите  Maintenance для просмотра продолжительности работы компрессора / сушильной машины в часах.

Нажмите  для возврата в предыдущее меню.

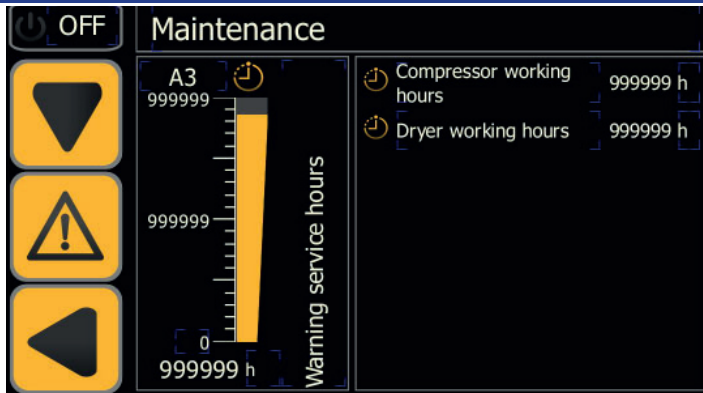

Работа

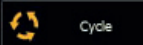
Нажмите  Cycle для выбора режима работы: непрерывный, циклический (экономия энергии).

используйте «сенсорные кнопки» рядом с описанием для выбора параметра настройки.

Нажмите  для возврата в предыдущее меню.

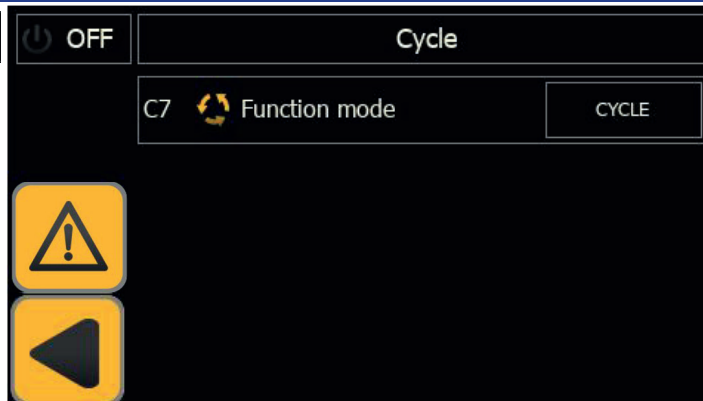

Modbus

Нажмите  для настройки параметров Modbus. MODBUS RTU (RS485)

Нажмите  для перехода на следующую страницу. MODBUS TCP/IP

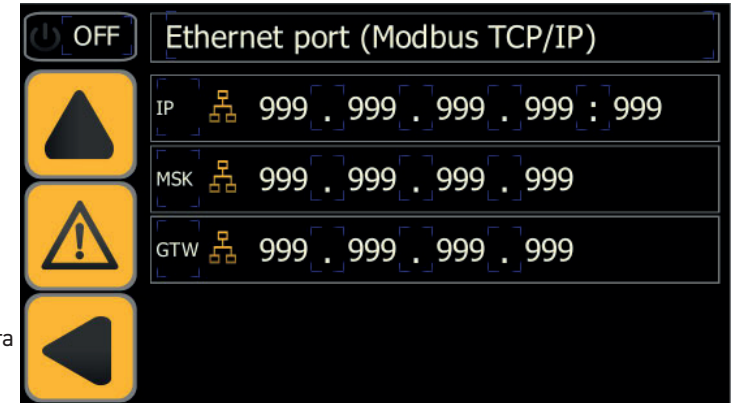
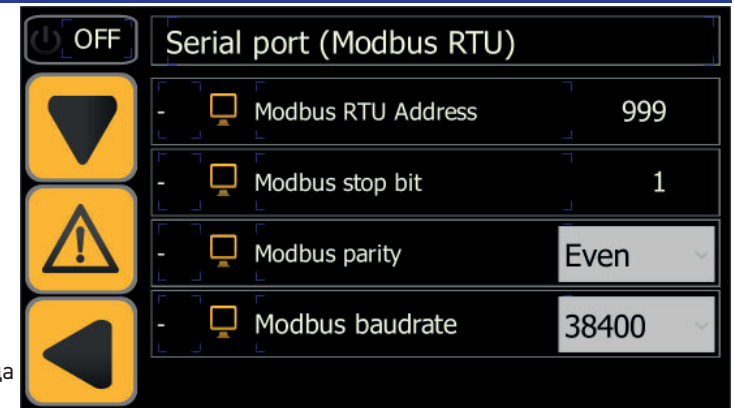

Выключите/включите сушилку, чтобы подтвердить конфигурацию.

Cloud

Нажмите  чтобы увидеть «password» к Cloud.

Этот вариант находится в разработке.

Нажмите  для возврата в предыдущее меню.

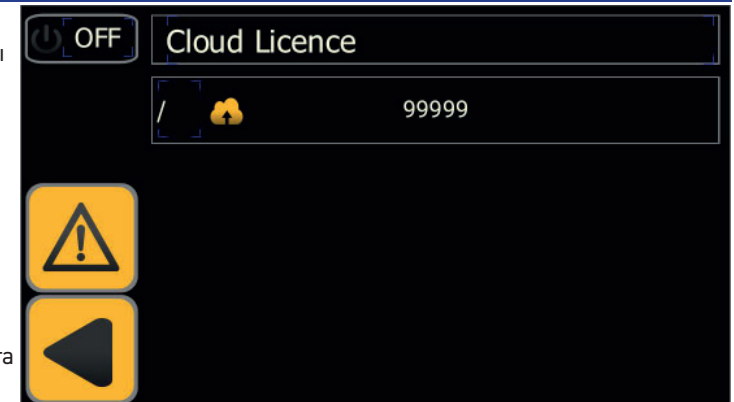

5.3 Аварийные сигналы / предупреждения

Нажмите  для входа в меню «Аварийные сигналы / предупреждения»

Коснитесь «duration», чтобы изменить время исследования.

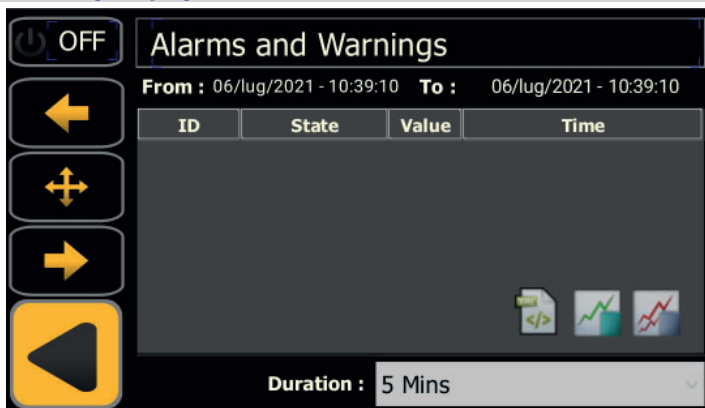

После восстановления штатных условий работы происходит автоматический сброс некоторых предупреждений и аварийных сигналов, но для других аварийных сигналов и предупреждений необходимо выполнить ручной сброс.

Нажмите  для сброса аварийного сигнала

Touch  для отображения журнала аварийных сигналов с указанием следующей информации:

код аварийного сигнала, дата, количество аварийных сигналов, очередность в последовательности их срабатывания и время срабатывания аварийного сигнала.

Нажмите  для возврата в предыдущее меню.

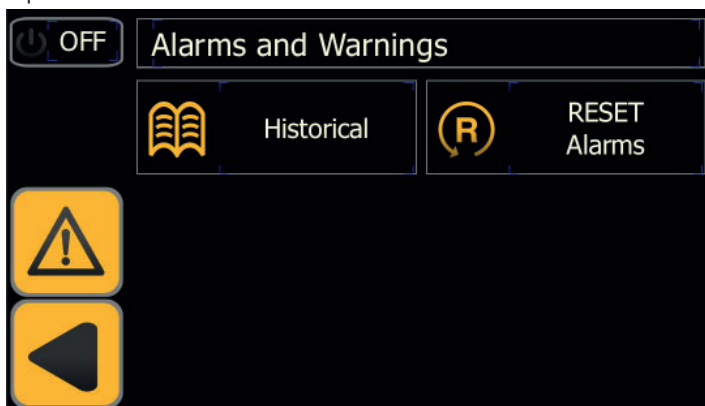

5.3.1 Перечень Аварийная сигнализация и предупреждения

a = Аварийная сигнализация; w = предупреждения.

код	Alarm/Warning	Причина
aLD	Аварийная сигнализация Низкая температура точки росы.	температуре B0<A9 для более чем A10 секунды.
aLT	Аварийная сигнализация низкой температуры испарителя	температуре B2<A12 для более чем A13 секунды
aHT2	Аварийная сигнализация высокой температуре нагнетания	температуре B8>A11
aHP	Аварийная сигнализация Высокое давление.	Реле высокого давления действующий
aLP	Аварийная сигнализация низкого давления	Реле низкого давления действующий
aLTA	Аварийная сигнализация низкой температуре multicooter	температуре B4<A12 для более чем A13 секунды
aPI*	Аварийная сигнализация тепловой защиты компрессора	тепловой защиты компрессора действующий
aPH	Аварийная сигнализация Устройство проверки фаз	Устройство проверки фаз действующий (для 460/750)
aCM1	Аварийная сигнализация коммуникация экспансия 1	расширение 1 не общается
aCM2	Аварийная сигнализация коммуникация экспансия 2	расширение 1 не общается
wB0	предупреждения зонды B0	зонд сломан или не подключен
wB2	предупреждения зонды B2	зонд сломан или не подключен
wB4	предупреждения зонды B4	зонд сломан или не подключен
wB5	предупреждения зонды B5	зонд сломан или не подключен
wB6	предупреждения зонды B6	зонд сломан или не подключен
wB8	предупреждения зонды B8	зонд сломан или не подключен
aFP1	Аварийная сигнализация передатчик высокой давления P1	передатчик сломан или не подключен
wHD	предупреждения Высокое температура точки росы.	температуре B0>A6 для более чем A8 минута
wHT1	Тревога о высокой температуре нагнетания	температуре B8>A14 для более чем A15 минута
wHP1	Предупреждение о высоком давлении	давления P1>A16 для более чем 2 seconds
wHB5	Предупреждение о высокой температуре всасывания	температуре B5>A18 для более чем 1 минута
wLP2	предупреждения низкого давления	давления P2<A21 для более чем 150 секунды
wSR	Предупредительная сигнализация Плановое техническое обслуживание.	время обслуживания истекло
wDR1	предупреждения Слив конденсата 1	конденсат не выходит из cooler 1

wDR2	предупреждения Слив конденсата 2	конденсат не выходит из cooler 2
wDR3	предупреждения Слив конденсата 3	конденсат не выходит из cooler 3
aFP2	Аварийная сигнализация передатчик низкого давления P2	передатчик сломан или не подключен

* для моделей с 900 по 1800 сигнал тревоги также может означать перевернутые фазы.

5.4 Оперативное меню

Оперативный доступ к меню:

Просмотр температуры

Нажмите  → Нажмите  Нажмите на кнопку температуры для просмотра графиков.

Просмотр давления

Нажмите  → Нажмите  Нажмите на кнопку давления для просмотра графиков.

Скачивание

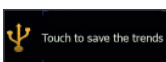
Нажмите  → Нажмите  для скачивания.

данные серийного номера

Нажмите  → Нажмите .

Изменение языка

Нажмите  → Нажмите  → Нажмите  выберите язык.

Дата / время

Нажмите  → Нажмите  → Нажмите  обновление часов.

Изменение единиц измерения температуры с °C на °F, удаленно, DEF



Нажмите  → Нажмите  → Нажмите  → Нажмите 

Коснитесь параметра «°C» или «°F», чтобы внести изменения.

Включить/отключить параметр «Remote ON/OFF».

Нажмите «DEF», чтобы восстановить параметр.

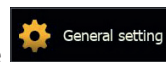
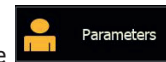
Переключение на «циклический» режим работы

Нажмите  → Нажмите  → Нажмите  → Нажмите  изменение режима работы.

Слив

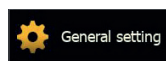
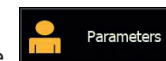
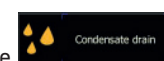
Нажмите  → Нажмите  → Нажмите  → Нажмите  выбор слива.

Modbus

Нажмите  → Нажмите  → Нажмите  → Нажмите 

Параметр настройки

Нажмите  → Нажмите  → Нажмите  → Нажмите 

Параметр настройки

Аварийные сигналы / предупреждения

Нажмите  → Нажмите  найти историческую тревогу и сбросить тревогу.

Нажмите  чтобы увидеть вашу историческую тревогу.

Нажмите  сбросить тревогу.

6 Техническое обслуживание

• Машина была спроектирована и изготовлена с учетом обеспечения длительной и непрерывной работы. Тем не менее, срок службы некоторых из основных компонентов машины зависит от выполнения надлежащего технического обслуживания;

-  При оформлении заказа на сервисное обслуживание или на поставку запчастей укажите модель и серийный номер, приведенные на паспортной табличке, прикрепленной к наружной части агрегата.
- 1 контуры, содержащие 3 или более килограмм хладагента, должны проверяться на наличие утечек не реже раза в год. Контуры, содержащие 30 или более килограмм хладагента, должны проверяться на наличие утечек не реже одного раза в шесть месяцев ((EU) 517/2014 ст. 4.3.a, 4.3.b).
- По установкам, содержащим 3 или более килограмм хладагента, оператор должен вести журнал, в котором следует указывать количество и тип используемого хладагента, количество добавленного и восстановленного хладагента во время операций техобслуживания, ремонта и сдачи установки в утиль ((EU) 517/2014 ст.

6.1 Указания общего характера

 Прежде чем приступить к выполнению любой операции технического обслуживания проверьте следующее:

- отсутствие давления в пневматическом контуре;
- Сосушитель отключен от электрической сети.

 Всегда используйте оригинальные запасные части изготовителя. Использование неоригинальных частей освобождает изготовителя от всякой ответственности в случае неисправной работы машины.

 При наблюдении утечек хладагента обращайтесь к опытному и авторизованному персоналу.

 Клапан Schrader следует использовать только в случае неисправной работы машины. В противном случае ущерб, причиненный в результате неправильной заправки машины хладагентом, гарантией не покрывается.

6.2 Refrigerant

Операция заправки: возможный ущерб вследствие неверной заправки хладагента, выполненной

неуполномоченным персоналом, не покрывается гарантией. 

 Оборудование содержит фторированные парниковые газы.

Хладагент R513A, при нормальных температуре и давлении, представляет собой бесцветный газ группы SAFETY GROUP A1 - EN378 (текущее тело группы 2 согласно директиве PED 2014/68/EU) GWP (Global Warming Potential) = 573.

 В случае утечки хладагента проветривайте помещение.

6.3 Программа плано-предупредительного техобслуживания

Для того чтобы обеспечивать эффективной и безотказной работы осушителя, осуществлять описанные ниже операции технического обслуживания:

Название операции техобслуживания	Интервал техобслуживания (при стандартных условиях работы)				
	Ежедневно	Еженедельно	Раз в 4 месяца	Раз в 12 месяцев	Раз в 36 месяцев
Операция проверка  обслуживание 					
Проверка того, что горит индикатор POWER ON.					
Проверка индикаторов панели управления.					
Очистите фильтр водяного прессостатического клапана, если он не загрязнен, увеличьте интервал проверки (см. Инструкции) (PSE750-1800)					
Проверка устройства слива конденсата.					
Чистка ребр конденсатора.					
Проверка Нагреватель корпуса					
Проверка величины потребляемого тока.					
Проверить на утечки хладагента.					
Сбросить давление в установке. Выполнение техобслуживания устройства слива.					
Сбросить давление в установке. Замена элементов предварительной и заключительной фильтрации.					
Проверить датчики температуры. Заменить их, если необходимо.				 	
Комплект для техобслуживания осушителя.					



Имеются в распоряжении (см. параграф 8.4):

- комплекты для профилактического техобслуживания, проводимого каждые 3 года;
- комплекты для техобслуживания:
 - комплекты для компрессора;
 - комплекты для вентилятора;
 - комплекты для клапана горячего газа;
 - комплекты для испарителя;
- отдельные запасные части.

6.4 Разборка агрегата

Хладагент и смазочное масло должны быть удалены в соответствии с действующими местными нормами по охране окружающей среды.

Возврат хладагента выполнен до окончательного разрушения установки ((EU) 517/2014 ст. 8).

	Утилизация Удаление материалов 
металлоконструкция	сталь/эпоксидные и полиэфирные смолы
теплообменник	алюминий
трубопроводы/ коллекторы	медь/алюминий/углеродистая сталь
конденсатоотводчик	polyamide
изоляция теплообменника	EPS (спеченый полистирол)
изоляция трубопроводов	синтетическая резина
компрессор	сталь/медь/алюминий/масло
конденсатор	медь/алюминий
хладагент	R513A
клапаны	латунь
электрические кабели	медь/PVC

Оборудование, содержащее электрические компоненты, должно утилизироваться отдельно вместе с электрическими и электронными отходами в соответствии с местным и действующим законодательством.



7 Поиск неисправностей

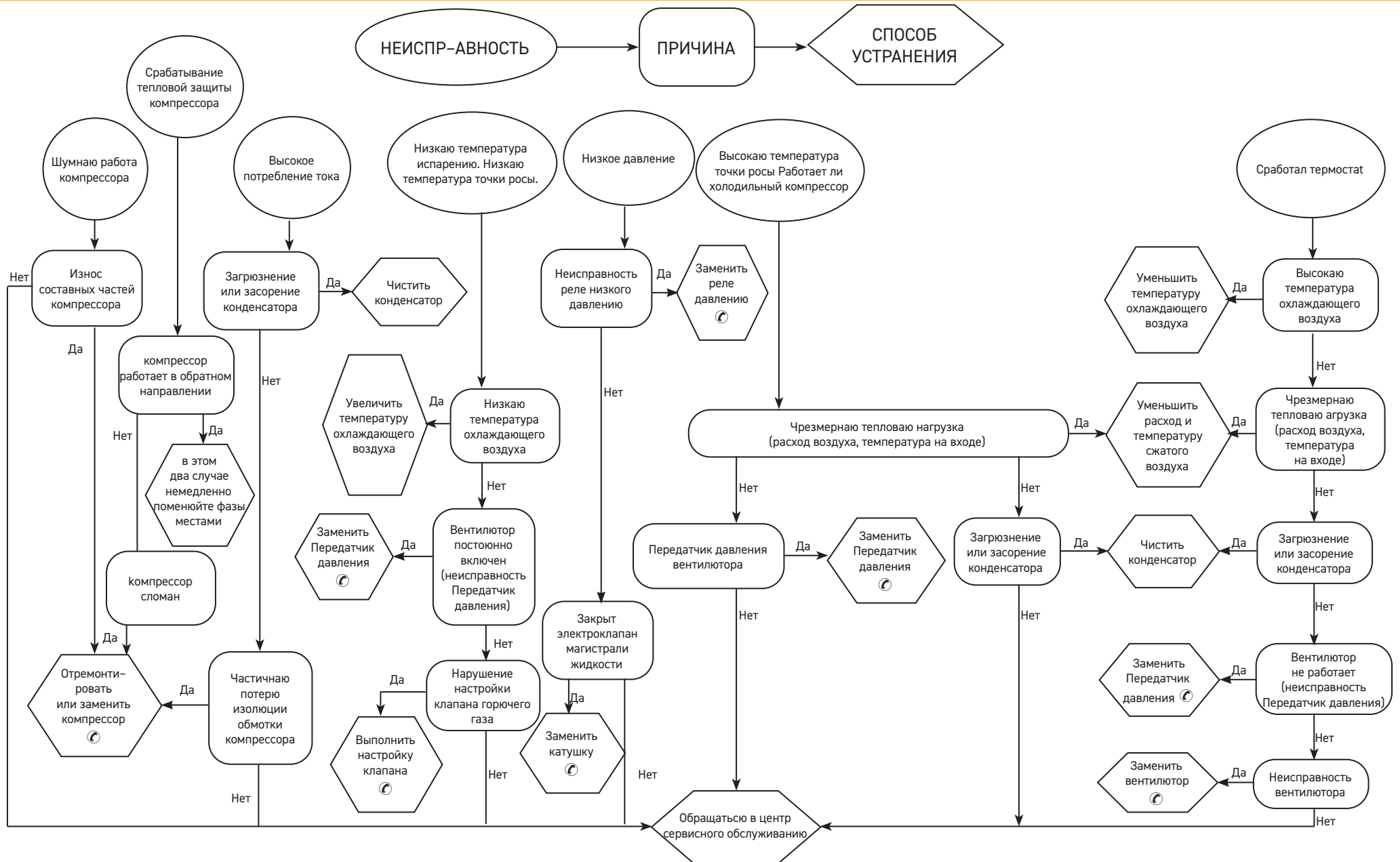

Obsah

1 Bezpečnosť	1
1.1 Dôležitosť návodu	1
1.2 Výstražné a upozorňujúce symboly	1
1.3 Informácie ohľadne bezpečnosti	1
1.4 Zostatkové riziká	2
2 Úvod	2
2.1 Preprava	2
2.2 Premiestňovanie	2
2.3 Kontrola	2
2.4 Skladovanie	2
3 Inštalácia	3
3.1 Postup	3
3.2 Pracovný priestor	3
3.3 Verzia Kondenzátor	3
3.4 Odporúčania	3
3.5 Elektrické zapojenie	3
3.6 Zapojenie odvodu kondenzátu	3
4 Uvedenie do prevádzky	4
4.1 Úvodné kontroly	4
4.2 Zapnutie	4
4.3 Prevádzka	4
4.4 Zastavenie	4
5 Ovládanie	5
5.1 Ovládací panel	5
5.2 Hlavná ponuka	5
5.2.1 Stav zariadenia(I/O)	5
5.2.2 Tlak	6
5.2.3 Teplota	6
5.2.4 Prezatie	7
5.2.5 údaje o sériovom čísle	7
5.2.6.1 Jazyk	7
5.2.6.2 Dátum / čas	7
5.2.6.3 Ponuky User	8
5.2.6.4 Parameters	8
5.3 Zoznam alarmov/výstrah	10
5.3.1 Zoznam alarmov/výstrah	10
5.4 Rýchla ponuka	11
6 Údržba	12
6.1 Všeobecné upozornenia	12
6.2 Chladivo	12
6.3 Program preventívnej údržby	12
6.4 Demontáž	13
7 Identifikácia porúch	14
8 Dodatok	

1 Bezpečnosť

1.1 Dôležitosť návodu

- Tento návod uschovajte pre prípadné ďalšie použitie po celú dobu životnosti stroja.
- Pozorne si ho prečítajte pred akýmkoľvek zákrokom či používaním.
- Zmeny vyhradené: pre aktuálne úpravy odkazujeme na verziu, ktorá je súčasťou stroja.

1.2 Výstražné a upozorňujúce symboly



Opatrenie na zamedzenie nebezpečenstva ohrozenia bezpečnosti a zdravia osôb.



Opatrenie potrebné na zamedzenie nebezpečenstva poškodenia zariadenia.









Vyžaduje prítomnosť autorizovaného technika.



Indikuje výskyt symbolov, ktorých vysvetlenie nájdete v odseku 8.1

1.3 Informácie ohľadne bezpečnosti

-  Vykonávajte vždy údržbárske práce len po odpojení stroja od elektrickej siete.
-  Tento návod sa obracia na koncových používateľov len čo sa týka postupov vykonateľných pri zatvorených paneloch: operácie vyžadujúce ich otvorenie náradím smie vykonávať iba kvalifikovaný odborný personál.
-  Nikdy neprekračujte medzné hodnoty uvedené na údajovom štítku.
-   Používateľ je zodpovedný za to, aby zaťaženie zodpovedalo vnútornému statickému tlaku. V prípade, že hrozí riziko seizmického pohybu, je nutné jednotku patricne zabezpečiť.
-  Bezpečnostné prvky okruhu stlačeného vzduchu zabezpečuje používateľ.
-  Dimenzovanie bezpečnostných zariadení okruhu „stlačeného vzduchu, ktorý berie do úvahy technické charakteristiky, systém a právne predpisy platné na mieste. Jednotka je určená výhradne pre profesionálne použitie a na účely, pre ktoré bola navrhnutá. Používateľ je povinný zhodnotiť všetky aplikačné aspekty inštalácie produktu, dodržiavať všetky aplikovateľné priemyselné bezpečnostné normy ako aj predpisy súvisiace s výrobkom, obsiahnuté v návode na použitie a v akejkoľvek spracovanej dokumentácii, dodanej spolu s jednotkou. Výrobca nenesie žiadnu zodpovednosť za škody spôsobené nedovoleným zaobchádzaním či výmenou komponentov nepovolánym personálom alebo nesprávnym použitím jednotky. Akékoľvek takéto použitie či zásah spôsobí stratu záruky.

Nenesie žiadnu zodpovednosť za prípadné škody na zdraví osôb, na veciach ani na samotnej jednotke spôsobené nedbalosťou obsluhy, nedodržaním pokynov uvedených v tomto návode či nedodržaním ustanovení príslušných platných noriem, súvisiacich s bezpečnosťou zariadenia.

Výrobca nenesie žiadnu zodpovednosť za prípadné škody spôsobené v dôsledku úprav či zmien obalu. Používateľ je povinný uistiť sa o úplnosti dodaných špecifikácií pre výber jednotky, jej komponentov a príslušenstva tak, aby bolo zaistené správne a logicky predvídateľné použitie samotnej jednotky a jej komponentov.

POZOR: Výrobca si vyhradzuje právo zmeniť informácie obsiahnuté v tomto návode bez predchádzajúceho upozornenia. Pre získanie kompletných a aktuálnych údajov odporúčame konzultovať návod, ktorý je súčasťou stroja.

1.4 Zostatkové riziká

Pri inštalácii, spúšťaní, vypínaní a údržbe stroja je nutné riadiť sa vždy postupom, uvedeným v technickej dokumentácii výrobku tak, aby sa predišlo akémukoľvek potenciálnemu stavu nebezpečia. V nasledujúcej tabuľke sú uvedené riziká, ktoré nie je možné odstrániť pri navrhovaní žiadnym technickým riešením.

zainterosovaná časť	zostatkové riziko	spôsob	bezpečnostné opatrenia
výmenník tepla	drobné rezné rany	kontaktným	zabráňte kontaktu, používajte ochranné rukavice
mriežka ventilátora a ventilátor	zranenia	zasunutím špicatých predmetov cez mriežku pri zapnutom ventilátore	nevsúvajte cez mriežku ventilátora ani na ňu neukladajte žiadne predmety
vnútrojšok jednotky: kompresor a výtláčne potrubie	popáleniny	kontaktným	zabráňte kontaktu, používajte ochranné rukavice
vnútrojšok jednotky: mechanické časti a elektrické káble	otravy, úrazy elektrickým prúdom, vážne popáleniny	poškodenia izolácie napájacích káblov pred rozvádzačom jednotky. kovové časti pod napätím	patričná elektrická ochrana napájacieho vedenia. správne uzemnenie kovových častí
vonkajšia časť jednotky: okolitý priestor jednotky	otravy, vážne popáleniny	požiar v dôsledku skratu či prehriatia napájacieho vedenia pred rozvádzačom jednotky	prierezy káblov a ochrana elektrického napájacieho vedenia v súlade s požiadavkami platných noriem

2 Úvod

Táto príručka sa týka chladiacich sušičiek určených na odstraňovanie vodnej pary zo stlačeného vzduchu.

2.1 Preprava

Zabalená jednotka musí zostať:

- vo zvislej polohe;
- chránená pred poveternostnými vplyvmi;
- chránená pred nárazmi.

2.2 Premiestňovanie

Používajte vidlicový zdvižný vozík primeranej nosnosti, podľa hmotnosti zdvíhaného bremena a predchádzajte akýmkoľvek nárazom.

2.3 Kontrola

- Všetky jednotky sú dodané z výrobného závodu v už zmontovanom stave, prepojené káblami, s doplneným chladičom a olejom, podrobené preberacím skúškam pri štandardných prevádzkových podmienkach;
- ihneď po dodávke skontrolujte stav stroja: prípadné zistené škody bezodkladne oznámte prepravcovi;
- rozbaľte jednotku čo najbližšie k miestu inštalácie.

2.4 Skladovanie

V prípade potreby ukladať na seba viacero jednotiek sa riadte pokynmi uvedenými na obale. Udržujte zabalený stroj v čistote, na mieste chránenom pred vlhkosťou a nepriaznivými poveternostnými vplyvmi.

3 Inštalácia

☞ Inštalujte zariadenie v interiéri na čistom a suchom mieste chránenom pred poveternostnými vplyvmi, priamym slnečným žiarením alebo inými drsnými podmienkami.

⚠ Nainštalovaný výrobok musí byť vhodne chránený proti riziku požiaru (odkaz EN378-3).

3.1 Postup

⚠ Pri modeloch sa pred pripojením protistojných častí prírub uistite, že sú svorníky priskrutkované (pozrite ods. 8.6).

☞ Dodržiavajte pritom pokyny uvedené v odsekoch 8.2 a 8.3.

Tutti gli essiccatori devono essere forniti di adeguato pre-filtro installato vicino all'ingresso aria dell'essiccatore. La ditta fornitrice esclude ogni obbligo di indennizzo o risarcimento per eventuali danni diretti o indiretti derivanti dalla mancata installazione del pre-filtro.

☞ Filtračnú vložku do predfiltra (zaisťujúcu účinnú filtráciu až do 3 mikrónov alebo ešte jemnejších častíc) je nutné nahradiť minimálne jedenkrát ročne alebo vo výrobcom stanovenom intervale výmeny.

☞ Správne pripojte sušič k prípojkám vstupu/výstupu stlačeného vzduchu.

3.2 Pracovný priestor

☞ Okolo jednotky nechajte voľný priestor 1,5 m.

Pri modeloch s vertikálnym výstupom kondenzačného vzduchu nechajte nad sušičom 2 m voľný priestor.

3.3 Verzia Kondenzátor

Verzia chladená vzduchom (Ac)

Zamedzte podmienkam, ktoré by umožňovali recirkuláciu chladiaceho vzduchu. Nezakrývajte vetracie mriežky.

Verzia chladená vodou (Ac)

Ak nie je súčasťou dodávky, zabezpečte sitkový filter a upevnite ho na prívod kondenzačnej vody.

☞  Charakteristiky kondenzačnej vody:

Teplota	≥50°F (10°C)	CL ⁻	<50 ppm
ΔT IN/OUT	5-15°C	CaCO ₃	70-150 ppm
Max % glykol	50	O ₂	<0.1 ppm
Tlak	43.5-145 PSIG (3-10 barg)	Fe	<0.2 ppm
PH	7.5-9	NO ₃	<2 ppm
Elektrická vodivosť	10-500 μS/cm	HCO ₃ ⁻	70-300 ppm
Langelierov saturačný index	0-1	H ₂ S	<0.05 ppm
SO ₄ ²⁻	<50 ppm	CO ₂	<5 ppm
NH ₃	<1 ppm	Al	<0.2 ppm

Nezabudnite, že v prípade špeciálnych typoch chladiacej vody, ako napríklad demineralizovaná, deionizo-

vaná alebo destilovaná, bude nevyhnutné kontaktovať výrobcu a overiť, ktorý druh kondenzátora treba použiť, pretože štandardný materiál nemusí byť vhodný.

3.4 Odporúčania

Vyhýbajte sa inštalácii do priestorov, kde môže byť vzduch z okolitého prostredia kontaminovaný pevnými či plynými škodlivinami, predíde sa tak poškodeniu vnútorných komponentov sušiča a vzduchového kompresora: pozor na síru, čpavok, chlór ako aj inštalácie do morského prostredia..

3.5 Elektrické zapojenie

Používajte homologovaný kábel, v zmysle národných predpisov a noriem (minimálny prierez kábla je uvedený v odseku 8.3).

Pred zariadenie zaradte magnetotermický diferenciálny istič (RCCB - IDn - menovitý vybavovací rozdielový prúd = 0,3 A), so vzdialenosťou rozopnutých kontaktov 3 mm (pozri príslušné platné národné normy v danej oblasti).

Menovitý prúd takéhoto magnetotermického ističa "In" musí zodpovedať hodnote prúdu pri plnom zaťažení FLA a krivke D.

Vyberte zdroj napájania a vložte mostík, ako je to znázornené nižšie:

S7-S6 pre 400/3/50

S8-S6 pre 460/3/60

Vo vnútri elektrického panelu je štítok s pokynmi.

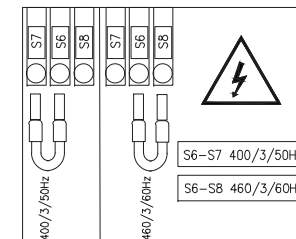

3.6 Zapojenie odvodu kondenzátu

☞ Zabezpečte pripojenie k odvádzacej sústave tak, aby sa predišlo zapojeniu v spoločnom uzavretom obvode s iným tlakovým odvádzacím potrubím. Skontrolujte správne odvádzanie kondenzátu odvádzacím potrubím. Zlikvidujte všetok kondenzát v súlade s platnými národnými normami na ochranu životného prostredia.

4 Uvedenie do prevádzky

4.1 Úvodné kontroly

Pred uvedením sušiča do prevádzky sa uistite:

- že inštalácia bola urobená podľa pokynov uvedených v časti 3;
- že ventily na prívode vzduchu sú zatvorené a že cez sušič neprúdi žiaden vzduch;
- že elektrické napájanie je správne;
- pri verziách Wc niekoľko minút pred zapnutím sušiča otvorte okruh chladiacej vody.

4.2 Zapnutie

1. Zapnite zariadenie otočením Hlavného spínača “



” do polohy „I ON (ZAP)” sušič sa zapne.

zobrazia sa tieto informácie:

 **THE CRANKCASE HEATER MUST BE SWITCHED ON 12 HOURS BEFORE STARTING THE DRYER.**

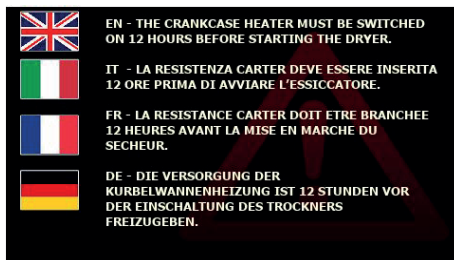

Potom sa dotknite pre vstup na ovládacom paneli.

2. poklepaním tlačidla  sa zmení jeho farba zo šedej na zelenú, čo signalizuje, že sušič je pri-

pravený na používanie .

3. Sušič zapnite pred kompresorom vzduchu;
Nedodržanie tejto podmienky môže vážne poškodiť kompresor.

 Ventilátory (verzia Ac): ak sú zapojené s nesprávnou sekvenciou fáz, budú sa otáčať opačným smerom s rizikom ich poškodenia (v prípade, že vzduch vystupuje zo skrine sušiča z mriežky kondenzátora a nie z mriežky ventilátora - pozrite ods. 8.6 a 8.7, kde nájdete správny prúd vzduchu); okamžite zameňte dve fázy..

4. Počkajte 5 minút, potom pomaly otvorte ventil na prívod vzduchu;
5. pomaly otvorte ventil na výstup vzduchu: sušič teraz suší.g.

Fázový monitor

Ak sa pri zapnutí sušičky zobrazí na displeji alarm „Fázový monitor“, používateľ musí skontrolovať káblové zapojenie vstupných koncoviek vypínacieho spínača sušiča.



4.3 Prevádzka

- Sušič nechajte zapnutý počas celej doby, kým je v prevádzke kompresor vzduchu;
- Sušič funguje v automatickom režime, preto sa nevyžaduje pole nastavení;
- V prípade nepredvídaných nadmerných prúdov vzduchu zaistite obtok, aby sa predišlo preťaženiu sušiča.
- Zabráňte kolísaniam teploty vzduchu na vstupe.

4.4 Zastavenie

6. Sušič zastavte 2 minúty po zastavení kompresora vzduchu alebo pri každom prerušení prúdenia vzduchu;
7. Uistite sa, že po odpojení sušiča alebo pri výskyte alarmu sa do sušiča nebude privádzať stlačený vzduch.



8. Stlačením tlačidla  vypnete sušič. Farba tlačidla sa zmení na šedú 

9. Otočte Hlavný spínač “  ” do polohy „O OFF“, čím vypnete elektrické napájanie.

 Pri verzii Wc po zastavení sušiča zatvorte okruh vody.

5 Ovládanie

5.1 Ovládací panel

25/giu/2021 - 11:04:39

LOCAL

FS 0 % HGBV 0 % ECO 0 %

0.0 °C PDP

MANUAL DRAIN

Dotykové tlačidlá	Funkcia
	Sušička OFF (VYPNUTÉ) (šedá)
	Sušička ON (ZAPNUTÉ) (zeleno)
LOCAL	LOCAL = miestne konfigurácia
REMOTE	REMOTE = Diaľkové konfigurácia

Funkcia	Dotykové tlačidlá	Funkcia
FS 48 % Otáčky ventilátora (iba pre verziu s kondenzátorom vzduchu)		Prístup k informačnej ponuke: stav stroja, hodnoty tlaku, teploty, všeobecné nastavenia, spotreba, heslo používateľa
HGBV 14 % Prevádzková rýchlosť teplotovzdušného ventilu		šedá = žiaden alarm Červená = výstraha Červená Bliká = alarm
ECO 0 % Úspora energie % (Cyklus)		Sušička vypnutá = šedé svetlo Cyklistika aktívna = bliká zeleno Kompresor aktívny = svetlo modra
		šedá = Odtok kondenzátu OFF zeleno = Odtok kondenzátu ON

Funkcia	Dotykové tlačidlá	Funkcia							
8.0 °C PDP Vývoj rosného bodu	MANUAL DRAIN	Dotknite sa: pre manuálny odtok							
		<table border="1"> <thead> <tr> <th>Funkcia</th> </tr> </thead> <tbody> <tr> <td></td> <td>Strep led: modra = Kompresor aktívny</td> </tr> <tr> <td></td> <td>zeleno = Úspora energie</td> </tr> <tr> <td></td> <td>Červená = alarm</td> </tr> </tbody> </table>	Funkcia		Strep led: modra = Kompresor aktívny		zeleno = Úspora energie		Červená = alarm
Funkcia									
	Strep led: modra = Kompresor aktívny								
	zeleno = Úspora energie								
	Červená = alarm								

5.2 Hlavná ponuka

Dotknutím prejdete do ponuky „Informácie“:

Po dotknutí sa niektorého z „dotykových tlačidiel“ sa na niekoľko sekúnd rozsvieti ich orámovanie na potvrdenie výberu pomocou daného tlačidla.

Platí to pre každé „dotykové tlačidlo“ na ovládacom paneli.

Dotknutím sa vrátite na ovládací panel.

OFF

Temperatures

Pressures

Status of I/O

Serial Number

USB Save data

General setting

5.2.1 Stav zariadenia(I/O)

Dotknutím prejdete do ponuky „Stav zariadenia“.

Nasleduje zoznam vstupov: Led dióda, zatvoriť popis, označuje, či je konfigurácia ochrany/funkcií: Aktívna = zelená Neaktívna = šedá

Dotknutím prejdete na nasledujúcu stranu.

OFF

Status of Input

- High pressure switch
- Low pressure switch
- Thermal protection compressor
- Thermal protection fan
- Phases sequence control
- Dryer remote control
- Condensate level 1
- Condensate level 2
- Condensate level 3

This is the list of outputs:

OFF

Status of Output

- Plant status ON
- General Alarm
- Compressor ON
- Fan ON
- Liquid solenoid valve
- Condensate drain 1
- Condensate drain 2
- Condensate drain 3

Dotknutím prejdete do predchádzajúcej ponuky.

5.2.2 Tlak

Dotknutím  prejdete do ponuky „tlak“, v ktorej si môžete nechať zobraziť: kondenzačný tlak, otáčky ventilátora, vyparovací tlak, prevádzková rýchlosť teplovzdušného ventilu.

Dotknite sa konkrétneho parametra, aby ste zobrazili jeho údajový trend v priebehu času.

“vyparovací tlak”

Pomocou  a  sa môžete presúvať v grafe.

Dotknutím  prejdete do predchádzajúcej ponuky.

“prevádzková rýchlosť teplovzdušného ventilu”

Pomocou  a  sa môžete presúvať v grafe.

Dotknutím  prejdete do predchádzajúcej ponuky.

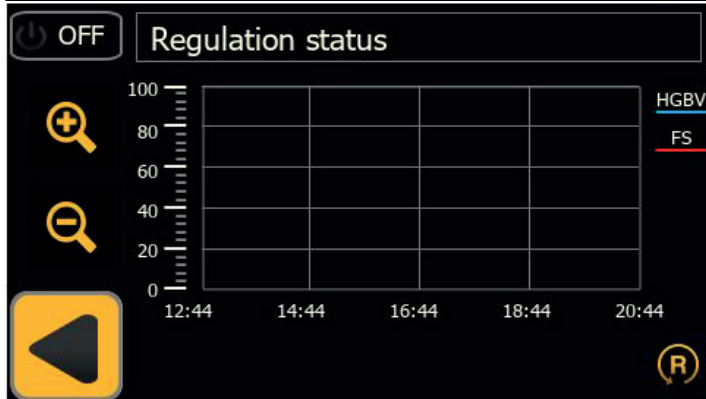
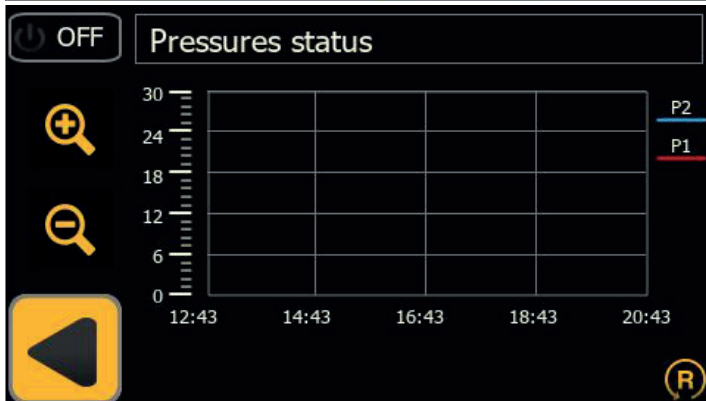
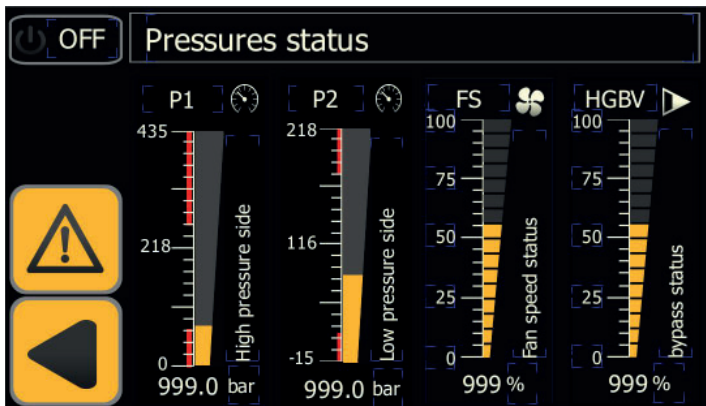

5.2.3 Teplota

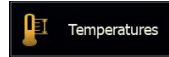
Dotknutím  si necháte zobraziť hodnoty teploty z teplotných snímačov podľa schémy zapojenia.



Dotknutím  prejdete na nasledujúcu stranu.

B4 = aktívne iba pre verziu Multicooler

Dotknite sa jednej z hodnôt nízkotlakových teplôt, aby ste videli trend údajov všetkých sond v nízkotlakom okruhu.



Dotknite sa jednej z hodnôt teploty vysokého tlaku, aby ste videli trend údajov všetkých sond v okruhu vysokého tlaku.

Teplota - Strana nízkeho tlaku

Pomocou  a  sa môžete presúvať v grafe.

Dotknutím  prejdete do predchádzajúcej ponuky.

Teplota - Strana vysokého tlaku

Pomocou  a  sa môžete presúvať v grafe.

Dotknutím  prejdete do predchádzajúcej ponuky.

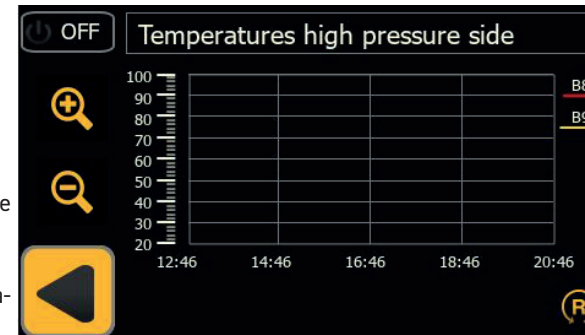
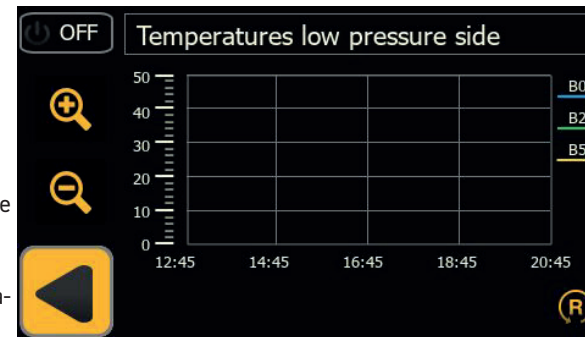
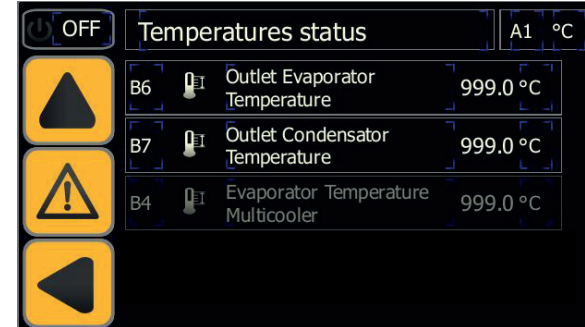
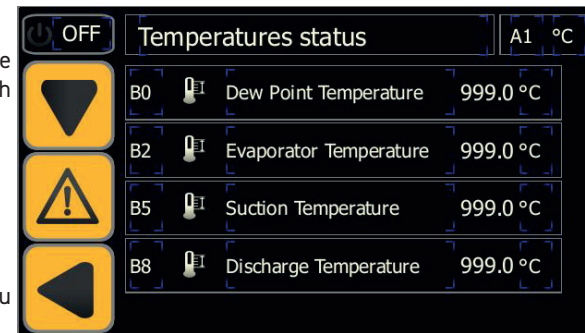

5.2.4 Prevzatie

Použite USB s LED, ktoré zobrazujú fázu sťahovania.
(8gB naformátované ako FAT32) vložte do predného panela.

Dotknutím  na spustenie sťahovania.
Čas sťahovania údajov závisí od množstva uložených údajov.



5.2.5 údaje o sériovom čísle

Dotknutím  prejdete do ponuky „Serial number“.

Serial number	
HMI version:	1.520.20
PLC version:	9.999
PSE serial number	999999999999
IP address	172.18.238.213

Dotknutím  sa vrátite na ovládací panel.

5.2.6 Všeobecné

Dotknutím  prejdete do ponuky „všeobecné“ s nasledujúcou sekciami: jazyk; dátum/hodina; parameter; údržba; cyklická prevádzka/nepretržitá prevádzka.

dotknite sa ktorejkoľvek ponuky, ktorú chcete zobrazit' / upraviť.

Touch  sa vrátite na ovládací panel.

General setting
Languages Selection
Set Data Time
Parameters
Users access

5.2.6.1 Jazyk

Languages Selection

Dotknutím prejdete do ponuky „Jazyk“. Na obrazovke poklepte na jazyk, ktorý si chcete vybrať. Automaticky sa vrátite do hlavnej ponuky s vybraným jazykom..

Dotknutím  prejdete do predchádzajúcej ponuky.

Na obrazovke poklepte na jazyk, ktorý si chcete vybrať. Automaticky sa vrátite do hlavnej ponuky s vybraným jazykom.

Dotknutím  prejdete do predchádzajúcej ponuky.

OFF	English	Italian	German
Warning	Czech	Polish	Slovak

OFF	French	Spanish	Swedish
Warning	Russian	Dutch	Portuguese

5.2.6.2 Dátum / čas

Dotknutím prejdete do ponuky „Dátum/čas“.

Dotknutím Dátum/čas umožníte vykonanie zmeny. Stlačte na 2 sekundy

 27/mag/2021 - 17:03:34 Sunday

výber potvrdíte.

Dotknutím  prejdete do predchádzajúcej ponuky.

OFF	Set Data Time			
Warning	Sec	Seconds 0	Day	Day of month 0
Left Arrow	Min	Minutes 0	Mon	Month 0
	Hou	Hours 0	Yea	Year 2000
	Keep touch to set Date and Time		27/mag/2021 - 17:03:34 Sunday	

5.2.6.3 Ponuky User

Dotknutím  Users access prejdete do ponuky "User". Toto menu je vyhradené pre servisného technika Parker.

User name:

Password:

Show password

5.2.6.4 Parameters

Dotknutím  Parameters prejdete do ponuky „parameter“ s nasledujúcimi sekciami: snímače, odtok kondenzátu, konfigurácia, údržba, cykly.

Do ponuky vstúpíte stlačením „dotykového tlačidla“.

Dotknutím  prejdete do predchádzajúcej ponuky.



Snímače

Dotknutím  Probes nastavíte varovania a oneskorenia alebo minimálnu/ maximálnu hodnotu rosného bodu.

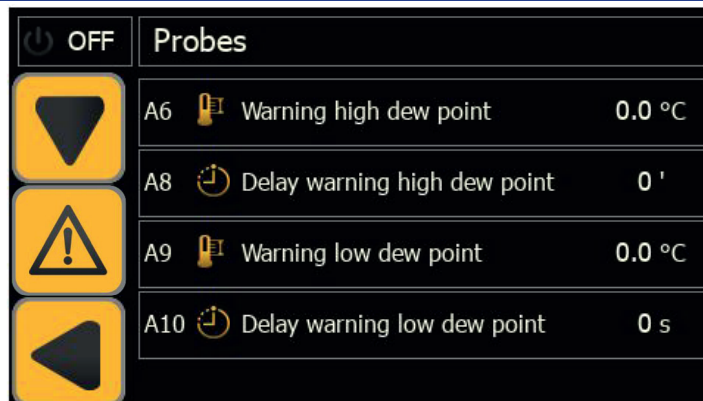

Odtok kondenzátu

Dotknutím  Condensate drain prejdete do ponuky „odtok kondenzátu“. Môžete si vybrať spomedzi nasledujúcich položiek:

1. Časované vypustenie (zadanie času zatvorenia a otvorenia);
2. Kapacitné vypustenie;
3. Priebežné vypustenie (výstupom).

Dotknutím  prejdete do predchádzajúcej ponuky.



Konfigurácia

Dotknutím  Configuration prejdete do zobrazenia konfigurácie s nasledujúcou ponukou:

1. výber zobrazenia teploty v °C / °F;
2. aktivácia diaľkového ovládača;
3. Aktivácia len alarmy / varovania;
4. Zrušenie nastavenia a návrat k predvoleným parametrom.

Pomocou „dotykového tlačidla“ zatvoríte popis a uskutočnite výber.

 Ak chcete spravovať režim REMOTE OFF, odstráňte mostík medzi svorkami: 87 -GND a pripojte diaľkový spínač štart/stop (zabezpečí ho zákazník).

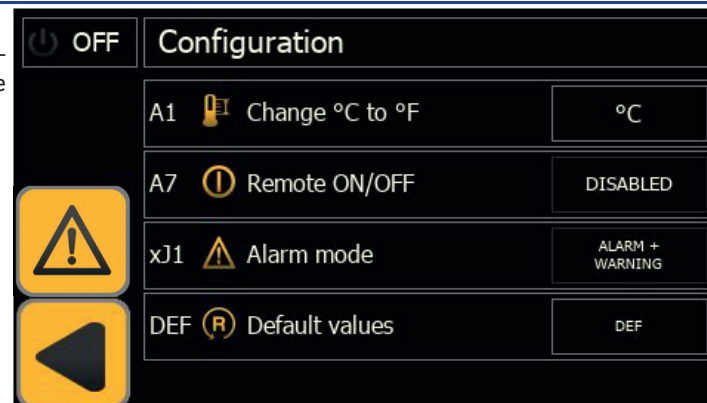

Údržba

Dotknutím  si necháte zobrazit počet hodín prevádzky kompresora/sušiča.

Dotknutím  prejdete do predchádzajúcej ponuky.

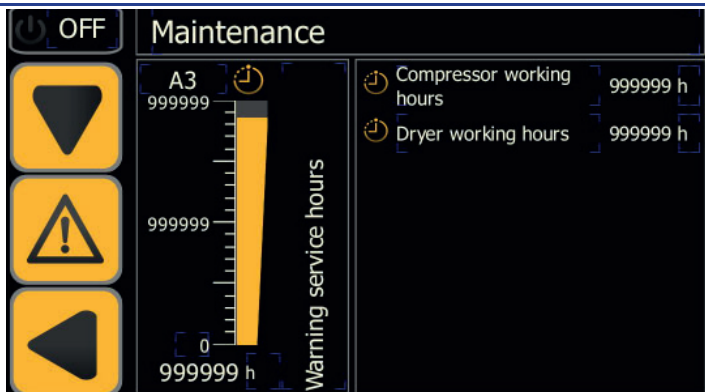

The screenshot shows the 'Maintenance' screen. At the top left is a power button and the word 'OFF'. Below it are three navigation buttons: a downward arrow, a warning triangle, and a leftward arrow. The main area features a vertical bar graph labeled 'Warming service hours' with a scale from 0 to 999999 h. To the right, there are two rows of data: 'Compressor working hours' and 'Dryer working hours', both showing '999999 h'.

Používanie

Dotknutím  si vyberiete typ prevádzky: nepretržitý; cyklický (úspora energie). Pomocou „dotykového tlačidla“ zatvoríte popis a uskutočnite výber.

Dotknutím  prejdete do predchádzajúcej ponuky.

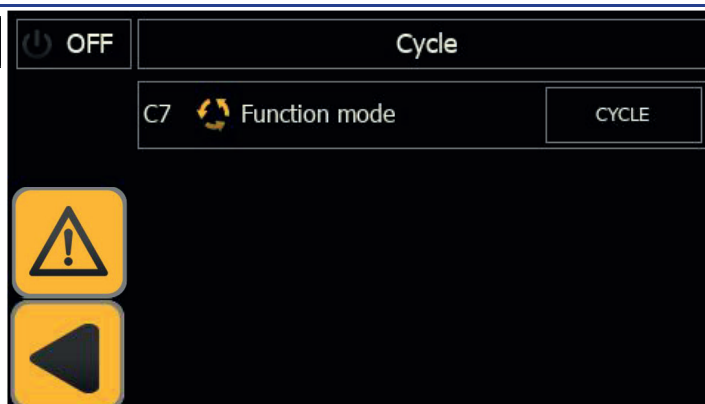

The screenshot shows the 'Cycle' screen. At the top left is a power button and the word 'OFF'. Below it are two navigation buttons: a warning triangle and a leftward arrow. The main area displays 'C7' and 'Function mode' with a 'CYCLE' button to the right.

Modbus

Dotknutím  na nastavenie parametrov Modbus. MODBUS RTU (RS485)

Dotknutím  prejdete na nasledujúcu stranu.

MODBUS TCP/IP

Dotknutím  prejdete do predchádzajúcej ponuky.

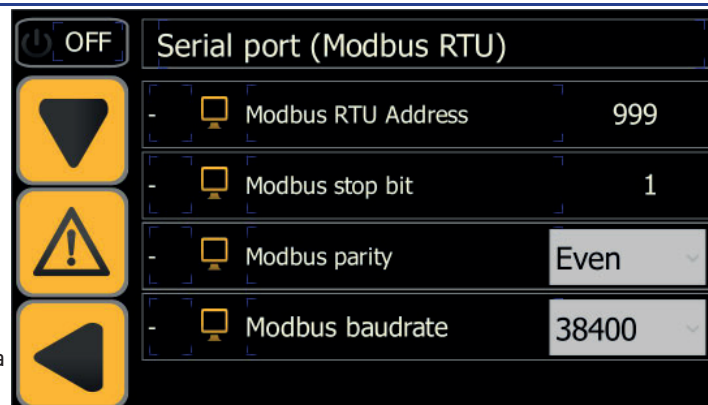

The screenshot shows the 'Serial port (Modbus RTU)' screen. At the top left is a power button and the word 'OFF'. Below it are three navigation buttons: a downward arrow, a warning triangle, and a leftward arrow. The main area contains four rows of settings: 'Modbus RTU Address' (999), 'Modbus stop bit' (1), 'Modbus parity' (Even), and 'Modbus baudrate' (38400).

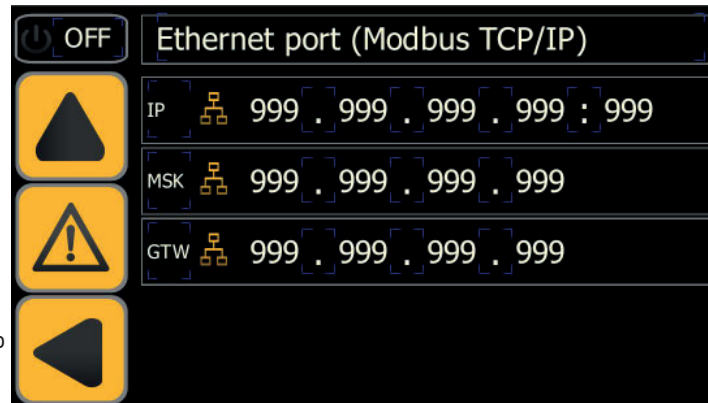

The screenshot shows the 'Ethernet port (Modbus TCP/IP)' screen. At the top left is a power button and the word 'OFF'. Below it are three navigation buttons: a warning triangle, a warning triangle, and a leftward arrow. The main area contains three rows of settings: 'IP' (999 . 999 . 999 . 999 : 999), 'MSK' (999 . 999 . 999 . 999), and 'GTW' (999 . 999 . 999 . 999).

Vypnite/zapnite sušičku, aby ste potvrdili konfiguráciu.

Cloud

Dotknutím  vidieť „password“ do cloud.

Táto možnosť prebieha.

Dotknutím  prejdete do predchádzajúcej ponuky.



The screenshot shows the 'Cloud Licence' screen. At the top left is a power button and the word 'OFF'. Below it are two navigation buttons: a warning triangle and a leftward arrow. The main area displays a password field with a cloud icon and the value '99999'.

5.3 Zoznam alarmov/výstrah

Dotknutím  prejdete do ponuky „Alarmy/výstrahy“.

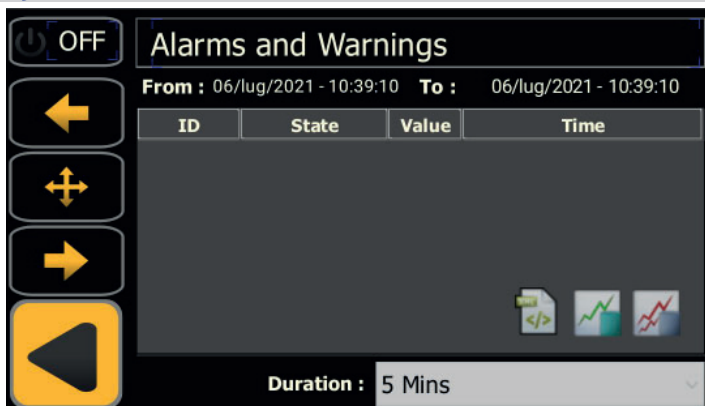



Dotknite sa „duration“, aby ste zmenili čas výskumu.

Po obnove normálneho prevádzkového stavu sa niektoré výstrahy a alarmy automaticky vynulujú, pri ostatných alarmoch/výstrahách je potrebné vykonať ich vynulovanie manuálne.

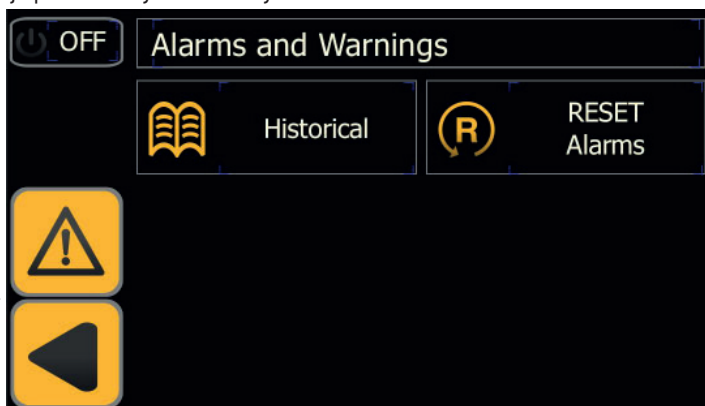
Dotknutím  na zresetovanie alarmu.



Dotknutím  na vizualizáciu histórie alarmov vrátane kódu alarmu, dátumu, počtu alarmov, pozície v slede výskytov a času aktivácie alarmu.

Dotknutím  prejdete do predchádzajúcej ponuky..

5.3.1 Zoznam alarmov/výstrah

a = alarm; w = Výstraha.

kód	Alarm/Warning	Príčina
aLD	Alarm nízkeho rosného bodu	teplotou B0<A9 pre viac ako A10 sekúnd.
aLT	Alarm nízkej teploty výparníka	teplotou B2<A12 pre viac ako A13 sekúnd
aHT2	Alarm pred vysokou teplotou výboja	teplotou B8>A11
aHP	Alarm vysokého tlaku	Vysokotlakový spínač aktívny
aLP	Alarm nízkeho tlaku	Nízkotlakový spínač aktívny
aLTA	Alarm nízkej teploty multicooter	teplotou B4<A12 pre viac ako A13 sekúnd
aPI*	Alarm termálne kompresora	termálne kompresora aktívny
aPH	Alarm Monitor faz	Monitor faz aktívny (pre 460-750)
aCM1	Alarm komunikácia rozpínavosť 1	rozšírenie 1 nekomunikuje
aCM2	Alarm komunikácia rozpínavosť 2	rozšírenie 2 nekomunikuje
wB0	Výstraha sonda B0	sonda zlomená alebo nepripojená
wB2	Výstraha sonda B2	sonda zlomená alebo nepripojená
wB4	Výstraha sonda B4	sonda zlomená alebo nepripojená
wB5	Výstraha sonda B5	sonda zlomená alebo nepripojená
wB6	Výstraha sonda B6	sonda zlomená alebo nepripojená
wB8	Výstraha sonda B8	sonda zlomená alebo nepripojená
aFP1	Alarm vysokotlakový vysielač P1	vysielač zlomená alebo nepripojená
wHD	Výstraha vysokého rosného bodu	teplotou B0>A6 pre viac ako A8 minút
wHT1	Výstraha pred vysokou teplotou výboja	teplotou B8>A14 pre viac ako A15 minút
wHP1	Výstraha vysokého tlaku	tlakom P1>A16 pre viac ako 2 sekúnd
wHB5	Výstraha pred vysokou teplotou sacou	teplotou B5>A18 pre viac ako 1 minútu
wLP2	Výstraha nízkeho tlaku	tlakom P2<A21 pre viac ako 150 sekúnd
wSR	Výstraha pre plánovanú údržbu	čas služby uplynul
wDR1	Výstraha Odtok kondenzátu 1	kondenzát nevyteká z cooler 1
wDR2	Výstraha Odtok kondenzátu 2	kondenzát nevyteká z cooler 2
wDR3	Výstraha Odtok kondenzátu 3	kondenzát nevyteká z cooler 3
aFP2	Alarm nízkeho tlakový vysielač P2	vysielač zlomená alebo nepripojená

*pre modely od 900-1800 môže mať alarm aj význam invertovaných fáz



5.4 Rýchla ponuka

Do ponuky sa dostane len niekoľkými rýchlymi krokmi:

Zobraziť hodnoty teploty

Dotknutím  → Dotknutím  Temperatures Dotknite sa hodnoty teploty na zobrazenie grafov.

Zobraziť hodnoty tlaku

Dotknutím  → Dotknutím  Pressures Dotknite sa hodnoty tlaku na zobrazenie grafov

Prevzatie

Dotknutím  → Dotknutím  Touch to save the trends spustíte preberanie.

údaje o sériovom čísle

Dotknutím  → Dotknutím  Serial Number .





Zmena jazyka

Dotknutím  → Dotknutím  General setting → Dotknutím  Languages Selection Zmeňte používaný jazyk

Date/Time

Dotknutím  → Dotknutím  General setting → Dotknutím  Set Data Time update clock.

Zmena teplotných jednotiek z °C na °F, Remote, DEF





Dotknutím  → Dotknutím  General setting → Dotknutím  Parameters → Dotknutím  Configuration :

Zmenu vykonáte dotknutím sa symbolu parametra „°C“ alebo „°F“.





Povoliť / zakázať parameter “Remote ON/OFF”.

Dotykom “DEF” obnovíte parameter.





Prechod k „cyklickej“ prevádzke

Dotknutím  → Dotknutím  General setting → Dotknutím  Parameters → Dotknutím  Cycle Zmena spôsobu prevádzky





Vypúšťanie

Dotknutím  → Dotknutím  General setting → Dotknutím  Parameters → Dotknutím  Condensate drain Vyberte požadovaný výpusť.

Modbus

Dotknutím  → Dotknutím  General setting → Dotknutím  Parameters → Dotknutím  Communication setting

Nastavenie parametra

Dotknutím  → Dotknutím  General setting → Dotknutím  Parameters → Dotknutím  Probes Zmena parametra.

Alarm/výstraha

Dotknutím  → Dotknutím  nájsť historický alarm a resetovať alarm

Dotknutím  Historical aby ste videli svoj historický alarm.

Dotknutím  RESET Alarms na zresetovanie alarmu.

6 Údržba

• Stroj je konštruovaný a vyrobený tak, aby zaručoval nepretržitú prevádzku. Životnosť komponentov stroja však závisí od vykonávanej údržby.

-  Ak žiadate podporu alebo objednáвате náhradné diely, identifikujte stroj (modelové označenie a sériové číslo) pomocou údajov na výrobnom štítku.
- Okruhy obsahujúce 5t < xx < 50t CO2 sa kontrolujú kvôli hroziacim únikom aspoň raz ročne. Okruhy obsahujúce 5t < xx < 50t CO2 sa kontrolujú kvôli hroziacim únikom v intervale vždy po uplynutí max. šesť mesiacov. ((EÚ) č. 517/2014 čl. 4.3.a, 4.3.b).
- Pri strojoch obsahujúcich 5t CO2 viac musí operátor viesť evidenciu s údajmi o type používaného chladiva, potrebných množstvách a množstvách obnovených počas úkonov údržby, opráv a konečnej likvidácii ((EÚ) č. 517/2014 čl. 6).

6.1 Všeobecné upozornenia

 Skôr ako pristúpite k údržbe skontrolujte:

- či je vypustený tlak v pneumatickom obvode;
- či je sušič odpojený od elektrickej siete.

 Používajte vždy iba originálne náhradné diely od výrobcu: v opačnom prípade výrobca nenesie žiadnu zodpovednosť za prípadné poruchy chodu stroja.

 V prípade unikania chladiva sa obráťte na kvalifikovaný odborný personál.

 Ventil Schrader používajte iba v prípade výskytu funkčných anomálií stroja: v opačnom prípade nebude záručná reklamácia uznaná, záruka sa nevzťahuje na škody spôsobené chybným plnením chladiva.

6.2 Chladivo

Doplnenie chladiva: záruka sa nevzťahuje na škody spôsobené chybným plnením chladiva nepovolným personálom. 

 Zariadenie obsahuje fluórované plyny spôsobujúce skleníkový efekt.

Chladiaca tekutina R513A je pri normálnych teplotách a tlaku bezfarebný plyn, zatriedený do SAFETY GROUP A1 - EN378 (STN EN 378) (tekutina skupiny 2 v zmysle Smernice pre tlakové zariadenia PED 2014/68/EÚ);

Potenciál globálneho otepľovania GWP (Global Warming Potential) = 573.

 V prípade unikania chladiva miestnosť alebo priestor vyvetrajte.

6.3 Program preventívnej údržby

Vykonávajte nasledujúce opatrenia na zaručenie dlhodobej spoľahlivosti a účinnosti sušiča:

Údržba Opis činnosti	Interval údržby (štandardné prevádzkové podmienky)				
	Činnosť	Denne	Týždenne	4 mesiace	12 mesiacov
Kontrola  Servis 					
Skontrolujte, či svieti kontrolka elektrického napájania.					
Skontrolujte kontrolky ovládacieho panela.					
Vyčistite filter presostatického ventilu vody, ak nie je znečistený, predĺžte interval kontroly (pozri pokyny) (PSE750-1800)					
Skontrolujte odtok kondenzátu.					
Vyčistite rebrá kondenzátora.					
Skontrolujte správne umiestnenie kľukovej skrine ohrievača					
Skontrolujte spotrebu elektriny.					
Skontrolujte úniky chladiva.					
Znížte tlak sušiča. Ukončte údržbu odtoku.					
Znížte tlak sušiča. Vymeňte prvky nachádzajúce sa pred filtrom a za ním.					
Skontrolujte teplotné snímače. Podľa potreby ich vymeňte.				 	
Súprava na údržbu sušiča.					



K dispozícii sú nasledujúce (pozrite ods. 8.4):

- Súprava na preventívnu údržbu sušiča na 3 roky;
- servisná súprava
 - súpravy pre kompresor;
 - súpravy pre ventilátor;
 - súpravy pre ventily na horúci plyn;
 - súpravy pre vodu kondenzátora;
- samostatné náhradné diely.

6.4 Demontáž

Zlikvidujte chladiacu tekutinu a mazací olej v súlade s platnými národnými normami na ochranu životného prostredia.

Pred definitívnym zneškodnením zariadenia zabezpečte zachytenie chladiacej tekutiny za účelom likvidácie ((EÚ) č. 517/2014 čl.8).

	Recyklácia Likvidácia 
štruktúra	ocel'/epoxi-polyesterové živice
výmenník	hliník
potrubie	hliník/meď
odvážzač	polyamid
izolácia výmenníka	expandovaný polystyrén (EPS)
izolácia potrubia	syntetický kaučuk
kompresor	ocel'/meď/hliník/olej
kondenzátor	meď/hliník
chladivo	R513A
ventily	mosadz
elektrické káble	meď/PVC

Zariadenia obsahujúce elektrické komponenty sa musia likvidovať oddelene spolu s elektrickým a elektronickým odpadom v súlade s miestnou a súčasnou legislatívou.



7 Identifikácia porúch

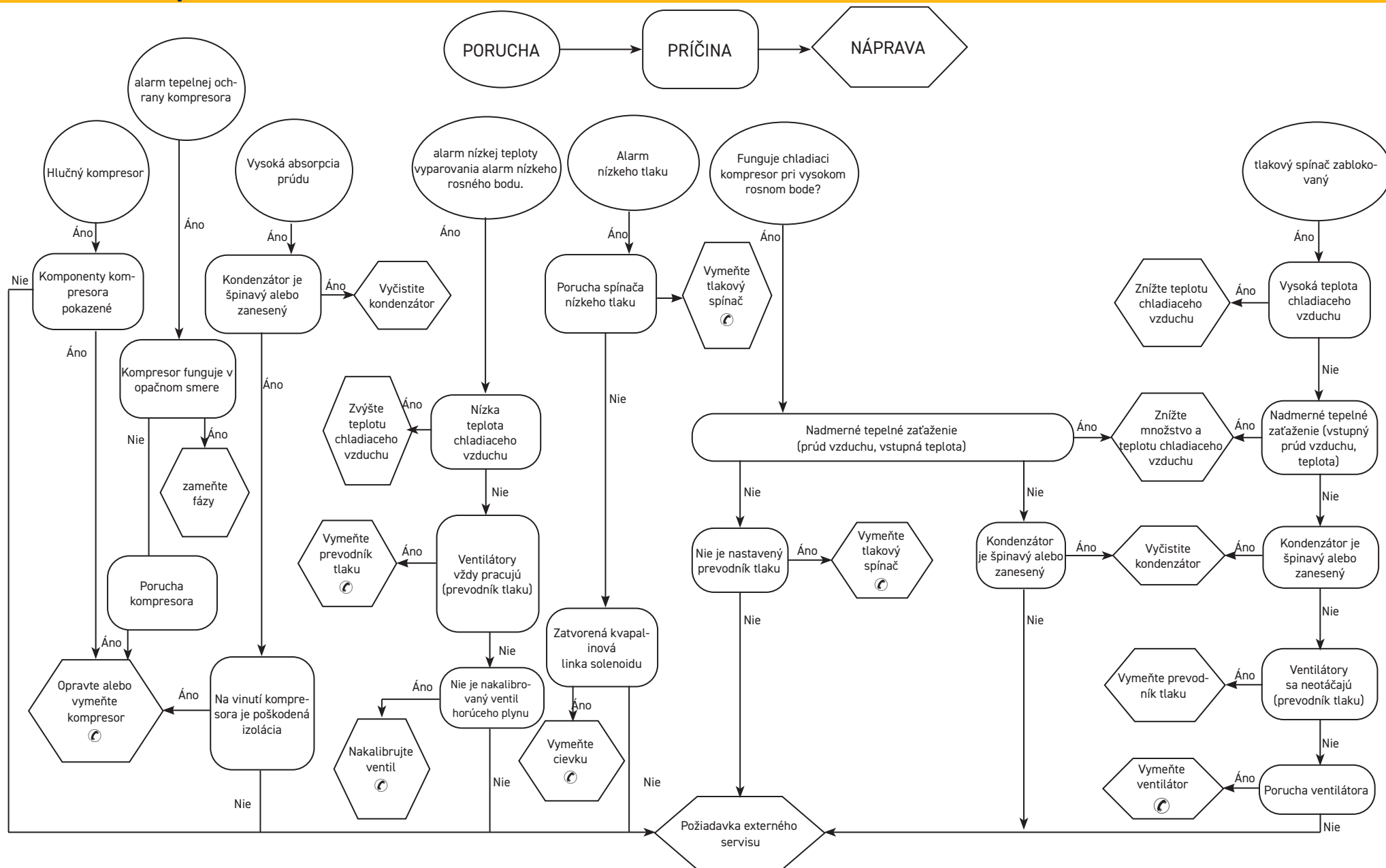

Sisällysluettelo

1 Turvallisuusohjeet	1
1.1 Käyttöohjeiden käyttö.....	1
1.2 Varoitusmerkit.....	1
1.3 Turvallisuusohjeet.....	1
1.4 Muut vaarat.....	2
2 Johdanto	2
2.1 Kuljetus.....	2
2.2 Laitteen siirtäminen.....	2
2.3 Tarkastus.....	2
3 Asennus	3
3.1 Yleistä.....	3
3.2 Asennuksen vaatima tila.....	3
3.3 Lauhdutinversio.....	3
3.4 Suositukset.....	3
3.5 Sähköliitäntä.....	3
3.6 Lauhteenpoistoliitäntä.....	3
4 Käyttöönotto	4
4.1 Alustavat tarkistukset.....	4
4.2 Käynnistys.....	4
4.3 Toiminta.....	4
4.4 Pysäytys.....	4
5 Ohjaus	5
5.1 Perusnäyttö.....	5
5.2 Main menu.....	5
5.2.1 Koneen tila (I/O).....	5
5.2.2 Paine.....	6
5.2.3 Lämpötila.....	6
5.2.4 Lataukset.....	7
5.2.5 Sarjanumeron päivämäärä.....	7
5.2.6 Yleistiedot.....	7
5.2.6.1 Kieli.....	7
5.2.6.2 Päivämäärä/aika.....	7
5.2.6.3 Käyttäjävalikko.....	8
5.2.6.4 Parametri.....	8
5.3 Hälytykset/varoitukset.....	10
5.3.1 Hälytyksen/varoitusten luettelo.....	10
5.4 Pikavalikko.....	11
6 Huolto	12
6.1 Yleisiä varoituksia.....	12
6.2 Jäähdytysaine.....	12
6.3 Ennaltaehkäisevä huolto-ohjelma.....	12
6.4 äteöljyn ja -nesteiden hävittäminen.....	13
7 Vianetsintä	14
8 Liitteet	

1 Turvallisuusohjeet

1.1 Käyttöohjeiden käyttö

- Säilytä käyttöohjeet tallessa koko laitteen käyttöajan ajan.
- Lue käyttöohjeet ennen kuin aloitat mitään toimenpiteitä.
- Oikeus muutoksiin pidetään. Ajan tasalla olevat tiedot löytyvät laitteen mukana toimitetusta käsikirjasta.

1.2 Varoitusmerkit



Henkilövahinkojen vaara.



Noudata ohjetta välttääksesi laitevahingot.





Tarvitaan ammattitaitoisen ja valtuutetun huoltoteknikon toimenpiteitä.





Symbolit on selitetty kohdassa 8.1

1.3 Turvallisuusohjeet

 Jokaisessa yksikössä on päävirtakytkin virran katkaisemista varten, jotta huoltotoimenpiteet voidaan suorittaa turvallisesti. Virta on kytkettävä pois päävirtakytkimestä aina huoltotöiden ajaksi.

 Käyttöohjekirjan sisältämät tiedot on tarkoitettu laitteen käyttäjälle vain siinä määrin kun toimenpiteet voidaan suorittaa suojapaneelleja avaamatta. Kaikki sellaiset toimenpiteet, joissa suojapaneelit tarvitaan avata työkalujen avulla, on jätettävä ammattitaitoisen ja koulutetun henkilöstön tehtäväksi.

 Älä ylitä arvokilvessä mainittuja mitoitusarvoja.

  Käyttäjän vastuulla on välttää kuormituksia, jotka eroavat sisäisestä staattisesta paineesta. Mikäli seismisten vaikutusten riski on olemassa, yksikkö on suojattava asianmukaisesti.

 Paineilmaputkiston turvalaitteet ovat käyttäjän vastuulla.

 Paineilmapiirin turvalaitteiden mitoitus tehdään ottaen huomioon järjestelmän tekniset ominaisuudet ja voimassa olevat paikalliset lait.

Yksikköä saa käyttää ainoastaan ammattikäytössä ja sen käyttötarkoitusta vastaavasti.

Käyttäjän vastuulla on tutkia kaikki siihen käyttökohteeseen liittyvät näkökohdat, johon tuote on asennettu, noudattaa kaikkia sovellettavissa olevia teollisuuden turvastandardeja sekä kaikkia käyttöohjeen ja yksikön mukana toimitettujen muiden asiakirjojen sisältämiä tuotetta koskevia määräyksiä.

Osien käsittely tai vaihto muun kuin valtuutetun henkilöstön toimesta ja/tai yksikön epäasianmukainen

käyttö vapauttavat valmistajan kaikesta vastuusta ja aiheuttavat takuun raukeamisen.

Valmistaja ei vastaa millään tavalla henkilö-, omaisuus- tai laitevahingoista, jotka ovat aiheutuneet käyttäjien huolimattomuuden tai oheisten käyttöohjeiden tai laitteeseen liittyvien turvallisuusmääräysten noudattamisen laiminlyönnin vuoksi.

Valmistaja ei vastaa mahdollisista vahingoista, jotka ovat aiheutuneet pakkaukseen tehtyjen muutosten vuoksi.

Käyttäjän vastuulla on varmistaa, että yksikön tai sen osien ja/tai lisävarusteiden valintaa varten toimitetut tekniset tiedot ovat riittävän kattavia yksikön tai sen osien odotettavissa olevan asianmukaisen tai järkevän käytön tarkoituksessa.

 **HUOMIO:** Valmistaja pidättää oikeuden muuttaa oheisen käsikirjan tietoja ilman etukäteisilmoitusta. Kattavimmat ja ajantasaisimmat tiedot, käyttäjää kehoitetaan ottamaan yhteyttä valmistajaan.

1.4 Muut vaarat

Laitteen asennus, käynnistys, sammutus ja huolto on ehdottomasti suoritettava mukana toimitettujen teknisten asiakirjojen ja ohjeiden mukaisesti sekä lisäksi huolehtien siitä, että minkäänlaisia vaaratilanteita ei pääse syntymään. Vaarat, joita ei ole voitu poistaa suunnittelun keinoin, on esitetty seuraavassa taulukossa.

laitteen osa	vaara	tilanne	varotoimet
lämmönvaihdin	leikkautumisen aiheuttamat haavat	kosketus	vältä koskettamasta, käytä suojakäsineitä
tuulettimen ritilä ja tuuletin	vammat	terävien esineiden työntäminen ritilän aukkoihin tuulettimen käydessä	älä työnnä minkäänlaisia esineitä tuulettimien ritilöiden sisään tai laita mitään ritilöiden päälle
laitteen sisäpuoli: kompressori ja syöttöputki	palovammat	kosketus	vältä koskettamasta, käytä suojakäsineitä
laitteen sisäpuoli: metalliosat ja sähköjohdot	myrkytys, vaarallinen sähköisku, vakavat palovammat	sähkönsyöttökaapeleiden eristyksen vika jännitteellisissä osissa sähkökaapin jälkeen	syöttölinjan asianmukainen sähkösuojaus; erittäin huolellinen metalliosien maadoitus
aitteen ulkopuoli: laitteen ympäristö	myrkytys, vakavat palovammat	oikosulun aiheuttama tulipalo tai syöttölinjan ylikuumentuminen yksikön sähkökaapin jälkeen	kaapelien läpimittojen ja sähkönsyöttölinjan suojajärjestelmän tulee olla voimassa olevien määräysten mukaisia

2 Johdanto

Tämä käyttöohjekirja liittyy jäähdytyskuivaimiin, jotka on tarkoitettu paineilman korkealaatuiseen käsittelyyn.

2.1 Kuljetus

Pakkauksessaan oleva laite on pidettävä:

- pystyasennossa,
- suojattuna sään vaikutuksilta,
- suojattuna törmäyksiltä ja iskuilta.

2.2 Laitteen siirtäminen

Käytä laitteen siirtämisessä haarukkatrukkia, jonka nostovoima on riittävä nostettavaan painoon nähden. Estä kaikenlaiset kolhut ja törmäykset.

2.3 Tarkastus

- Kaikille yksiköille suoritetaan tehtaalla kokoonpano, kaapelointi, jäähdytysaineen ja öljyn täyttö sekä testaus vakiokäyttöolosuhteissa.
- Tarkista laitteen kunto vastaanoton yhteydessä. Jos havaitset vahinkoja, tee välittömästi vahinkoilmoitus kuljetusliikkeelle.
- Pura laite pakkauksestaan mahdollisimman lähellä asennuspaikkaa.

3 Asennus

☞ Tulipalolle alttiissa ympäristössä on huolehdittava asianmukaisesta palonsammutusjärjestelmästä.

⚠ Asennetun tuotteen on oltava asianmukaisesti suojattu palovaaraa vastaan ite EN378-3).

3.1 Yleistä

⚠ Pred pripojením protiprírub nezabudnite zaskrutkovat' závrtné skrutky v prírúbách (pozri prílohu ods. 8.6).

☞ Noudata kohdissa 9.2 ja 9.3 annettuja ohjeita.

Kuivaimen paineilmasyöttö on varustettava asianmukaisella esisuodatuksella.

Myyjä ei vastaa esisuodatuksen puuttumisesta aiheutuvista vioista, toimintahäiriöistä tai siitä aiheutuvista suorista tai välillisistä kustannuksista

☞ Esisuodatinelementti (suodatusaste korkeintaan 3 mikronia) on vaihdettava kerran vuodessa tai valmistajan ilmoittamin aikavälein.

☞ Liitä kuivain asianmukaisesti paineilman tulo- ja poistoliittimiin.

3.2 Asennuksen vaatima tila

☞ Jätä laitteen ympärille 1,5 metriä tilaa.

Jätä kuivaimen yläpuolelle 2 metriä vapaata tilaa malleissa, joissa lauhdeilman puhallus on pystysuuntainen.

3.3 Lauhdutinversio

Ilmakuivainmalli (Ac)

Vältä jäähdytysilman kiertoa. Älä tuki ilmanvaihtoritilöitä.

Vedellä toimiva kuivainmalli (Wc)

Asenna verkkosuodatin lauhdeveden tuloputkeen, jos laitteeseen ei ole asennettu valmiiksi suodatinta.

☞ Lauhdeveden syötön ominaisuudet:

Lämpötila	≥50°F (10°C)	CL ⁻	<50 ppm
ΔT IN/OUT	5-15°C	CaCO ₃	70-150 ppm
Glykoli maks. %	50	O ₂	<0.1 ppm
Paine	43.5-145 PSig (3-10 barg)	Fe	<0.2 ppm
PH	7.5-9	NO ₃	<2 ppm
Sähkön johtavuus	10-500 μS/cm	HCO ₃ ⁻	70-300 ppm
Langelierin kyllästysindeksi	0-1	H ₂ S	<0.05 ppm
SO ₄ ²⁻	<50 ppm	CO ₂	<5 ppm
NH ₃	<1 ppm	Al	<0.2 ppm

Kondensaattorille tarkoitetut vakiomateriaalit voivat olla sopimattomia tietyille jäähdytysvesityypeille (ioniton, mineraaliton, tislattu). Tässä tapauksessa pyydämme ottamaan yhteyttä valmistajaan.

3.4 Suositukset

Kuivaimen ja ilmakompressorin sisäisten osien vaurioitumisen välttämiseksi laitetta ei saa asentaa paikkaan, jossa ympäristön ilma sisältää kiinteitä ja/tai kaasumaisia epäpuhtauksia. Huomioi esim. rikki, ammoniakki, kloori ja mereinen ympäristö. Aksiaalituulettimilla varustetuissa malleissa poistoilmakanavan asennus ei ole suositeltavaa.

3.5 Sähköliitäntä

Käytä paikallisten määräysten ja lainsäädännön mukaista hyväksyttyä kaapelia (kaapelin minimihalkaisija, katso Kappale 9.3).

Asenna magnetoterminen differentiaalikytkin järjestelmän poistopuolelle (RCCB - IDn = 0.3A), kontaktien väli auki-tilassa 3 mm (noudata paikallisia määräyksiä).

Magnetoterminen kytkimen tulon nimellisjännite (In) on oltava sama kuin FLA ja D-tyyppin toimintopideikäry.

Valitse virtalähde ja lisää silta alla kuvatun mukaisesti:

S7-S6 - 400/3/50

S8-S6 - 460/3/60

Sähkötaulun sisällä on ohjetarra.

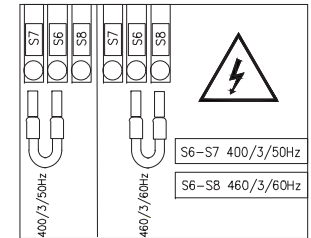

3.6 Lauhtenpoistoliitäntä

☞ Kytke lauhteenpoisto poistojärjestelmään välttämättä samaan suljettuun piiriin muiden paineistettujen poistolinjojen kanssa. Tarkista, että lauhde poistuu asianmukaisesti. Hävitä lauhde paikallisia ympäristömääräyksiä noudattaen.

4 Käyttöönotto

4.1 Alustavat tarkistukset

Tarkista seuraavat asiat ennen kuivaimen käynnistämistä:

- Asennus on suoritettu noudattaen kohdassa 3 annettuja ohjeita.
- Ilmansyöttöventtiilit ovat kiinni ja kuivaimen läpi ei mene ilmavirtaa.
- Syöttöjännite on oikea.
- Laitemallissa Wc : avaa jäähdytysvesipiiri vasta muutama minuutti ennen kuivaimen käynnistämistä.

4.2 Käynnistys

1. Kytke virta päälle kääntämällä PÄÄKYTKIN "  " asentoon I ON. a näyttää nämä tiedot:

 **KAMPIKAMMION LÄMMITIN ON KYTKETTÄVÄ PÄÄLLE 12 TUNTIA ENNEN KUIVAIMEN KÄYNNISTÄMISTÄ.**

Kosketa sen jälkeen päästäksesi ohjauspaneeliin.

2. Käynnistä laite koskettamalla painiketta  Painikkeen väri vaihtuu harmaasta vihreäksi merkiksi siitä, että kuivain on nyt käynnissä .
3. Käynnistä kuivausrumpu ennen ilmakompressoria; Jos tätä määräystä ei noudateta, kompressori voi vaurioitua vakavasti.

 Puhaltimet (ilmajäähdytinmalli): jos puhaltimet kytketään väärään vaihesekvenssiin, ne pyörivät vastakkaiseen suuntaan, jolloin ne voivat vaurioitua. (Tässä tapauksessa ilma poistuu kuivaimen kotelosta lauhduttimen ritilöiden eikä puhaltimen ritilän kautta – tarkista oikea ilmavirtaus kohdista 8.6 ja 8.7). Käännä vaihe välittömästi.

4. Odota viisi minuuttia ja avaa sen jälkeen ilmansyöttöventtiili varovasti.
5. Avaa ilmanpoistoventtiili varovasti. Kuivain suorittaa nyt kuivausta

Vaihevalvonta

Jos kuivaimen käynnistyksen yhteydessä näytössä näkyy hälytys CP, käyttäjän on tarkistettava kuivaimen erotuskytkimen syöttöliittimien kaapelointi.

4.3 Toiminta

- Anna kuivaimen olla toiminnassa koko ajan ilmakompressorin käydessä.
- Koska kuivain toimii automaattitilassa, kenttäasetuksia ei tarvita.
- Jos odottamattomia liiallisia ilmanvirtauksia esiintyy, ohita virtaukset, jotta kuivain ei ylikuormitu.
- Vältä syöttöilman lämpötilan vaihteluita.

4.4 Pysäytys

6. Pysäytä kuivain kahden minuutin kuluttua ilmakompressorin pysähtymisestä tai aina ilmanvirtauksen keskeytyessä.
7. Varmista, että kuivaimeen ei mene paineilmaa silloin, kun kuivain on kytketty irti verkkovirrasta tai hälytystilanteessa.

8. Kytke kuivain pois päältä painikkeella  Painikkeen väri muuttuu harmaaksi .
9. Katkaise virta kiertämällä PÄÄKYTKIN "  " tasentoon 0 OFF.

 Jos kyseessä on vesijäähdytinmalli, sulje vesipiiri kuivain pysäytettynä.

5 Ohjaus

5.1 Perusnäyttö

25/giu/2021 - 11:04:39

LOCAL

FS 0 % HGBV 0 % ECO 0%

0.0 °C PDP

MANUAL DRAIN

Kosketus-painikkeet	Toiminta
	Dryer OFF (musta)
	Dryer ON (vihreänä)

LOCAL = Paikallishjoaus
REMOTE = Etäohjaus

Toiminta	Kosketus-painikkeet	Toiminta
<p>FS 48 %</p> <p>Puhaltimen toiminta-nopeus (vain ilmajähdytinmalli)</p>		Avaa tietovalikon: koneen tila, paineet, lämpötilat, yleiset asetukset, kulutus, käyttäjän salasana
<p>HGBV 14 %</p> <p>Kuumakaasuventtiilin toiminta-nopeus</p>		Harmaa = ei hälytykset Punainen = ilmoitus Punainen vilkkuu = hälytykset
<p>ECO 0%</p> <p>Energiansäästö % (toiminnan aikana)</p>		Kuivain OFF = harmaa valo Pyöräily aktiivinen = vilkkuu vihreänä Kompressorin aktiivinen = vaaleansininen
		harmaa = Lauhteenpoisto OFF vihreä = Lauhteenpoisto ON

Toiminta	Kosketus- painikkeet	Toiminta
<p>Kastepiste-trendi</p> <p>8.0 °C PDP</p>	<p>MANUAL DRAIN</p>	Kosketa: manuaalinen tyhjennys
<p>Функция</p> <p>Strep led:</p> <p>sininen = Kompressorin aktiivinen vihreänä = Energiansäästö Punainen = hälytykset</p>		

5.2 Main menu

Avaa tietovalikko koskettamalla painiketta

Kun painiketta kosketaan, vastaava kehys näkyy korostettuna muutaman sekunnin ajan valinnan vahvistukseksi.

Tämä koskee kaikkia ohjauspaneelin kosketuspainikkeita. Palaa ohjauspaneelille koskettamalla painiketta

OFF

Temperatures

Pressures

Status of I/O

Serial Number

USB Save data

General setting

5.2.1 Koneen tila (I/O)

Avaa koneen tilatietovalikko koskettamalla painiketta

Tuloliitännät ovat seuraavat: Tekstin vieressä oleva LED-valo ilmaisee suojausten/toimintojen/määrittelyjen tilan seuraavasti: aktiivinen = vihreä valo ei aktiivinen = harmaa valo

Siirry seuraavalle sivulle koskettamalla painiketta

Lähtöliitännät ovat seuraavat:

OFF

Status of Input

High pressure switch

Low pressure switch

Thermal protection compressor

Thermal protection fan

Phases sequence control

Dryer remote control

Condensate level 1

Condensate level 2

Condensate level 3

OFF

Status of Output

Plant status ON

General Alarm

Compressor ON

Fan ON

Liquid solenoid valve

Condensate drain 1

Condensate drain 2

Condensate drain 3

Palaa edelliseen valikkoon koskettamalla painiketta

5.2.2 Paine

Koskettamalla painiketta



voit avata painevalikon, joka sisältää seuraavat kohdat: lauhdutuspainne, puhaltimen toimintanopeus, haihdutuspainne, kuumakaasuventtiilin toimintanopeus.

Saat näkyviin komponentin kuvaajan koskettamalla painiketta.

“Lauhdutus-/haihdutuspainne”

Vieritä kuvaajaa painikkeilla



Palaa edelliseen valikkoon koskettamalla painiketta

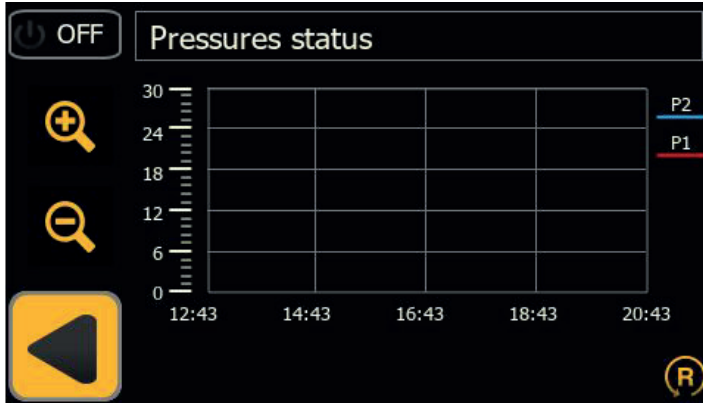
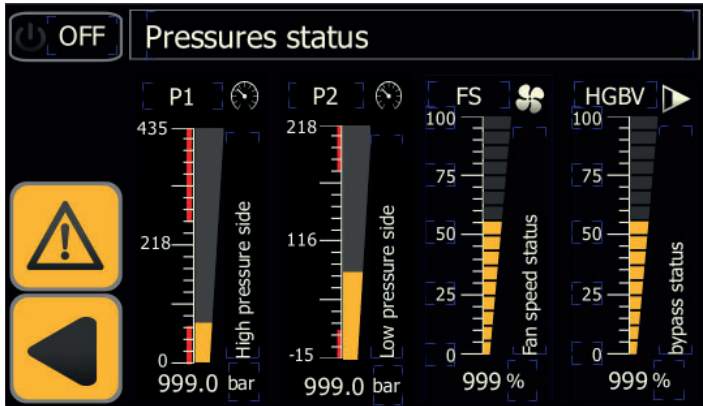

“Kuumakaasuventtiilin/puhaltimen toimintanopeus”

Vieritä kuvaajaa painikkeilla



Palaa edelliseen valikkoon koskettamalla painiketta

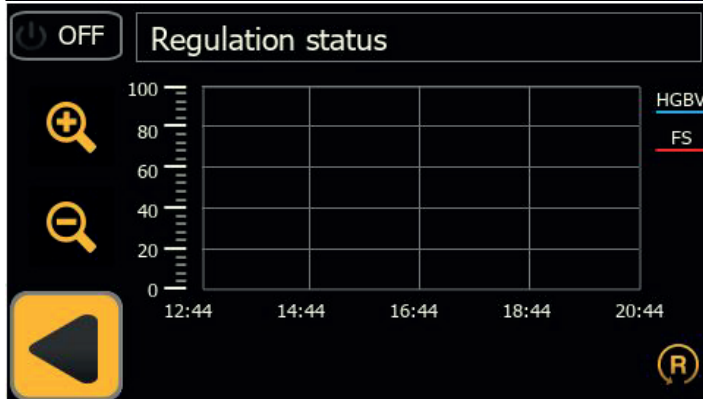

5.2.3 Lämpötila

Painikkeella saat näkyviin piirikaavion lämpötila-antureiden lämpötilan arvot.

Siirry seuraavalle sivulle koskettamalla



painiketta B4 = aktiivinen vain versiolle multicooler.

Koskettamalla jotakin matalan paineen lämpötilan painiketta saat näkyviin matalapainepiirikaavion kaikkien antureiden kuvaajan.

Koskettamalla jotakin korkean paineen lämpötilan painiketta saat näkyviin korkeapainepiirikaavion kaikkien antureiden kuvaajan.

Lämpötila - Low pressure side

Vieritä kuvaajaa painikkeilla



Palaa edelliseen valikkoon koskettamalla painiketta

Lämpötila - High pressure side

Vieritä kuvaajaa painikkeilla



Palaa edelliseen valikkoon koskettamalla painiketta

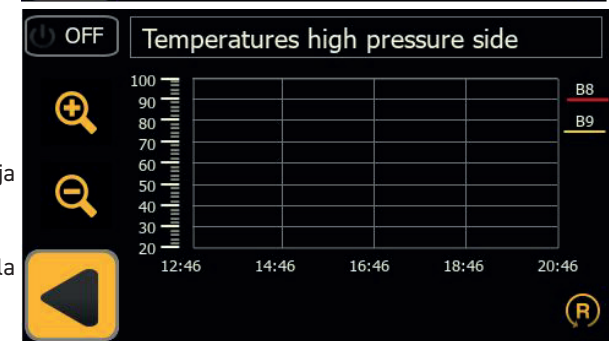
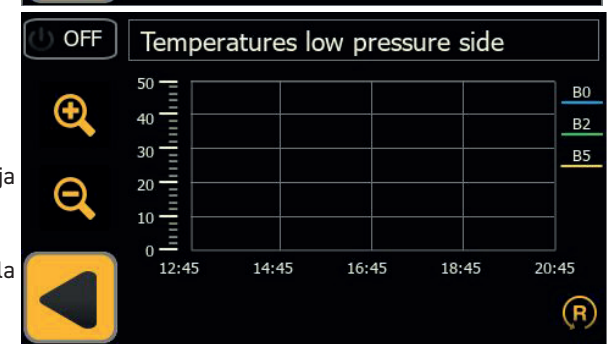
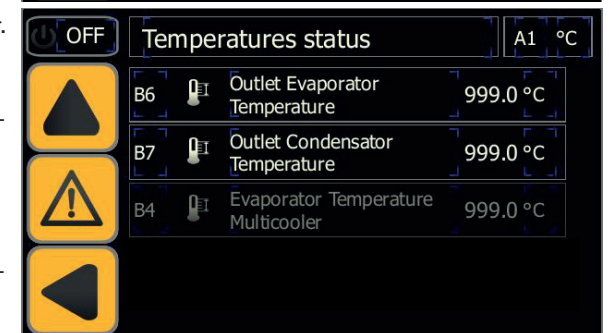
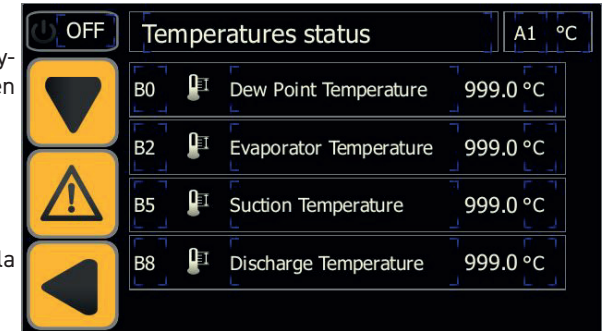

5.2.4 Lataukset

Käytä USB-liitäntää ledillä, joka näyttää latausvaiheen. (8GB alustettuna FAT32:ksi) aseta etupaneeliin.

Koskettamalla painiketta  käynnistääksesi latauksen. Tietojen latausaika riippuu tallennettujen tietojen määrästä.

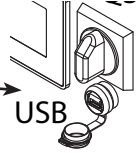

5.2.5 Sarjanumeron päivämäärä

Avaa "serial number" valikko koskettamalla painiketta

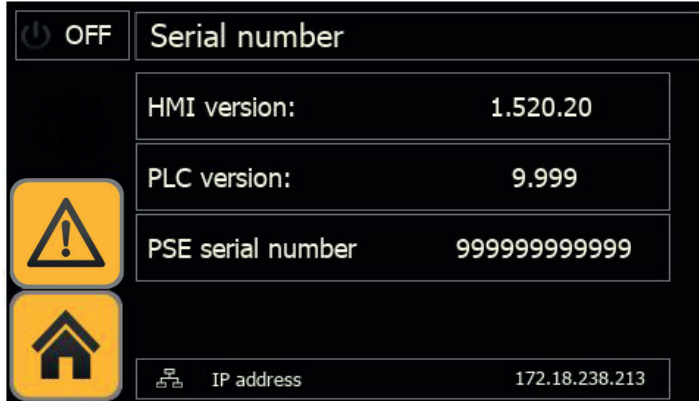

Serial number

HMI version:	1.520.20
PLC version:	9.999
PSE serial number	999999999999
IP address	172.18.238.213

Palaa ohjauspaneelille koskettamalla painiketta 

5.2.6 Yleistiedot

Koskettamalla painiketta

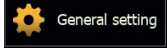

voit avata yleistietojen valikon, joka sisältää seuraavat kohdat: kieli, päivämäärä/aika, parametri, huolto, jaksottainen/jatkuva toiminta.

Avaa valikko kosketuspainikkeella.

Palaa ohjauspaneelille koskettamalla painiketta

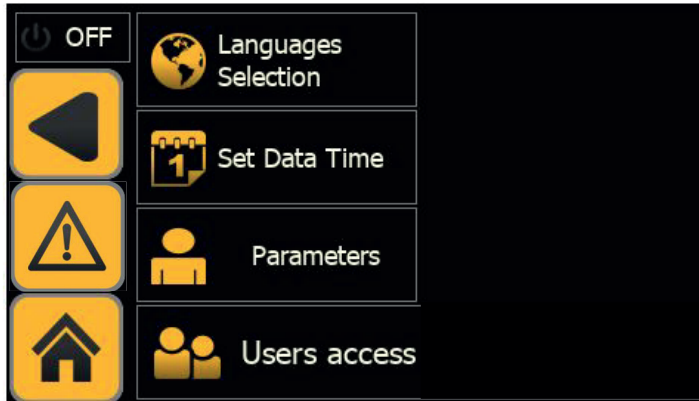

General setting

- Languages Selection
- Set Data Time
- Parameters
- Users access

5.2.6.1 Kieli

Avaa kielivalikko koskettamalla



painiketta

Kosketa haluamaasi kieltä. Päävalikko avautuu automaattisesti valitulla kielellä.

Palaa edelliseen valikkoon koskettamalla painiketta 

Kosketa haluamaasi kieltä. Päävalikko avautuu automaattisesti valitulla kielellä.

Palaa edelliseen valikkoon koskettamalla painiketta 



OFF

English Italian German

Czech Polish Slovak



OFF

French Spanish Swedish

Russian Dutch Portuguese

5.2.6.2 Päivämäärä/aika

Avaa päivämäärän ja ajan valikko koskettamalla painiketta



Vaihda päivämäärää/aikaa koskettamalla vastaavia painikkeitä

Vahvista painamalla 2 sekuntia



Palaa edelliseen valikkoon koskettamalla painiketta 

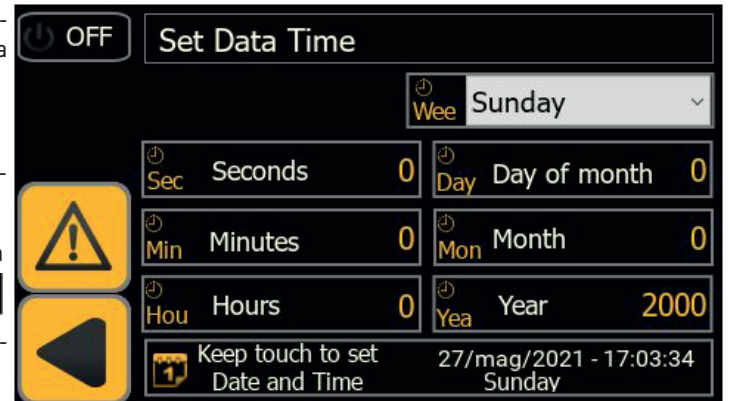

Set Data Time

Week Sunday

Sec	Seconds	0	Day	Day of month	0
Min	Minutes	0	Mon	Month	0
Hou	Hours	0	Yea	Year	2000

Keep touch to set Date and Time 27/mag/2021 - 17:03:34 Sunday

5.2.6.3 Käyttäjälvalikko

Käyttäjälvalikko valikko koskettamalla painiketta

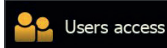

Tämä valikko on varattu Parker-huoltoteknikolle.

User name:

Password:

Show password

5.2.6.4 Parametri

Avaa parametrien valikko koskettamalla painiketta

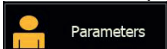

Valikko sisältää seuraavat kohdat: anturit, lauhteenpoisto, määrittely, huolto, jaksot.

Avaa valikko kosketuspainikkeella.

Palaa edelliseen valikkoon koskettamalla painiketta



Anturit

Aseta varoitukset ja viiveet tai kastepisteen minimi-/maksimi-arvo koskettamalla painiketta

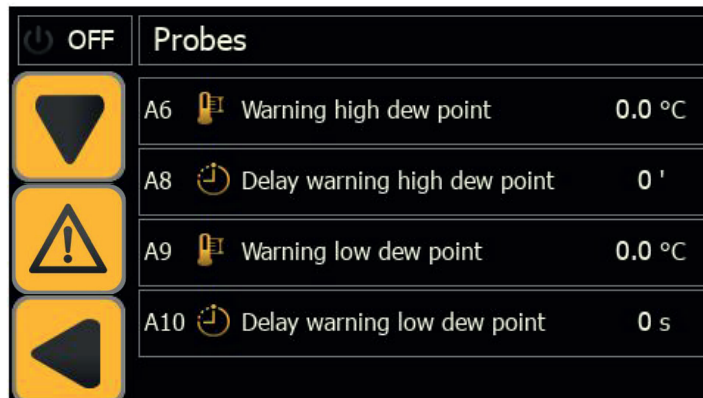
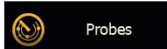

Lauhteenpoisto

Avaa lauhteenpoistovalikko koskettamalla painiketta

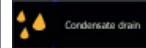

Vaihtoehdot:

1. Ajustettu tyhjennys (valitse suljenta- ja avausajat)
2. Kapasitiivinen tyhjennys
3. Jatkuva tyhjennys (ulkoisen poisto).

Palaa edelliseen valikkoon koskettamalla painiketta



Määrittely

Painikkeella voit avata määrittelyvalikon, joka sisältää seuraavat vaihtoehdot:

1. Lämpötilan yksikkö C° / F°
2. Etäohjauksen käyttöönotto
3. Vain hälytysten tai hälytysten/varoitusten käyttöönotto
4. Asetusten palautus oletusarvoihin.

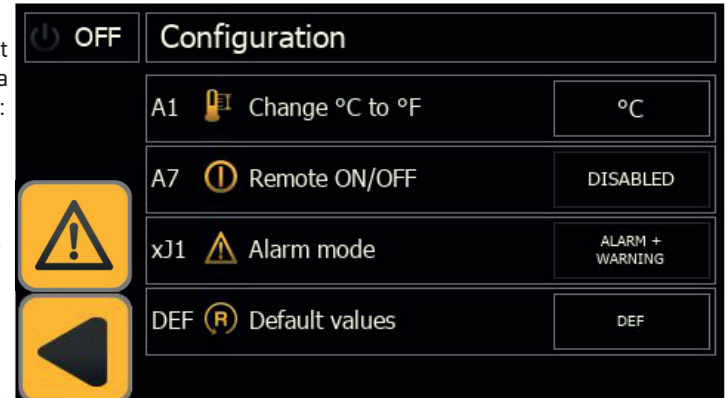



Tee valinta koskettamalla tekstin vieressä olevaa painiketta.

Voit hallita REMOTE OFF -tilaa poistamalla liittimien välisen sillan: 87 -GND ja kytkemällä etäkäynnistys-/pysäytyskytkimen (asiakkaan on toimitettava).

Huolto

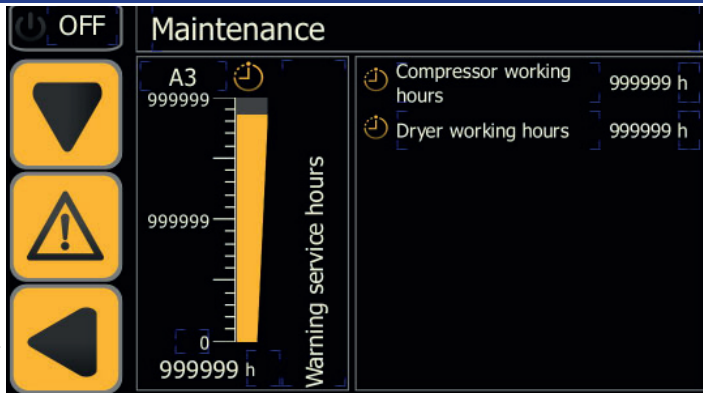
Painikkeella  saat näkyviin kompressorin/kuivaimen toimintatunnit.



Palaa edelliseen valikkoon koskettamalla painiketta .

Toiminta

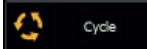
Valitse toimintatapa koskettamalla painiketta  atkuva, jaksottainen (energiaa säästävä).

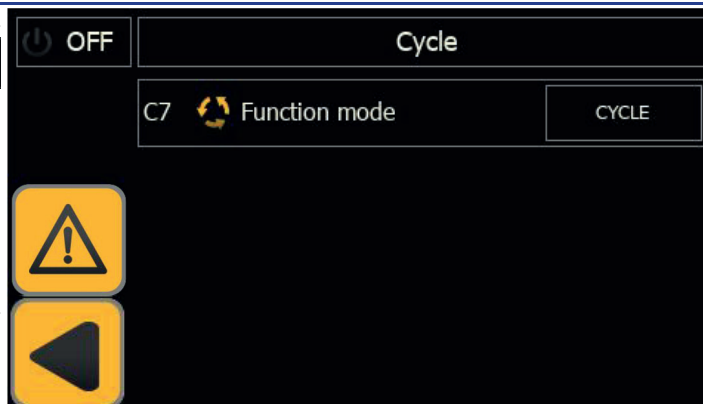



Tämä vaihtoehto on käynnissä.

Palaa edelliseen valikkoon koskettamalla painiketta .

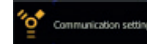
Modbus

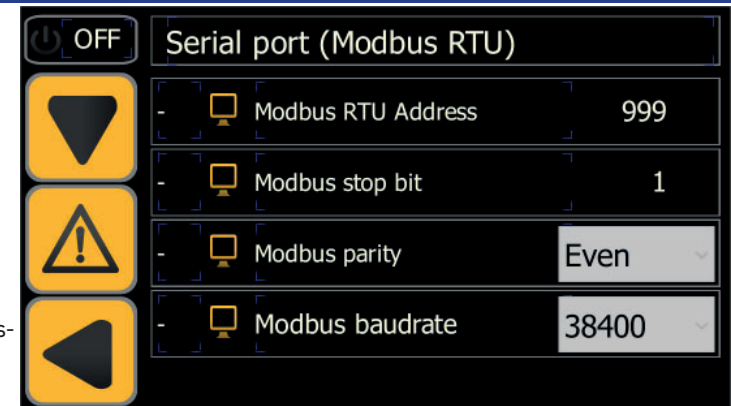
Painikkeella  tasettaa Modbus-parametrit. MODBUS RTU (RS485)



Siirry seuraavalle sivulle koskettamalla painiketta  MODBUS TCP/IP

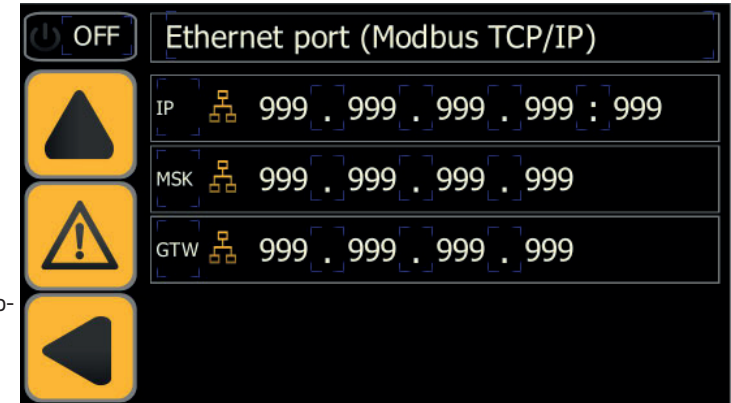



Palaa edelliseen valikkoon koskettamalla painiketta .

Vahvista asetukset kytkemällä kuivausrumpu pois päältä/päälle.

Cloud

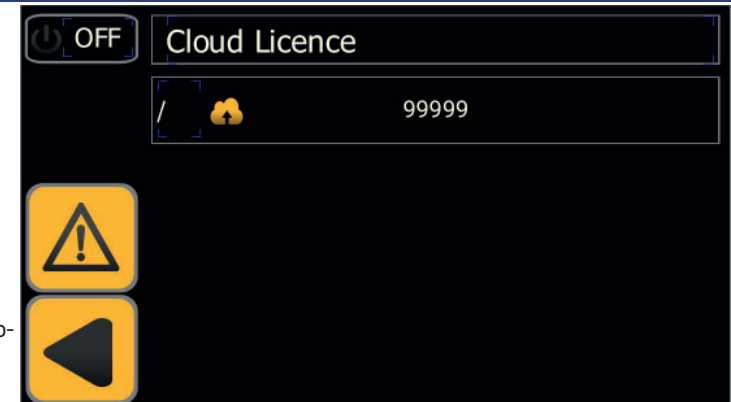
Painikkeella  jnähä "password" cloud.



Palaa edelliseen valikkoon koskettamalla painiketta .

5.3 Hälytykset/varoitukset

Avaa hälytysten/varoitusten valikko koskettamalla paini-



ketta

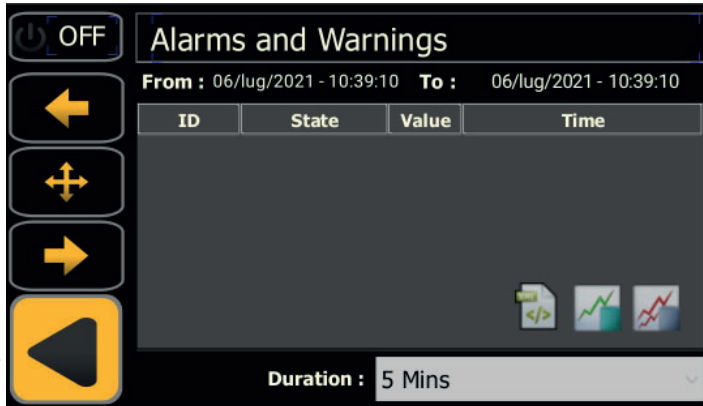

Kosketa "duration" vaihtaa-
sesi tutkimuksen aikaa.

Kun normaalit olosuhteet on palautettu, jotkin varoitukset ja hälytykset kuittaautuvat automaattisesti, mutta jotkin on kuitattava manuaalisesti.

Kuittaa hälytys painikkeella

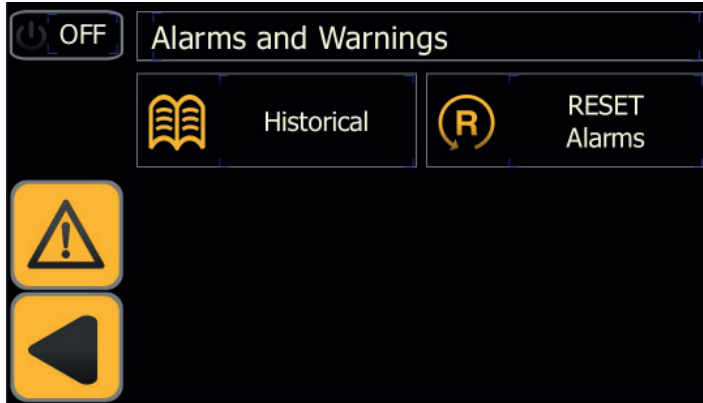

Painikkeella
saat näkyviin aikaisemmat
hälytykset, joista on olemassa
seuraavat tiedot:

hälytyskoodi, päivämäärä,
hälytysten määrä, esiinty-
misjärjestys sekä hälytyksen
aktivoitumisaika.

Palaa edelliseen valikkoon koskettamalla painiketta



5.3.1 Hälytysten/varoitusten luettelo

a = hälytys; w = varoitus.



Koodi	hälytys/varoitus	Syy
aLD	matalan kastepisteen hälytys	lämpötila B0<A9 yli A10 sekuntia
aLT	haiduttimen alhaisen lämpötilan hälytys	lämpötila B2<A12 yli A13 sekuntia
aHT2	lauhteenpoiston korkean lämpötilan hälytys	lämpötila B8>A11
aHP	korkean paineen hälytys	korkean paineen kytkin lauennut
aLP	alhaisen lämpötilan hälytys	alhaisen lämpötilan kytkin lauennut
aLTA	jäähdyttimen alhaisen lämpötilan hälytys	lämpötila B4<A12 yli A13 sekuntia
aPI*	kompressorin lämpösuoja hälytys	kompressorin lämpösuoja lauennut
aPH	vaihevalvonnan hälytys	vaihevalvonnan rele lauennut (vain 460-750)
aCM1	tietoliikenteen laajennuksen 1 hälytys	laajennus 1 ei yhteydessä
aCM2	tietoliikenteen laajennuksen 2 hälytys	laajennus 2 ei yhteydessä
wB0	anturin B0 varoitus	anturi vioittunut tai huono kytkentä
wB2	anturin B2 varoitus	anturi vioittunut tai huono kytkentä
wB4	anturin B4 varoitus	anturi vioittunut tai huono kytkentä
wB5	anturin B5 varoitus	anturi vioittunut tai huono kytkentä
wB6	anturin B6 varoitus	anturi vioittunut tai huono kytkentä
wB8	anturin B8 varoitus	anturi vioittunut tai huono kytkentä
aFP1	korkeapainelähtetimen P1 hälytys	lähtetin vioittunut tai huono kytkentä
wHD	korkean kastepisteen varoitus	lämpötila B0>A6 yli A8 minuuttia
wHT1	lauhteenpoiston korkean lämpötilan varoitus	lämpötila B8>A14 yli A15 minuuttia
wHP1	korkean paineen varoitus	paine P1>A16 yli 2 sekuntia
wHB5	korkean imulämpötilan varoitus	lämpötila B5>A18 yli minuutin
wLP2	matalan paineen varoitus	paine P2>A21 yli 150 sekuntia
wSR	määräaikaishuollon varoitus	huoltoaika ohitettu
wDR1	tyhjennyksen 1 varoitus	lauhde ei poistu jäähdyttimestä 1
wDR2	tyhjennyksen 2 varoitus	lauhde ei poistu jäähdyttimestä 2
wDR3	tyhjennyksen 3 varoitus	lauhde ei poistu jäähdyttimestä 3
aFP2	matalapainelähtetimen P2 hälytys	lähtetin vioittunut tai huono kytkentä

* malleissa 900-1800 hälytyksellä voi olla myös käännteisten vaiheiden merkitys.

5.4 Pikavalikko

Valikon avaaminen nopeasti:



Lämpötilan tarkistaminen

Kosketa painiketta  → Kosketa painiketta  Näytä kuvaajat koskettamalla lämpötilaa.

Paineen tarkistaminen

Kosketa painiketta  → Kosketa painiketta  Näytä kuvaajat koskettamalla painetta.



Lataukset

Kosketa painiketta  → Aloita lataus koskettamalla painiketta 



Sarjanumeron päivämäärä

Kosketa painiketta  → Kosketa painiketta 

Kielen vaihtaminen

Kosketa painiketta  → Kosketa painiketta  → Kosketa painiketta  valitse kieli.

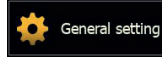
Päivämäärä/aika

Kosketa painiketta  → Kosketa painiketta  → Kosketa painiketta  Kellon asettaminen aikaan



Lämpötilan yksikön vaihtaminen välillä C° ja F, Remote, DEF

Kosketa painiketta  → Kosketa painiketta  → Kosketa painiketta 
→ Kosketa painiketta  :
Tee muutos koskettamalla parametria "°C" tai "°F".
Ota käyttöön / poista käytöstä parametri "Remote ON/OFF".
Palauta parametri koskettamalla "DEF".

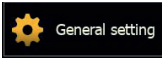

Vaihto jaksottaiseen toimintaan

Kosketa painiketta  → Kosketa painiketta  → Kosketa painiketta 
→ Kosketa painiketta  Vaihda toimintaa.

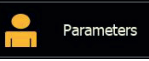
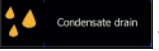
Tyhjennys

Kosketa painiketta  → Kosketa painiketta  → Kosketa painiketta 
→ Kosketa painiketta  Valitse haluamasi tyhjennys.

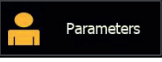

Modbus

Kosketa painiketta  → Kosketa painiketta  → Kosketa painiketta 
→ Kosketa painiketta 

Parametrien asettaminen

Kosketa painiketta  → Kosketa painiketta  → Kosketa painiketta 
→ Kosketa painiketta  Parametrien asettaminen.

Hälytys/varoitus

Kosketa painiketta  → Kosketa painiketta  historiallisen hälytyksen löytämiseksi ja hälytyksen kuittaamiseksi.

Kosketa painiketta  nähdäksesi historiallisen hälytyksesi.

Kuittaa hälytys painikkeell 

6 Huolto

• Kuivain on suunniteltu ja valmistettu jatkuvatoimiseksi. Komponenttien käyttöikä riippuu kuitenkin huoltotoimenpiteiden suorittamisesta.

-  Z Kun tilaat huollon tai varaosia, ilmoita kuivaimen malli ja sarjanumero, jotka on merkitty yksikköön kiinnitettyyn tyyppikilpeen.
- Piireistä, jotka sisältävät 5t < xx < 50t CO2, on tarkistettava mahdolliset vuodot vähintään kerran vuodessa.
Piireistä, jotka sisältävät 50t < xx < 500t CO2, on tarkistettava mahdolliset vuodot vähintään puolen vuoden välein ((EU) n:o 517/2014 art. 4.3.a, 4.3.b).
- Kuivaimista, jotka sisältävät vähintään 5t CO2, käyttäjän tulee kirjata muistiin käytettävän kylmäaineen määrä ja tyyppi sekä lisätyt ja huoltotöiden, korjausten ja lopullisen käytöstäpoiston aikana talteenotetut määrät ((EU) n:o 517/2014 art. 6).

6.1 Yleisiä varoituksia

 Tarkista seuraavat asiat aina ennen huoltotöiden aloittamista:

- Pneumatiikkapiiristä on poistettu paine.
- Skuivain on kytketty irti verkkovirrasta.

 Käytä aina valmistajan alkuperäisiä varaosia: muussa tapauksessa valmistaja vapautuu kaikesta vastuusta koneen toimintahäiriöistä.

 Jos jäähdytysnestettä vuotaa ulos, ota yhteys ammattitaitoiseen ja valtuutettuun henkilöstöön.

 Schrader-venttiiliä saa käyttää vain laitteen toimintahäiriöiden yhteydessä. Muussa tapauksessa takuu ei vastaa jäähdytysaineen väärin suoritettua lisäyksen aiheuttamista vaurioista.

6.2 Jäähdytysaine

Jäähdytysaineen täyttö: takuu ei vastaa mahdollisista vaurioista, jotka ovat aiheutuneet asiantuntemattoman henkilöstön suorittaman jäähdytysaineen täytön vuoksi. 







 Laitte sisältää fluorattuja kasviuonekaasuja.

Jäähdytysneste R513A on normaalissa lämpötilassa ja paineessa väritön kaasu, joka kuuluu SAFETY GROUP A1 - EN378 (ryhmän 2 neste direktiivin PED 2014/68/EU) mukaisesti; GWP (maapallon lämpenemisen yksikkönä käytettävä lämmityspotentiaali) = 573.

 Jos jäähdytysnestettä vuotaa ulos, tuuleta tila.

6.3 Ennaltaehkäisevä huolto-ohjelma

Suorita seuraavassa mainitut ennakoivat huoltotoimenpiteet varmistaaksesi kuivaimen tehokkaan ja luotettavan toiminnan:



Huoltotoimenpiteenkuvaus	Huoltoväli (normaaleissa käyttöolosuhteissa)				
	Päivittäin	Viikottain	4 kk välein	12 kk välein	36 kk välein
Toimenpide tarkistus  huolto 					
Tarkista, että POWER ON -merkkivalo palaa.					
Tarkista ohjauspaneelin merkkivalot.					
Puhdista Veden paineventtiili suodatin, jos se ei ole likainen, pidennä tarkastusväliä (katso ohjeet) (PSE750-1800)					
Tarkista lauhteenpoistin.					
Puhdista kondensaattorin siivet.					
Tarkista kampikammion lämmitysvastuksen oikea sijainti.					
Tarkista sähköinen tehonotto.					
Tarkista jäähdytysaineen vuodot.					
Poista paine järjestelmästä. Suorita lauhteenpoistimen huolto.					
Poista paine järjestelmästä. Vaihda esi- ja jälkisuodattimet.					
Tarkista lämpötila-anturit. Vaihda tarvittaessa.				 	
Kuivaimen huoltovälinesarja.					

Saatavilla on seuraavat varaosasarjat (katso Kappale 9.4):

- 3 vuoden ennakkohuollon tarvikkeet;
- huoltotarvikkeet:
 - kompressorin varaosasarja;
 - puhaltimen varaosasarja;
 - kuumakaasuventtiilien tarvikkeet;
 - kondensaattorin tarvikkeet;
- yksittäiset varaosat.

6.4 äteöljyn ja -nesteiden hävittäminen

Laitteen putkistoissa kiertävä jäähdytysneste ja voiteluöljy on otettava talteen paikallisten ympäristömääräysten mukaisesti. Jäähdytysnesteen talteenotto suoritetaan ennen laitteiston lopullista romuttamista ((EU) n:o 517/2014 art. 8).

	Kierrätys Jätehuolto 
runko-osat	teräs/epoksi-polyesteriliima
lämmönsiirrin	alumiini
putkistot/jakoputket	kupari/alumiini/hiiliteräs
lauhteenpoistin	polyamidi
lämmönsiirtimen eristys	EPS (sintrattu polystyreeni)
putkistojen eristys	synteettinen kumi
kompressori	teräs/kupari/alumiini/öljy
kondensaattori	teräs/kupari/alumiini
jäähdytysneste	R513A
venttiilit	messinki
sähkökaapelit	kupari/PVC

Sähkökomponentteja sisältävät laitteet on hävitettävä erikseen sähkö- ja elektroniikkajätteen mukana paikallisen ja voimassa olevan lainsäädännön mukaisesti.



7 Vianetsintä

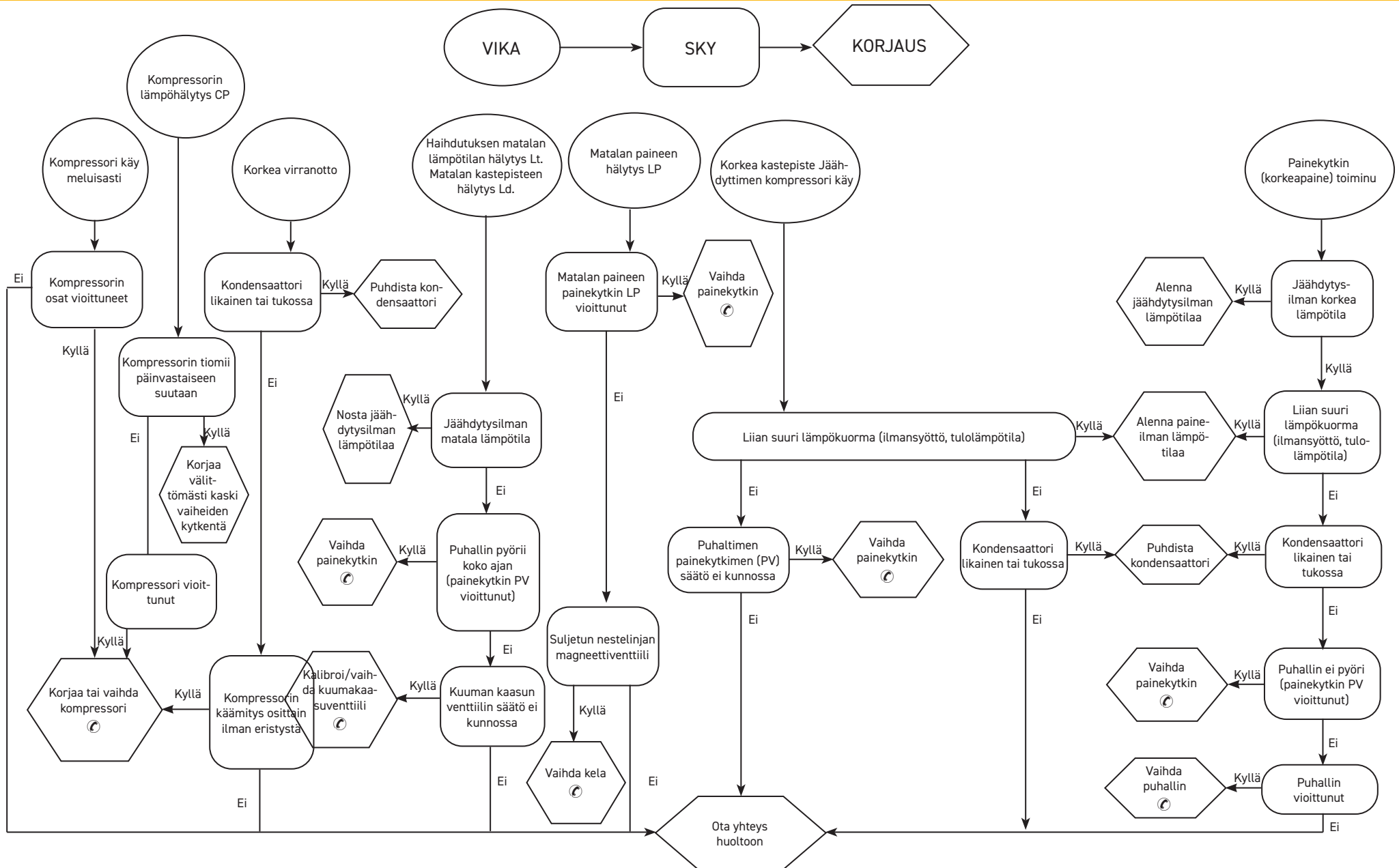

Appendice
Appendix
Apéndice
Appendice
Anhang
Anexo
Bilaga
Liittet
Bijlage
Příloha
Приложение
Dodatok

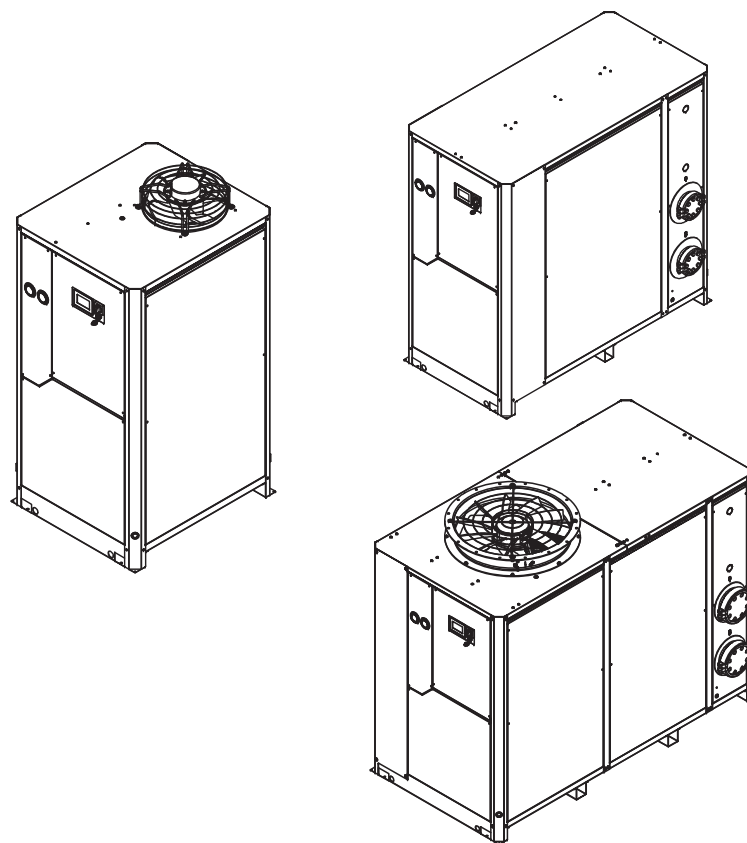

CONTENTS

8.1 LEGEND	pag. 2
8.2 INSTALLATION DIAGRAM	pag. 5
8.3 TECHNICAL DATA	pag. 7
8.4 SPARE PARTS	pag. 8
8.5 EXPLODED DRAWING	pag. 10
8.6 DIMENSIONAL DRAWING	pag. 16
8.7 REFRIGERANT CIRCUIT	pag. 26
8.8 WIRING DIAGRAM	pag. 28

8.1 LEGEND

Symbol	IT/EN/ES/FR/DE/PT/SV/SU/NL/CS/RU/ SK	Symbol	IT/EN/ES/FR/DE/PT/SV/SU/NL/CS/RU/ SK	Symbol	IT/EN/ES/FR/DE/PT/SV/SU/NL/CS/RU/ SK
	Peso/ Weight / Peso/ Poids / Gewicht / Peso / Vikt / Paino / Gewicht / Váha / Bec / Hmotnosť /		Uscita aria compressa / Compressed air outlet / Salida aire comprimido / Sortie air comprimé / Druckluftaustritt / Saída de ar comprimido / Tryckluftsutlopp / Paineilman poisto / Uitgang perslucht / Výstup stlačeného vzduchu / Выход сжатого воздуха / Výstup stlačeného vzduchu		Uscita acqua di condensazione / Condensation water outlet / Salida agua de condensación / Sortie eau de condensation / Auslauf Kühlwasser / Saída de água de condensação / Utlopp för kondensvatten / Lauhdeilman poisto / Uitgang condenswater / Výstup kondenzátu / Выход конденсационной воды / Prívod kondenzačnej vody
	Temperatura ambiente / Ambient temperature / Temperatura ambiente / Température Ambiente / Umgebungstemperatur / Temperatura ambiente / Omgivningstemperatur / Ympäristön lämpötila / Omgevingstemperatuur / Teplota prostředí / Температура окружающей среды / Teplota prostredia		Ingresso acqua di condensazione / Condensation water inlet / Entrada agua de condensación / Entrée eau de condensation / Einlauf Kondensationswasser / Entrada de água de condensação / Kondensvattenintag / Lauhdeilman syöttö / Ingang condenswater / Vstup kondenzátu / Вход конденсационной воды / Prívod kondenzačnej vody		Ingresso aria di condensazione / Condensation air inlet / Entrada aire de condensación / Entrée air de condensation / Eintritt Kühlluft / Entrada do ar de condensação / Intag för kondensluft / Lauhdeilman syöttö / Ingang condenslucht / Vstup kondenzovaného vzduchu / Вход конденсационного воздуха / Prívod kondenzovaného vzduchu
	Durante trasporto & immagazzinaggio / During transport and stockage / Durante transporte y almacenaje / Pendant le transport et le stockage / Während Transport & Lagerung / Durante o transporte e armazenagem / Under transport och magasinering / Kuljetuksen ja varastoinnin aikana / Tijdens transport & opslag / Bøhem dopravy a skladování / Во время транспортировки и хранения / Počas prepravy a skladovania		Uscita acqua di condensazione / Condensation water outlet / Salida agua de condensación / Sortie eau de condensation / Auslauf Kühlwasser / Saída de água de condensação / Utlopp för kondensvatten / Lauhdeilman poisto / Uitgang condenswater / Výstup kondenzátu / Выход конденсационной воды / Prívod kondenzačnej vody		Allarme generale / General alarm / Alarma general / Alarme générale / Allgemeiner Alarm / Alarma geral / Allmänt larm / Yleishälytys / Algemeen alarm / Obecný poplach / Общaя аварийна сигнализация / Všeobecný alarm
	Dopo l'installazione / After installation / Después de la instalación / Après l'installation / Nach der Installation / Após a instalação / Efter installationen / Asennuksen jälkeen / Na installatie / Po instalaci / После установки / Po inštaláci		Valori di taratura / Calibration values / Valores de calibración / Valeurs de réglage / Einstellwerte / Valores de calibragem / Installningsvärden / Säätöarvot / Instelwaarden / Hodnoty kalibrace / Величины настройки / Hodnoty kalibrácie		Opzionale / Optional / Opcional / Option / Optional / Opcional / Tillval / Valinnainen / Optioneel / Volitelné / Опция / Volitelné
	Massima pressione di esercizio lato aria / Air-side max. working pressure / Presión máxima de trabajo lado aire / Pression maximum d'utilisation côté air / Max. Betriebsdruck auf Druckluftseite / Pressão máxima de funcionamento do lado do ar / Maximalt drifttryck på luftsidan / Maksimi toimintapaine ilman puolella / Maximale bedrijfstemperatuur luchtzijde / Maximální provozní tlak strana vzduchu / Максимальное рабочее давление воздуха / Maximálny pracovný tlak na strane vzduchu		Ingresso alimentazione elettrica / Electrical supply inlet / Entrada alimentación eléctrica / Entrée alimentation électrique / Eingang elektrische Versorgung / Entrada da alimentação eléctrica / Intag för strömförsörjning / Sähkönsyöttö / Ingang elektrische voeding / Vstup elektrického napájení / Вход электропитания / Vstup elektrického napájania		Compressore / Compressor / Compresor / Compresseur / Verdichter / Compressor / Kompressor / Kompresori / Compressor / Kompresor / Компрессор / Kompresor
	Temperatura ingresso aria compressa / Compressed air inlet temperature / Temperatura entrada aire comprimido / Température entrée air comprimé / Temperatur am Drucklufteintritt / Temperatura de entrada do ar comprimido / Temperatur på tryckluften vid intaget / Paineilman tulolämpötila / Inlaattemperatuur perslucht / Teplota vstupu stlačeného vzduchu / Температура сжатого воздуха на входе / Teplota na vstupe stlačeného vzduchu		Scarico condensata / Condensate drain / Drenaje de condensados / Purge des condensats / Kondensatablass / Descarga da condensação / Kondensavlednin / Lauhteenpoisto / Afvoer condens / Odvod kondenzátu / Слив конденсата / Odvod kondenzátu		Condensatore refrigerante / Refrigerant condenser / Condensador refrigerante / Condenseur réfrigérant / Kältemittel Verflüssiger / Condensador refrigerante / Kylkondensator / Jäähdytyskondensattori / Condensator koelvloeistof / Kondenzátor chladivo / Конденсатор хладагента / Kondenzátor chladiva
	Sezione minima cavo omologato per collegamento elettrico / Minimum section validated cable for electrical connection. / Sección mínima cable homologado para conexión eléctrica / Section minimale câble homologué pour le raccordement électrique. / Mindestquerschnitt des typengeprüften Kabels für elektrischen Anschluss / Secção mínima do cabo homologado para a ligação eléctrica. / Minsta tvärsnitt för godkänd kabel för elektrisk anslutning. / Sähköliittännän hyväksytyn kaapelin minimihalkaisija. / Minimumdoorsnede goedgekeurde kabel voor elektrische aansluitingen. / Minimální průřez homologovaného kabelu pro připojení k elektrické síti / Минимальное сечение кабеля одобренного типа для выполнения электрических соединений / Minimálny prierez homologovaného kábla elektrického zapojenia		Límite dell'apparecchiatura / Limit of equipmen / Límite del equipo / Limite de l'appareil / Grenze der Einheit / Limite do aparelho / Apparatus gräns / Laitteiston raja / Limieten van de apparatuur / Limit zařízení / Граница оборудования / Hranica zariadenia		Elettroventilatore / Fan motor / Electroventilador / Électroventilateur / Elektroventilator / Ventilador eléctrico / Elfläkt / Sähköpuhallin / Elektroventilator / Elektrický ventilátor / Электровентилятор / Elektrický ventilátor
	Ingresso aria compressa / Compressed air inlet / Entrada aire comprimido / Entrée air comprimé / Drucklufteintritt / Entrada de ar comprimido / Tryckluftsintag / Paineilman syöttö / Ingang perslucht / Vstup stlačeného vzduchu / Вход сжатого воздуха / Vstup stlačeného vzduchu		Livello pressione sonora (a 1 m di distanza in campo libero, secondo norma ISO 3746) / Sound pressure level (1m distance in free field - according to ISO 3746). / Nivel de presión sonora (a 1 m de distancia in campo libre, según norma ISO 3746) / Niveau de pression sonore à 1 mètre de distance en champ libre (selon norme ISO 3746) / Schalldruckpegel (in 1 m Abstand auf freiem Feld) (gemäß ISO-Norm 3746). / Nivel de pressão sonora (a 1 metro de distância em campo aberto (segundo a norma ISO 3746). / Ljudtrycksnivå (på 1 meters avstånd, i fritt fält (enligt standard ISO 3746). / Aänenpainetas (metrin etäisyydellä vapaassa tilassa, standardin ISO 3746 mukaisesti). / Geluidsniveau (op 1 meter afstand in het vrije veld (volgens norm ISO 3746). / Hladina zvukového tlaku (ve vzdálenosti 1 m ve volném prostoru, podle normy ISO 3746). / Уровень звукового давления (на расстоянии 1 метра в свободном пространстве, согласно норме ISO 3746) / Hladina akustického tlaku (vo vzdialenosti 1 meter vo voľnom poli - podľa normy ISO 3746)		Elettrovalvola linea di liquido / Liquid line solenoid valve / Electroválvula línea de líquido / Électrovanne ligne de liquide / Magnetventil Flüssigkeitsleitung / Solenoïde de linha de líquido / Magnetventil för vätskelinej / Nestelinjan magneettiventtiili / Elektromagnetische klep vloeistoflijn / Elektrický ventil vedení kapaliny / Электромеханический клапан жидкостной систем / Kvapalinová linka solenoidného ventilu
					Capillare espansione / Expansion capillary / Capillar expansión / Tube de détente / Kapillarrohr / Tubo de expansão / Expansionskapillarrör / Paisuntaputki / Expansieleiding / Expanzní kapilára / Расширительный капилляр / Expanzná kapilára
					Evaporatore / Evaporator / Evaporador / Évaporateur / Verdampfer / Evaporador / Förångare / Haihdutin / Verdampfer / Výparník / Испаритель / Výparník
					Trasduttore bassa pressione/ Low pressure transmitter/ Transmisor de baja presión/ Transmetteur basse pression/ NiederDrucktransduktor/ Transmissor de baixa pressão/ Lågtrycks sändare/ Lage druktransmitter/ nízký tlak Převodník/ Передатчик низкого давления/ Vysielač nízkého tlaku

8.1 LEGEND

Symbol	IT/EN/ES/FR/DE/PT/SV/SU/NL/CS/RU/ SK	Symbol	IT/EN/ES/FR/DE/PT/SV/SU/NL/CS/RU/ SK	Symbol	IT/EN/ES/FR/DE/PT/SV/SU/NL/CS/RU/ SK
⑨	Presa di pressione / Pressure point / Toma de presión / Prise de pression / Druckanschluss / Tomada de pressão / Tryckuttag / Imupaine / Drukafnamepunt / Mjüci hrdlo tlaku / Контрольная точка измерения давления / Tlakový bod	⑮	Elettrovalvola scarico condensa / Condensate drain solenoid valve / Electroválvula drenaje condensados / Électrovanne décharge condensats / Magnetventil Kondensatablass / Solenóide de descarga da condensação / Magnetventil för kondensavledning / Lauhteenpoiston magneettiventtiili / Elektromagnetische klep condensafvoer / Škřidruha separatory / Elektrický ventil odvodu kondenzátu / Электроклапан системы слива конденсата / Solenoidný ventil odtoku kondenzátu	B5	Sensore temperatura aspirazione / Suction temperature sensor / Sensor temperatura entrada refrigerante / Capteur de température aspiration réfrigérant / Temperatursensor Kältemittel Saugseite / Sensor da temperatura do aspiração de refrigerante / Sugtemperaturgivare / Jäähdytysaineen syötön lämpötilasensori / Temperatuursensor aanzuiging koelvlloeistof / Čidlo teploty nasávaní chladiva / Датчик температуры всасывания хладагента / Teplotný snímač sania
⑩	Manometro aspirazione refrigerante/ Refrigerant suction manometer/ Manómetro entrada refrigerante/ Manomètre aspiration réfrigérant/ Manometer auf Kältemittel Saugseite/ Manómetro de aspiração de refrigerante/ Kylvätskeintloppsmanometer/ Manometer aanzuiging koelmiddel/ Tlakoměr nasávaní chladiva/ Манометр системы всасывания хладагента/ Manometer sania chladiva	⑳	Sensore di livello / Condensate level sensor / Sensor de nivel / Capteur de niveau / Füllstandsensor / Sensor do nível / Nivågivare / Pintasensori / Niveausensor / ěidlo hladiny kondenzátu / Датчик уровня / Snímač hladiny kondenzátu	B8	Sensore temperatura mandata refrigerante / Discharge temperature sensor / Sensor temperatura salida refrigerante / Capteur de température départ réfrigérant / Temperatursensor Kältemittelvorlauf / Sensor da temperatura do caudal de refrigerante / Givare för det tillförda kylmedlets temperatur / Jäähdytysaineen syötön lämpötilasensori / Temperatuursensor drukzijde koelvlloeistof / Čidlo teploty výtlaku chladiva / Датчик температуры подачи хладагента / Teplotný snímač výtlaku
⑪	Pressostato bassa pressione / Low pressure switch / Presostato baja presión / Pressostat basse pression / Niederdruckwächter / Pressóstato de baixa pressão / Lågtrycksvakt / Matalapaineen painekytin / Lagedruckschakelaar / Presostat nízký tlak / Реле низкого давления / Spínač nízkého tlaku	㉔	Valvola pressostatica acqua / Water pressostatic valve / Válvula presostática agua / Valve pressostatique eau / Druckgeregeltes Ventil für Wasser / Válvula pressostática da água / Tryckvaktsventil för vatten / Veden paineventtiili / Drukgestuurde klep water / Presostatický ventil voda / Клапан регулирования давления воды / Ventil so snímačom tlaku vody	DR	Scaricatore di condensa elettronico / Electronic condensate drain / Drenaje de condensados electrónico / Purgeur de condensats électronique / Elektronische Kondensatablassvorrichtung / Descarregador de condensação electrónico / Elektronisk kondensavledare / Elektroninen lauhteenpoistin / Elektronische condensafvoerinrichting / Elektronický odváděč kondenzátu / Электронный конденсатоотводчик / Elektronický odtok kondenzátu
⑫	Valvola gas caldo / Hot gas valve / Válvula gas caliente / Vanne gas valve / Heißgasventil / Válvula de gás quente / Varmgasventil / Kuuman kaasun venttiili / Heetgasklep / Ventil horkého plynu / Клапан горячего газа / Indikátor rosného bodu	F.1/ F.2/F.3 ..	Pannelli / Panels / Paneles / Panneaux / Gehäuseteile / Painéis / Panele / Paneelit / Panelen / Panely / Панели / Panely	EH1	Resistenza carter / Crankcase heater / Resistencia cárter / Résistance carter / Kurbelwannenheizung / Resistência cárter / Vevhuvärmare / Kampikammion lämmitin / Carterweerstand / Topení vany klikové skříně / Нагреватель корпуса / Ohrievač klukovej skrine
⑬	Pressostato alta pressione / High pressure switch / Presostato alta presión / Pressostat haute pression / Hochdruckwächter / Pressóstato de alta pressão / Högtrycksvakt / Korkean paineen painekytin / Hogedruckschakelaar / Presostat vysokého tlaku / Реле высокого давления / Spínač vysokého tlaku	A1	Scheda elettronica / Control Card / Tarjeta electrónica / Carte électronique / Elektronische Platine / Placa electrónica / Elektroniskt kort / Elektroniikkaohjain / Elektronische kaart / Elektronická deska / Электронная плата / Ovládací karta	FA1	Fusibile scheda elettronica / Control card fuse / Fusibile tarjeta electrónica / Fusible carte électronique / Sicherungen Elektronische Platine / Fusible placa electrónica / Elektroniskt kort säkringar / Elektroniikkaohjain sulakkeet / Zekeringen elektronische kaart / Pojistky elektronická deska / Плавкие предохранители электронная плата / Poistka ovládací karty
⑭	Manometro mandata refrigerante/ Refrigerant discharge manometer/ Manómetro salida refrigerante/ Manomètre refoulement réfrigérant/ Manometer auf Kältemittel Druckseite/ Manómetro de descarga de refrigerante/ Kylvätskeutloppsmanometer/ Manometer afgifte koelmiddel/ Tlakoměr náběhu chladiva/ Манометр системы подачи хладагента/ Manometer vypúšťania chladiva	AI	Ingressi analogici / Analog Inputs / Entradas analógicas / Entrées analogiques / Analogeingänge / Entradas analógicas / Analoga ingångar / Analogiatulot / Analoge ingangen / Analogové vstupy / Вводные устройства аналоговых сигналов / Analógové vstupy	FU1-4 FU11	Fusibili / Fuses / Fusibles / Fusibles / Sicherungen / Fusíveis / Säkringar / Sulakkeet / Zekeringen / Pojistky / Плавкие предохранители / Osigurači / Poistky
⑮	Trasduttore alta pressione/ High pressure transmitter/ Transmisor de alta presión/ Transmetteur haute pression/ Hochdrucktransuktor/ Transmissor de alta pressão/ Högtrycks sändare/ Hoge druktransmitter/ Vysokotlaký Převodník/ Передатчик высокого давления/ Vysielač vysokého tlaku	B0	Sensore temperatura dew point / Dew point temperature sensor / Sensor temperatura punto rocío / Capteur de température dew point / Temperatursensor Taupunkt / Sensores da temperatura dew point / Givare för dagpunkttemperatur / Kastepisteen lämpötilasensori / Temperatuursensor dauwpunt / Čidlo teploty dew point / Датчик температуры точки росы / Teplotný senzor pre dew point	ID	Ingressi digitali / Digital Inputs / Entradas digitais / Entrées numériques / Digitaleingänge / Entradas digitais / Digitala ingångar / Digitaalitulot / Digitale ingangen / Digitální vstupy / Вводные устройства цифровых сигналов / Digitálne vstupy
⑯	Rubinetto scarico condensa / Condensate drain valve / Grifo drenaje condensados / Robinet décharge condensats / Handabsperrventil Kondensatablass / Torneira de descarga da condensação / Kran för kondensavledning / Lauhteenpoistohana / Kraan condensafvoer / Kohoutek odvodu kondenzátu / Kran pliva kondenzáta/ Ventil odtoku kondenzátu	B2-4	Sensore temperatura evaporazione / Evaporation temperature sensor / Sensor temperatura evaporación / Capteur de température évaporation / Temperatursensor Verdampfung / Sensor da temperatura de evaporação / Givare för förångningstemperatur / Lauhdutustämpötilasensori / Temperatuursensor verdamping / ěidlo teploty vyarování / Датчик температуры испарения/ Snímač teploty vyarovania	KM1	Contattore compressore / Compressor contactor / Contactor compresor / Contacteur compresseur / Schützschalter Verdichter / Contactor do compressor / Kompressorin kontaktidon / Kompressorin kontaktori / Urenteller compressor / Stykač kompresoru / Контактор компрессора / Stykač kompresora
⑰	Filtro scarico condensa / Condensate filter valve / Filtro drenaje condensados / Filtre décharge condensats / Filter Kondensatablass / Filtro de descarga da condensação / Filter för kondensavledning / Lauhteenpoistosuodatin / Filter condensafvoer / Filtr odvodu kondenzátu / Фильтр системы слива конденсата / Ventil filtra kondenzátu	B3	Sensore temperatura ambiente / Ambient temperature sensor / Sensor temperatura ambiente / Capteur de température ambiante / Umgebungstemperatursensor / Sensor da temperatura ambiente/ omgivande temperaturgivare / omgivningstemperatuur sensor / snímač okolní teploty / датчик температуры окружающей среды/ snímač okolitej teploty	KM2	Contattore ventilatore / Fan contactor / Contactor ventilador / Contacteur ventilateur / Schützschalter Ventilator / Contactor do ventilador / Fläktens kontaktidon / Puhaltimen kontaktori / Urenteller ventilator / Stykač ventilátoru / Контактор вентилятора / Stykač ventilátora

8.1 LEGEND

Symbol	IT/EN/ES/FR/DE/PT/SV/SU/NL/CS/RU/ SK
PI1	Protezione integrale compressore / Compressor protection / Protección integral compresor / Protection intégrale compresseur / Verdichter-Integralschutz / Protecção integral do compressor / Kompressorns totalskydd / Kompressorin suojaus / Integrale beveiligingsinrichting compressor / Úplný kryt kompresoru / Защита компрессора / Poistka kompresora
QF1	Interruttore automatico / automatic switch / Interruptor automático / Interrup. automatique / FI-Schutzschalter / Interruptor automático / Skyddsströmställare / Automaattinen kytkin / Automatische schakelaar / Automatický vypínač / Автомат. выключатель / Automatický spínač kompresora
QS1	Interruttore generale / Main power switch / Interruptor general / Interrupteur général / Hauptschalter / Interruptor geral / Huvudströmbrytare / Pääkytkin / Hoofdschakelaar / Hlavní vypínač / Главный выключатель / Hlavný vypínač
RC1-2	Filtro antidisturbo / Noise filter / Filtro anti-interferencia / Filtre antiperturbations / Entstörfilter / Filtro anti-interferências / Störskyddsfilter / Häiriönestosuodatin / Antistoringsfilter / Odrusovací filtr / Фильтр подавления помех / Hlukový filter
RO	Off remoto / Remote Off / Apagado remoto / Def remoto / Off Fernsteuerung / Off remoto / Fjärrstyrd avstängning - off / Etäpysäytys / Remote off / Off dálkového ovládání / Устройство дистанционного выключения / Dialkové vypnutie
SL	Linea seriale / Serial line / Línea serie / Liaison série / Serielle Leitung / Linha de série / Serielle linje / Sarjalinja / Serielle lijn / Sériové vedení / Последовательная линия связи / Sériová linka
TC1	Trasformatore ausiliari / Auxiliary transformer / Transformador auxiliares / Transformateur auxiliaires / Transformator Steuervorrichtungen / Transformadores auxiliares / Transformator till hjälpkretsar / Apumuunnin / Hulptransformator / Transformátor pomocná zařízení / Трансформатор вспомогательных цепей / Помощный трансформатор
UD	Uscite digitali / Digital Outputs / Salidas digitales / Sorties numériques / Digitalausgänge / Saídas digitais / Digitala utgångar / Digitaalilähdöt / Digitale uitgangen / Digitální výstupy / Выводные устройства цифровых сигналов / Digitálne výstupy
X1-X5	Morsettiera / Terminal blocks / Borneras / Boîtes à bornes / Klemmenleisten / Réguas de terminais / Morsettiera / Riviliittimet / Klemmenbord / Svorkovnice / Доска зажимов / Svorkovnice

Symbol	IT/EN/ES/FR/DE/PT/SV/SU/NL/CS/RU/ SK
(#)	<p>Componenti presenti nei modelli con scaricatore TEMPORIZZATO. Per altri scaricatori esterni consultare il relativo manuale del costruttore. Components for models with TIMED drain. For other external drains, consult the constructor's manual. Componentes presentes en el modelo con sistema de drenaje TEMPORIZADO. Para los dispositivos de drenaje externos, consulte el manual de fábrica respectivo. Composants présents dans les modèles avec purgeur temporisé. Pour d'autres purgeurs externes, consulter la notice spécifique du constructeur. Komponenten in Modellen mit ZEITGETAKTETER Ablassvorrichtung installiert. Bezüglich anderer externer Ablassvorrichtungen das jeweilige Handbuch des Herstellers einsehen. Componentes existentes nos modelos com descarregador TEMPORIZADO. Para os outros descarregadores externos, consultar o respectivo manual do fabricante. Komponenter på modeller med TIDSSTYRD avledning. För andra externa avledare, se respektive manual utställd av tillverkaren. Aikaohjatulla lauhteenpoistolla varustettujen mallien osat. Muut ulkoiset lauhteenpoistimet, katso valmistajan käyttöohjekirja. Componenten van modellen met afvoerinrichting, die met TIMER zijn uitgerust. Voor andere externe afvoerinrichtingen de betreffende handleiding van de fabrikant raadplegen. Díly, které jsou součástí modelu s ĚASOVANÝM odváděem. V případě jiných vnějších odváděů se oíite pøíslusným návodem výrobce. Компоненты, установленные на моделях с конденсатоотводчиком периодического действия. Информацию о других внешних конденсатоотводчиках смотреть в соответствующем руководстве изготовителя. Komponenty pre modely s NAČASOVANÝM odtokom. Pre iné externé odtoky si pozrite príručku výrobcu.</p>

8.2 INSTALLATION DIAGRAM

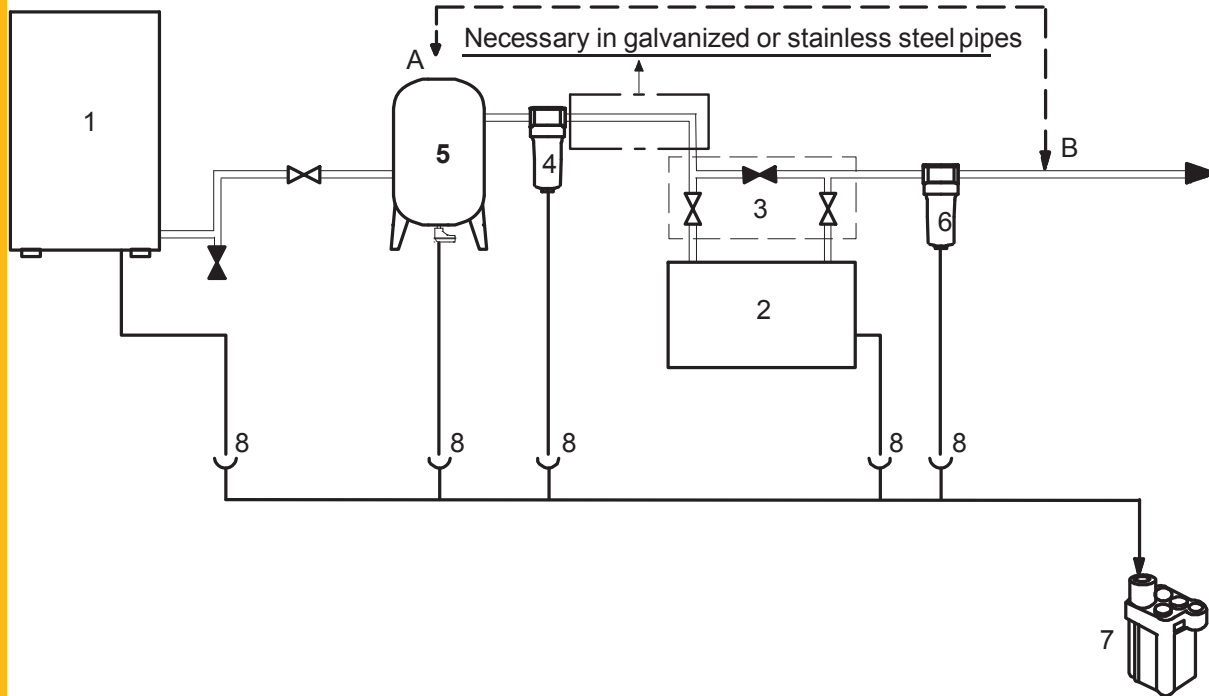





1	2	3
Compressore d'aria Air compressor Compresor de aire Compresseur d'air Luftverdichter Compressor de ar Luftkompressor Ilmakompressor Luchtcompressor Vzduchový kompresor Воздушный компрессор Vzduchový kompresor	Essiccatore Dryer Secador Sécheur Trocknereinheit Secador Torkare Kuivain Droger Susië Osušitel Sušič	Gruppo By-pass By-pass unit Grupo by-pass Groupe by-pass Bypass-Gruppe Grupo de by-pass By-passenhet Ohikiertoryhmä Omloopleiding-groep Jednotka obtoku Об-одно устройство Jednotka obtoku



4	5	6	7	8
Filtro (per filtrazione fino a 3 micron o inferiore) vicino ingresso aria essiccatore Filter (3 micron filtration or better) near dryer air inlet Filtro (filtración de 3 micrones o mejor) cerca de la entrada de aire de la secadora Filtre (filtration des particules de 3 microns minimum) à proximité de l'orifice d'admission d'air du sécheur Filter (mit Filterleistung bis 3 Mikron oder niedriger) nahe am Lufteintritt der Trocknereinheit Filtro (para uma filtragem até 3 micrones ou inferior) perto da entrada de ar do secador Filter (för filtrering ner till 3 micron eller mindre) i närheten av torkarens luftintag Suodatin (suodatusaste korkeintaan 3 mikronia) kuivaimen ilmansyötössä Filter (voor filtering tot 3 micron of lager) dichtbij luchtintag droger Filtr (pro filtraci do 3 mikronů nebo méně) v blízkosti vstupu vzduchu susië Фильтр (для фильтрации частиц размером до 3 микрон или менее) на входе воздуха в осушитель Filter (na filtrovanie až po 3 mikrón a menej)	Serbatoio in posizione A o in B Tank in position A or in B Depósito en la posición A o B Réservoir en position A ou B Behälter in Position A oder B Depósito na posição A ou B Tanken i läge A eller B Säiliö kohdassa A tai B Reservoir in stand A of B Nádržka v poloze A nebo B Ресивер в точке A или B Nádrž v polohe A alebo B	Filtro in uscita Outlet filter Filtro de salida Filtre en sortie Nachfilter am Austritt Filtro na saída Filter vid utlopp Poistosuodatin Filter op uitgan Filtr na wyjoeciu Filtr na výstupu Выходной фильтр Filter na výstupu	Separatore acqua-olio Oil-Water separator Separador agua-aceite Séparateur eau-huile Wasser-Öl-Trenner Separador água-óleo Vatten-oljeseparator Veden/öljyn erotin Olie/water-scheider Odlučovač voda-olej Сепаратор воды-масла Odlučovač voda-olej	Scaricatore di condensa Condensate drain Drenaje de condensados Purgeur des condensats Kondensatablassvorrichtung Descarregador de condensação Kondensavledare Lauhteenpoistin Condensafvoerinrichting Odváděč kondenzátu Сепаратор конденсата Odvádzač kondenzátu

8.2 INSTALLATION DIAGRAM









INSTALLATION DIAGRAM : RECOMMENDED



 	<p>Valvole di sicurezza per non superare pressione di progetto essiccatore. Safety valves for not exceeding dryer design pressure Válvulas de seguridad para no superar la presión de diseño del secador Soupapes de sécurité, pour ne pas dépasser la pression préétablie du sécheur Verwenden Sie Sicherheitsventile um Drucküberschreitungen am Trockner zu vermeiden. Válvulas de segurança para não superar a pressão prevista do secador. Säkerhetsventiler avsedda att säkerställa att torkarens projektryck inte överskrider. Ylipaineventtiilit: estävät kuivaimen mitoituspaineen ylittämisen. Veiligheidskleppen om de toegestane max. druk in de droger niet te overschrijden. Pojistné ventily, které brání překročení tlaku systému vysusovače. Предохранительный клапан, исключающий достижение в осушителе давления выше расчетного. Bezpečnostné ventily brániace prekročeniu projektového tlaku sušiča.</p>
--	---

 	<p>Tubi flessibili per connessioni aria se la rete è soggetta a vibrazioni Hoses for air connections if the system undergoes vibrations Tubos flexibles para las conexiones de aire si la red está expuesta a vibraciones Tuyaux flexibles pour raccordements de l'air si le réseau est soumis à des vibrations Schläuche für Luftanschlüsse, falls das Netz Vibrationen ausgesetzt ist. Tubos flexíveis para ligações de ar, caso a instalação esteja sujeita a vibrações. Flexibla rör för luftanslutningar om nätet utsätts för vibrationer Letkut ilmaliitäntöjä varten, jos putkisto altistuu värähtelyille Flexibele leidingen voor luchtaansluitingen als het leidingennet aan trillingen blootstaat. Hadice pro připojení vzduchu, je-li sít' vystavená vibracím Гибкие шланги для выполнения соединений в пневматических системах, подвергающихся ибрации Hadice na prepojenie vzduchu, ak je siet' vystavená vibráciám</p>
--	--

 	<p>Opportuni smorzatori se la rete è soggetta a pulsazioni Suitable dampers if the system undergoes pulsations Amortiguadores si la red está expuesta a pulsaciones Amortisseurs hydrauliques appropriés si le réseau est soumis à des pulsations Geeignete Dämpfer, falls das Netz Schlagbeanspruchungen ausgesetzt ist. Amortecedores adequados caso a instalação esteja sujeita a pulsações. Dämpare av lämplig typ, om nätet utsätts för svängningar. Sopivat värähtelynestolaitteet, jos putkisto altistuu virtausvärähtelyille. Geschikte dempers indien het leidingennet aan schokken is blootgesteld. Hadice pro připojení vzduchu, je-li sít' vystavená vibracím Гибкие шланги для выполнения соединений в пневматических системах, подвергающихся ибрации Hadice na prepojenie vzduchu, ak je siet' vystavená vibráciám</p>
--	---

8.3 TECHNICAL DATA

Model	Weight 	Refrigerant R513A				N° of coolers	MIN.- MAX Ambient Temperature		Compressed air inlet Temp. 	F.L.A.[A] 400V±10% /3Ph/50Hz 460V±10% /3Ph/60Hz	MOP	MCA	Connections			Sound pressure level 	
							Amb 						Compres. air IN/OUT 	Water condens. IN/OUT 	Conden. drain 		
		During transp. & stockag. 	After install. 														
		Ac	Wc		N°		°C	°C					°C	A	A		A
PSE 460	380	2.7	1,70	3.8	2.39	1	0-50	5-50	5-65	14.2	30	17.5	UNI PN16 - DN100	3/4"	1/2"	58	
PSE 520	380	2.8	1,78	2.9	1.82	1				17.4	35	21.5					
PSE 630	420	2.0	1,26	3.2	2,01	1				20.5	40	25.5					
PSE 750	730	7.6	4,78	7.0	4.40	2				31.6	65	39	UNI PN16 - DN150	1.1/4"	69		
PSE 900	770	7.5	4,72	8.5	5,35	2				37.8	80	47					
PSE 1200	850	6.0	3,77	6.0	3.77	2				37.8	80	47					
PSE 1500	1070	15.0	9,44	12.3	7.74	3				52.3	110	65	UNI PN16 - DN200				
PSE 1800	1210	13.0	8,15	11.0	6.92	3				59.4	125	74					

Calibration values 	Hot gas valve HGV	Pressure condensation		High pressure Switch HP	Low pressure Switch LP	Operating Pressure Max 	Water pressostatic valve WPV	IP	Safety valve
		Pressure	Fan speed						
PSE 460-1500	2.5 bar	10 bar	0 %	20 bar	1.0-2.0 bar	14 bar	10-11 bar	54	-
PSE 1800		13 bar	100 %						22 bar

8.4 SPARE PARTS

COMPONENTS		See par. 8.5	PSE 460	PSE 520	PSE 630	PSE 750	PSE 900	PSE 1200	PSE 1500	PSE 1800	
3 years preventive maintenance kits	Ac/ Wc	⑧ ⑩ ⑬ ⑮ B0 B2 B8	398H473757								
Electrical Kit	Ac/Wc		398H473759								
Compressor kit	Ac/Wc	① ④ KM1	398H473766	398H473767	398H473768	398H473769	398H473770		398H473771	398H473772	
Fan kit	Ac	③	398H473774			398H473775			398H473776		
Hot gas valve kit	Ac/Wc	④ ⑫	398H473779		398H473780	398H473781			398H473782		
Refrigerant condenser	Ac	②	ET-398H114845			ET-398H114846			ET-398H114847		
Shell & tube exchanger	Wc	②.2	ET-398H186234	ET-398H186235		ET-398H186236	ET-398H186237			ET-398H186193	
Water pressostatic valve	Wc	③.	398H378209			398H378204			ET-398H378220		
Refrigerant filter	Ac/Wc	④	398H206254		ET-398H206257						
Liquid line solenoid valve	Ac/Wc	⑤	ET-398H183148								
Water - air exchanger / Separator / Air-air exchanger	Ac/Wc	⑦	398H473479		398H473480	398H473479		398H473480	398H473479	398H473480	
Low Pressure transmitter	Ac	⑧	ET-398H275315								
Pressure gauge	Ac	⑩ ⑭	ET-398H354042								
Low pressure switch	Ac/Wc	⑪	ET-398H474521								
High pressure switch	Ac	⑬	ET-398H474520						ET-398H474523		
High Pressure transmitter	Ac	⑮	ET-398H275311								
Water pressostatic valve	Wc S&T	⑳	398H378202			398H378203	398H378204	398H378204	398H378204	ET-398H378220	
Safety Valve kit	Ac/Wc	⑳	-						398H473783		

8.4 SPARE PARTS

COMPONENTS		See par. 8.5	PSE 460	PSE 520	PSE 630	PSE 750	PSE 900	PSE 1200	PSE 1500	PSE 1800	
Electronic card touch AVC6200	Ac/Wc	A1	398H473785								
Expansion EVE6000	Ac/Wc	-	398H473786								
Display touch	Ac	-	398H473788								
	Wc	-	398H473788Y001								
Hot gas valve control	Ac/Wc	-	398H473789								
Dew point/ evaporator temperature sensor (3m)	Ac/Wc	B0	398H275894								
Evaporation temperature sensor	Ac/Wc	B2-4	398H275894								
Ambient temperature sensor	Ac/Wc	B3	398H275894								
Suction temperature sensor	Ac/Wc	B5	398H275894								
Discharge temperature sensor	Ac/Wc	B8	ET-398H275973								
Condensate level sensor	Ac/Wc	CS3/4/5	398H275752								
Phases monitor	Ac/Wc	A4	398H256366				-				
Crankcase heater	Ac/Wc	EH1	ET-398H328262			ET-398H328264					
Main disconnect switch	Ac/Wc	QS1	398H256406			398H256422			398H256424		
Compressor Automatic switch	Ac/Wc	QF1	ET-398H256297			ET-398H256302	ET-398H256201		ET-398H256200		
Compressor contactor	Ac/Wc	KM1	398H256246			398H256325	398H256296		ET-398H256251		
Fan contactor	Ac	KM2	398H256243								
Auxiliary transformer	Ac/Wc	TC1	ET-398H255857								
Condensate drain solenoid valve	Ac/Wc	19-20-21	398H698218								

8.5 EXPLODED DRAWING PSE460-630 Ac

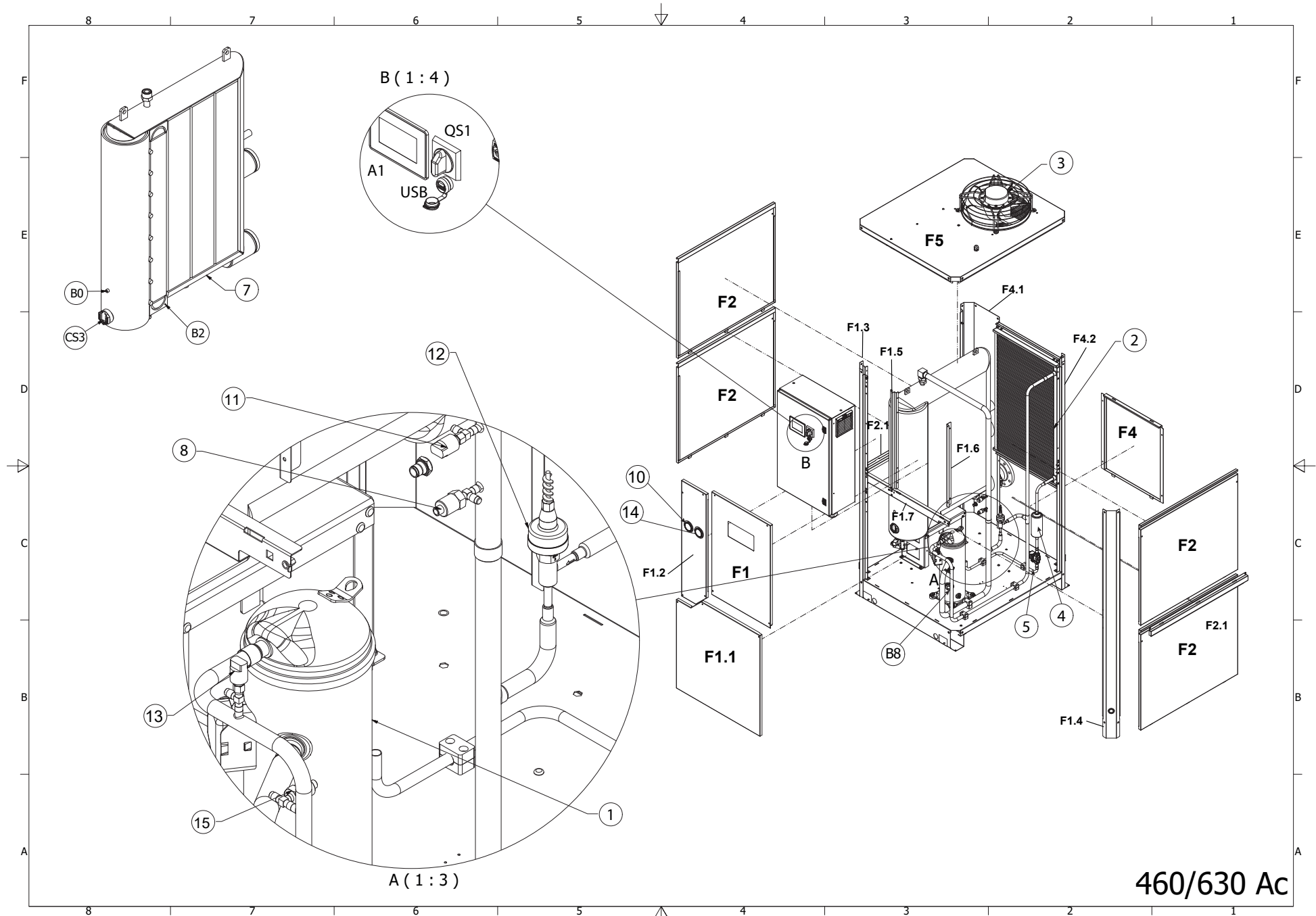

460/630 Ac

8.5 EXPLODED DRAWING PSE750-1200 Ac

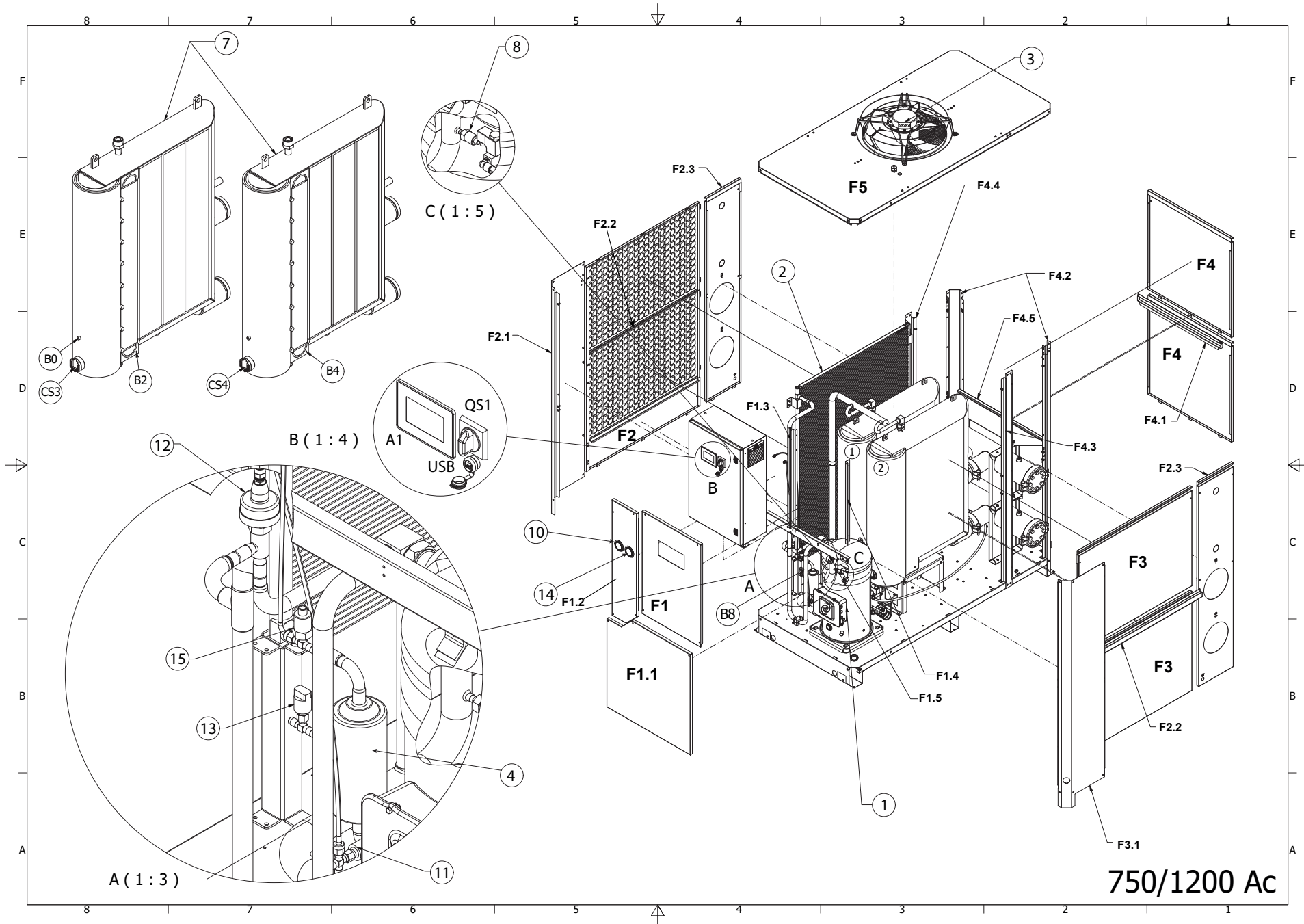

750/1200 Ac

8.5 EXPLODED DRAWING PSE1500-1800 Ac

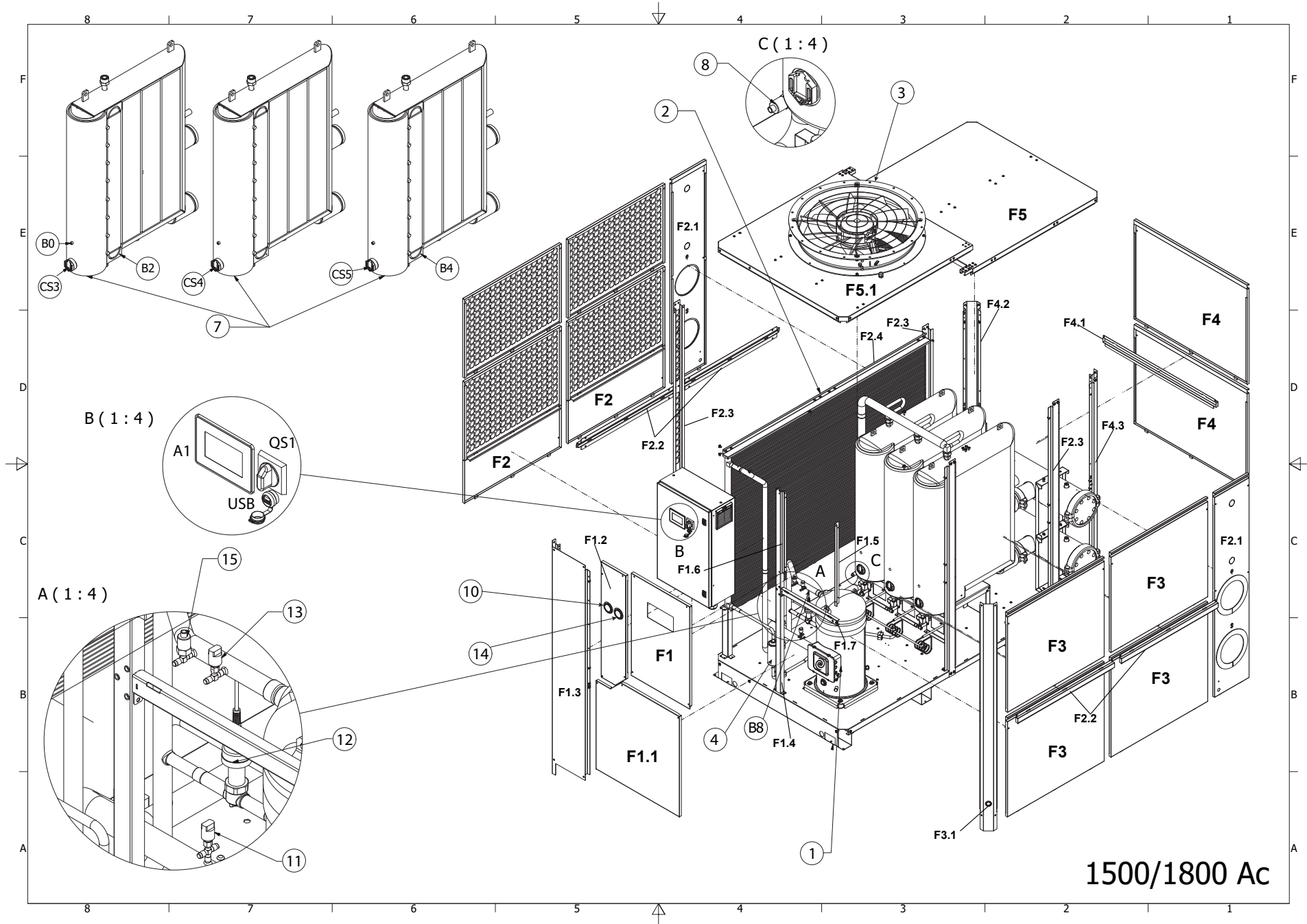

1500/1800 Ac

8.5 EXPLODED DRAWING PSE460-630 Wc

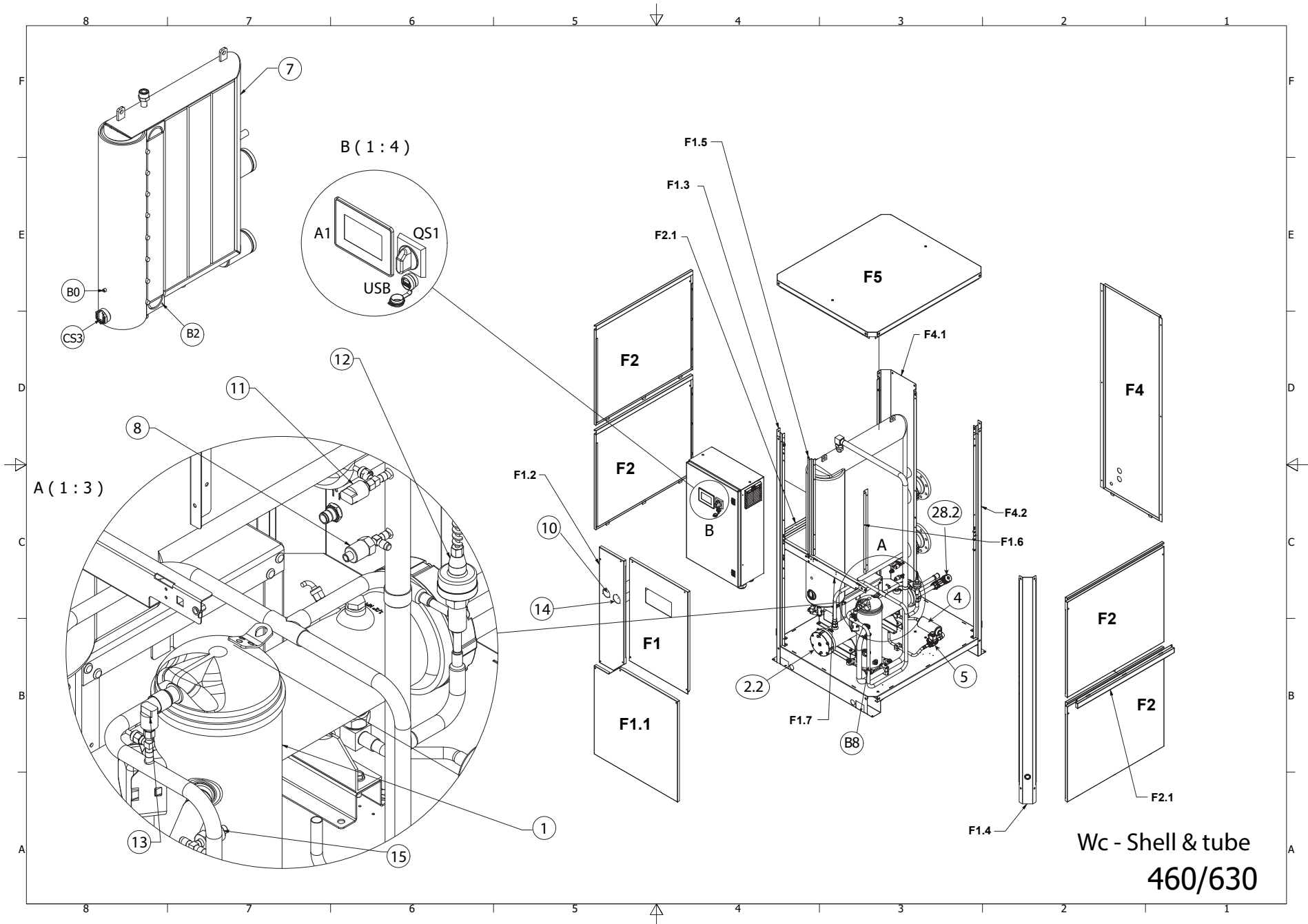

Wc - Shell & tube
460/630

8.5 EXPLODED DRAWING PSE750-1200 Wc

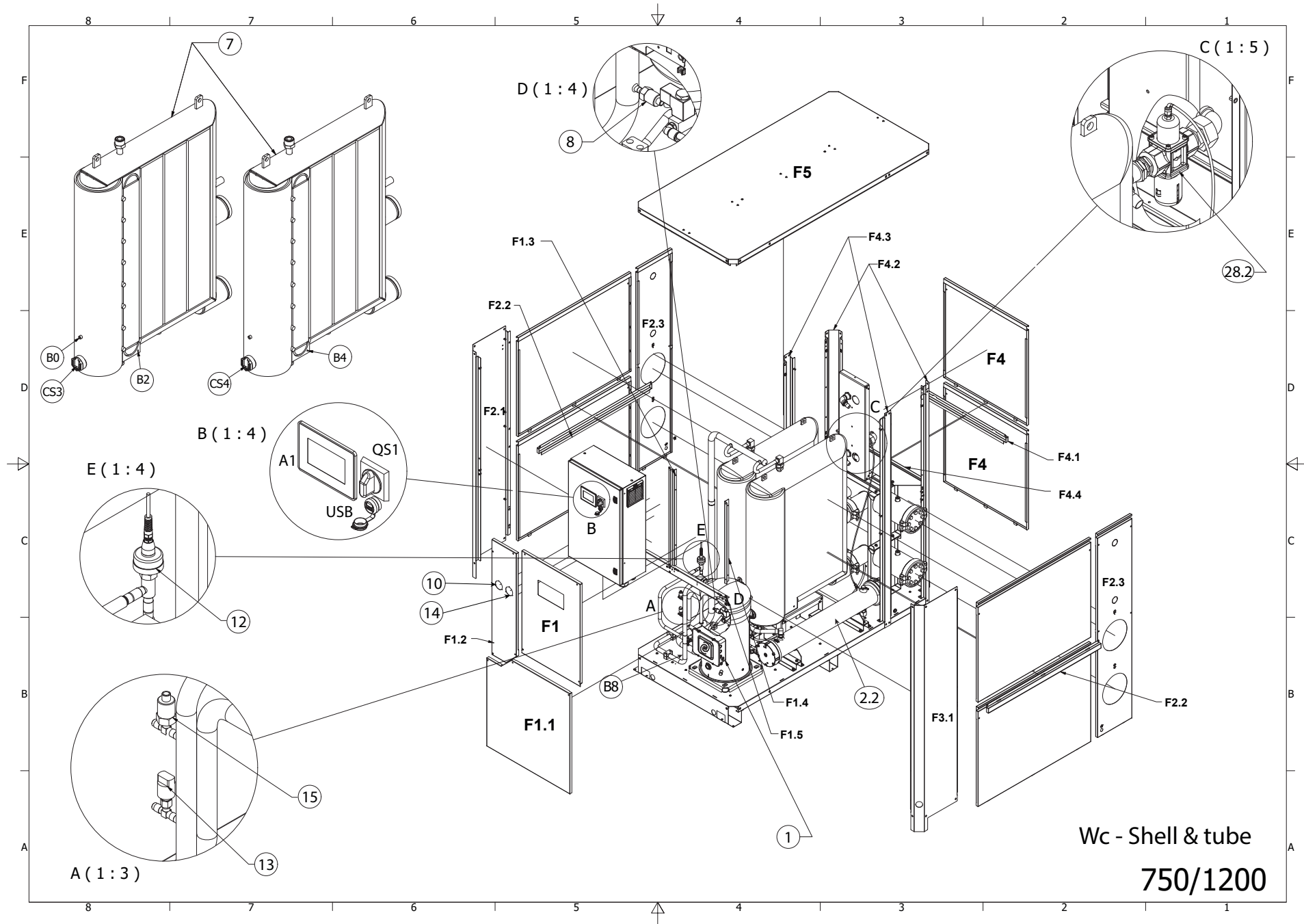

Wc - Shell & tube
750/1200

8.5 EXPLODED DRAWING PSE1500-1800 Wc

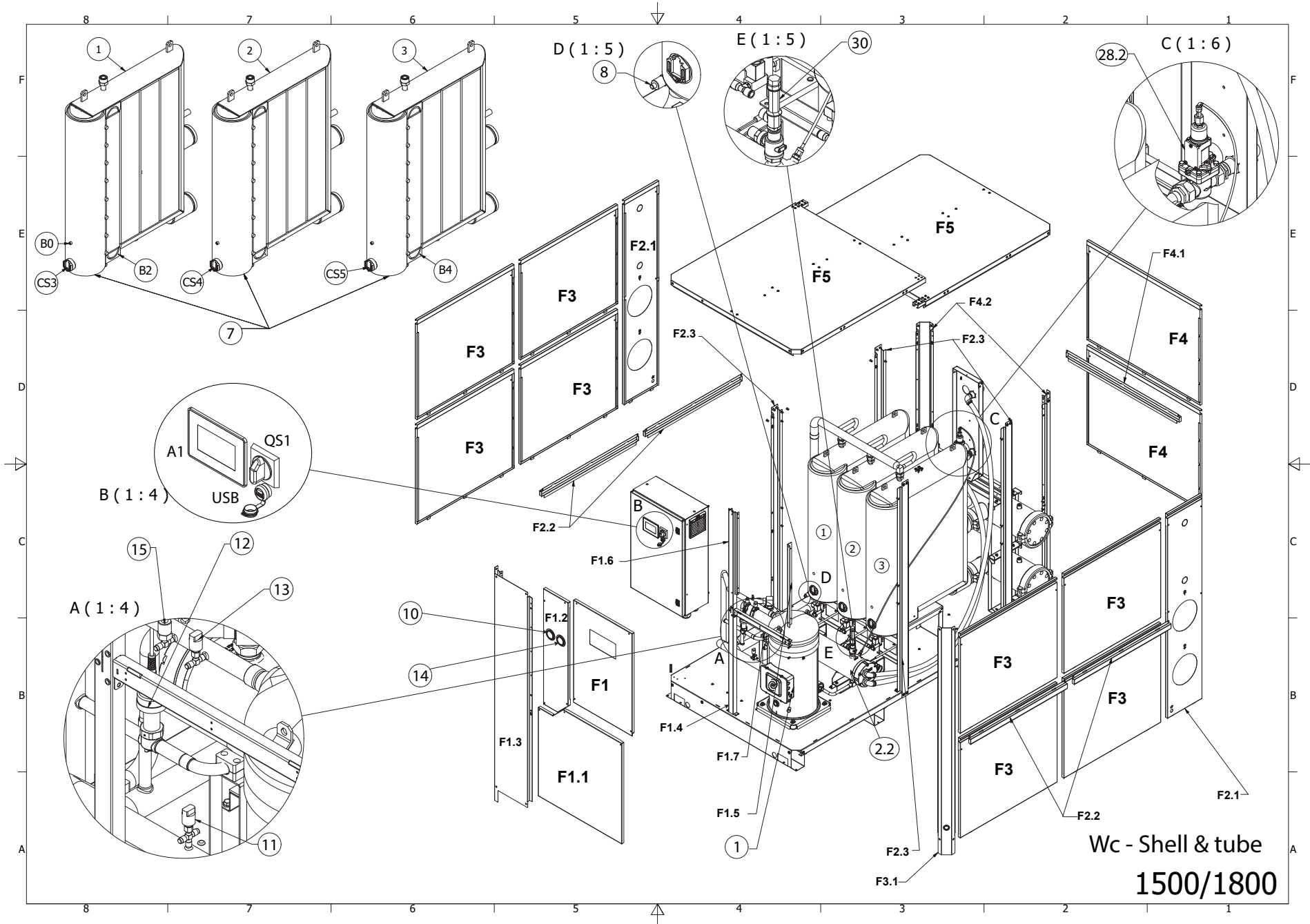

Wc - Shell & tube
1500/1800

8.6 DIMENSIONAL DRAWING PSE 460-630 Ac

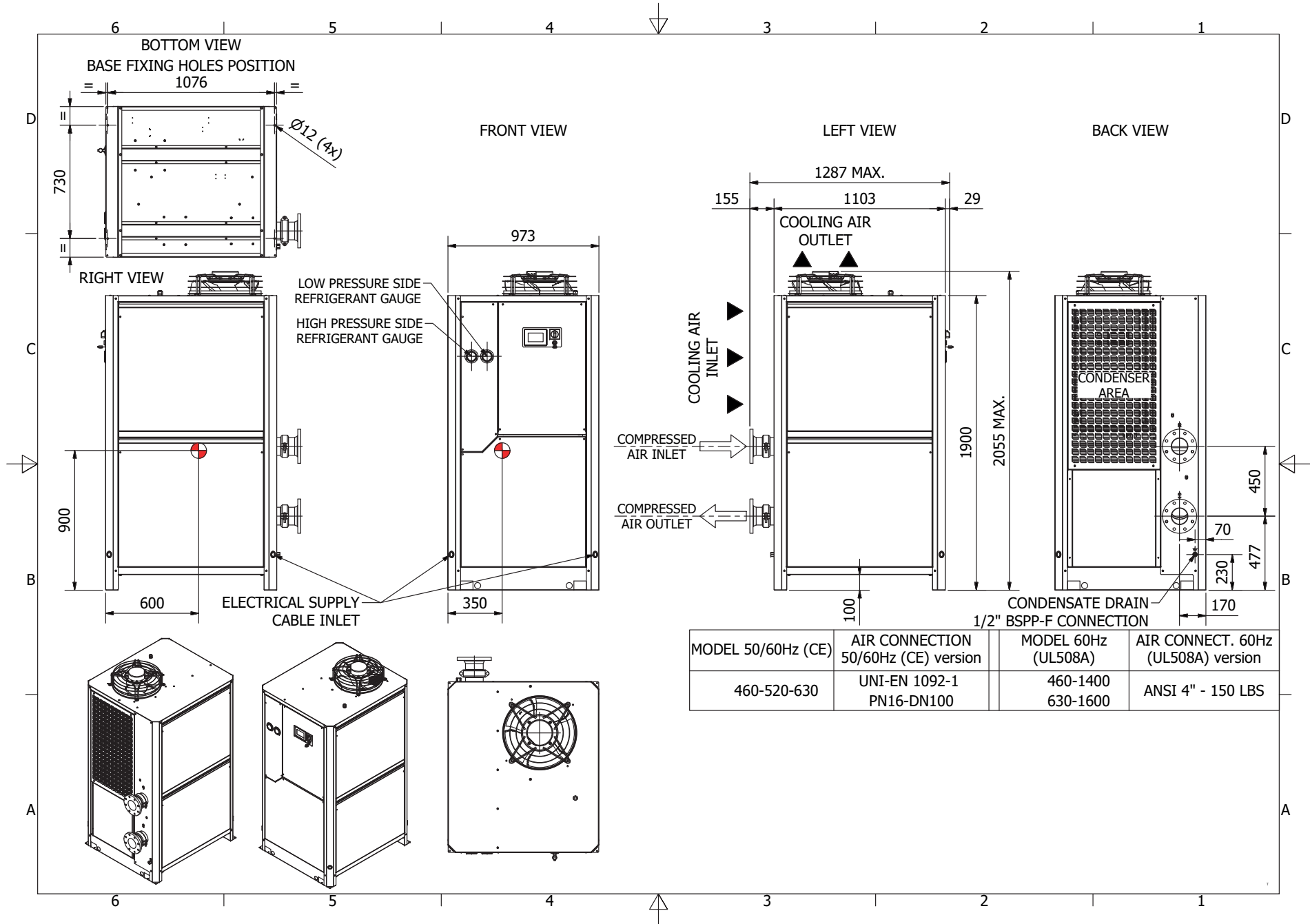

MODEL 50/60Hz (CE)	AIR CONNECTION 50/60Hz (CE) version	MODEL 60Hz (UL508A)	AIR CONNECT. 60Hz (UL508A) version
460-520-630	UNI-EN 1092-1 PN16-DN100	460-1400 630-1600	ANSI 4" - 150 LBS

8.6 DIMENSIONAL DRAWING PSE 750-1200 Ac

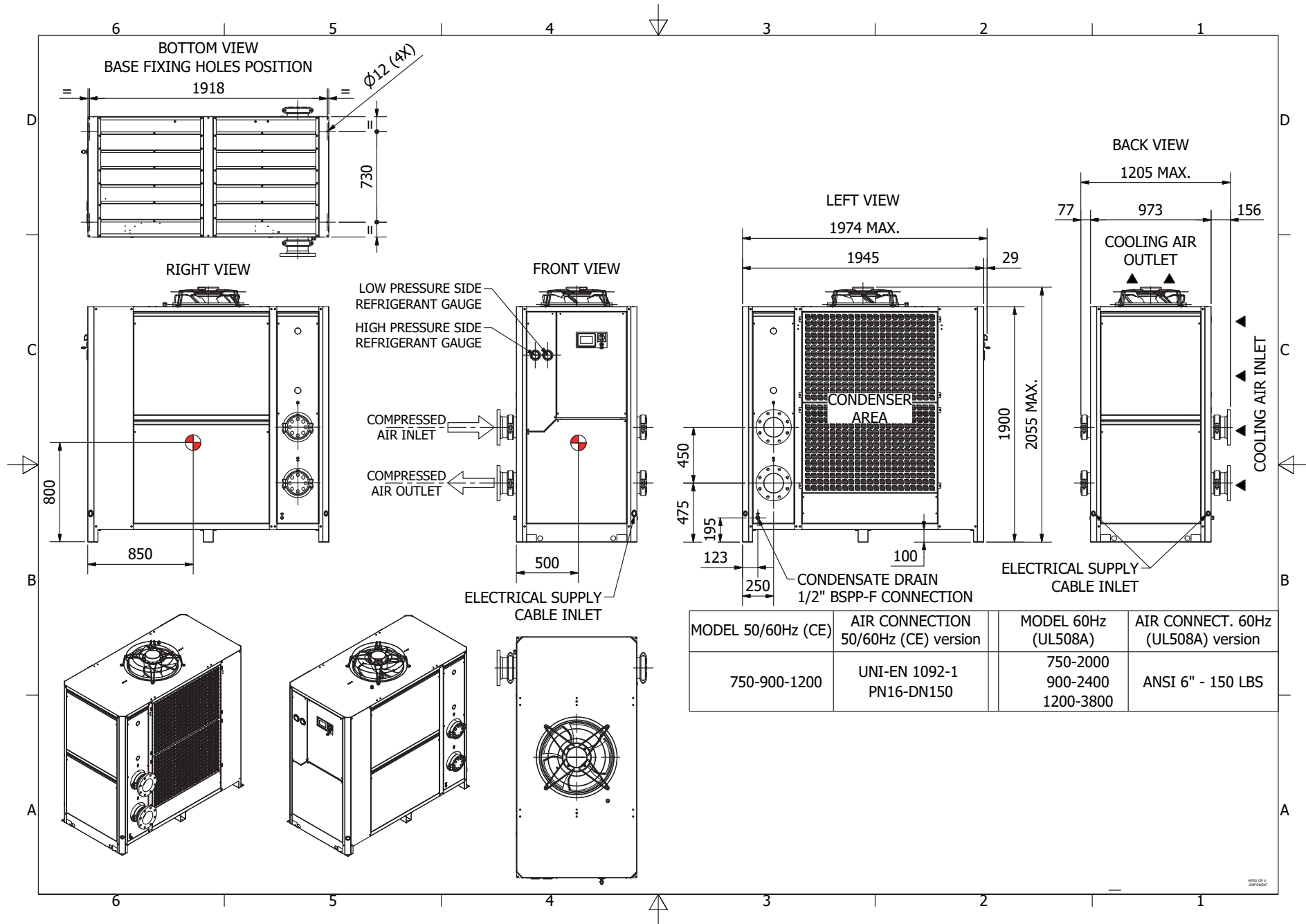

MODEL 50/60Hz (CE)	AIR CONNECTION 50/60Hz (CE) version	MODEL 60Hz (UL508A)	AIR CONNECT. 60Hz (UL508A) version
750-900-1200	UNI-EN 1092-1 PN16-DN150	750-2000 900-2400 1200-3800	ANSI 6" - 150 LBS

8.6 DIMENSIONAL DRAWING PSE 1500-1800 Ac

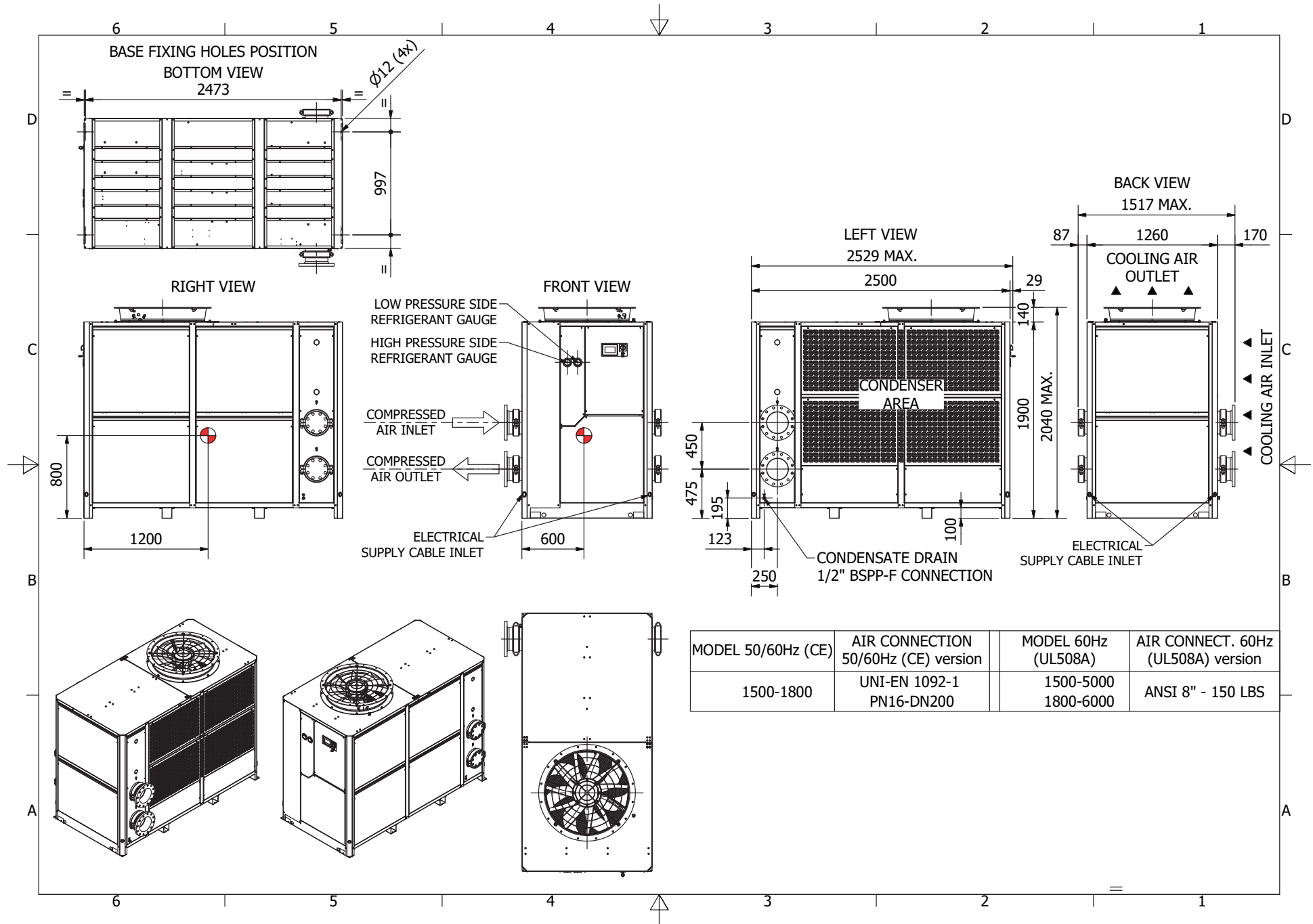

8.6 DIMENSIONAL DRAWING PSE 460-630 Wc

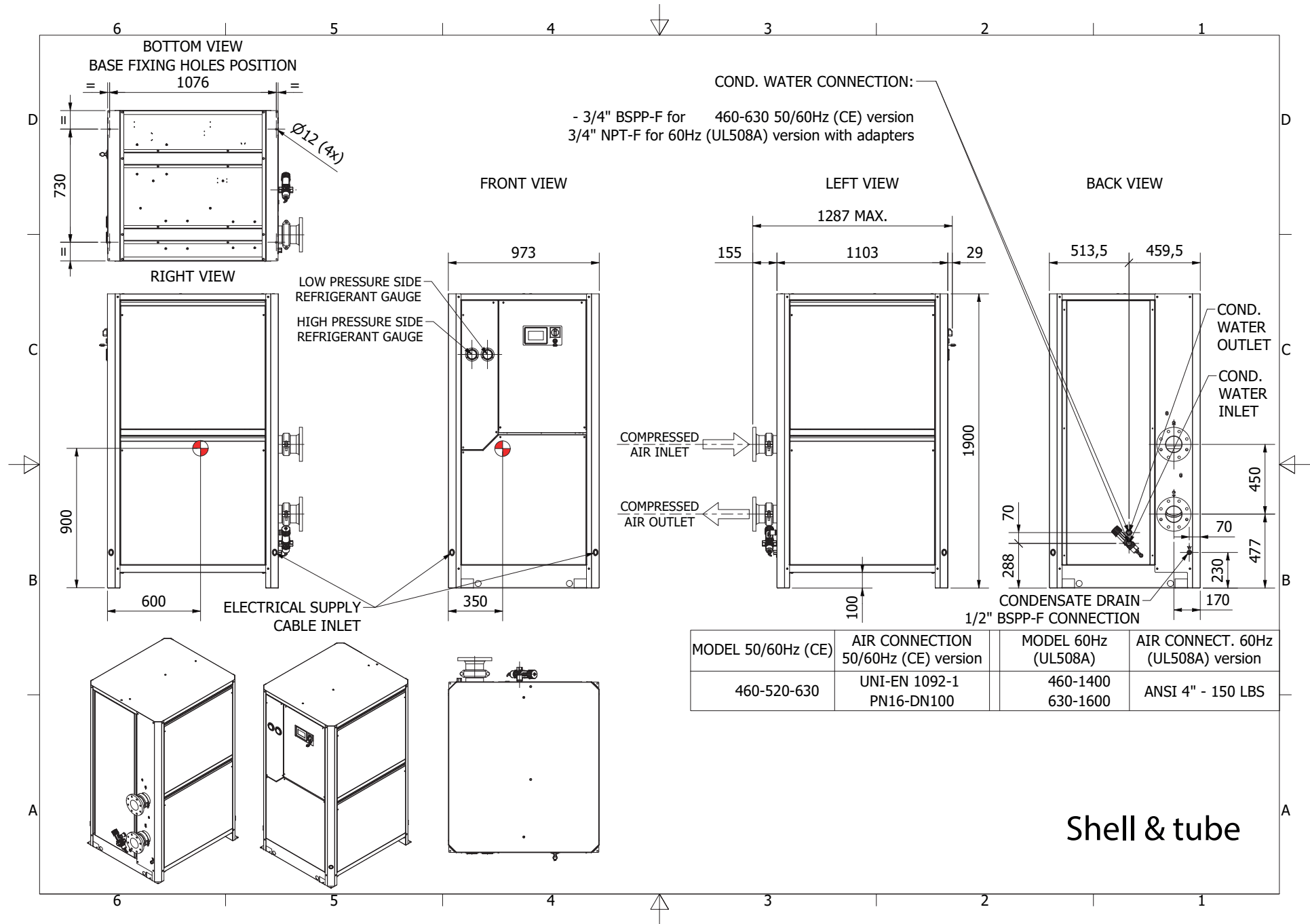

MODEL 50/60Hz (CE)	AIR CONNECTION 50/60Hz (CE) version	MODEL 60Hz (UL508A)	AIR CONNECT. 60Hz (UL508A) version
460-520-630	UNI-EN 1092-1 PN16-DN100	460-1400 630-1600	ANSI 4" - 150 LBS

8.6 DIMENSIONAL DRAWING PSE 750-1200 Wc

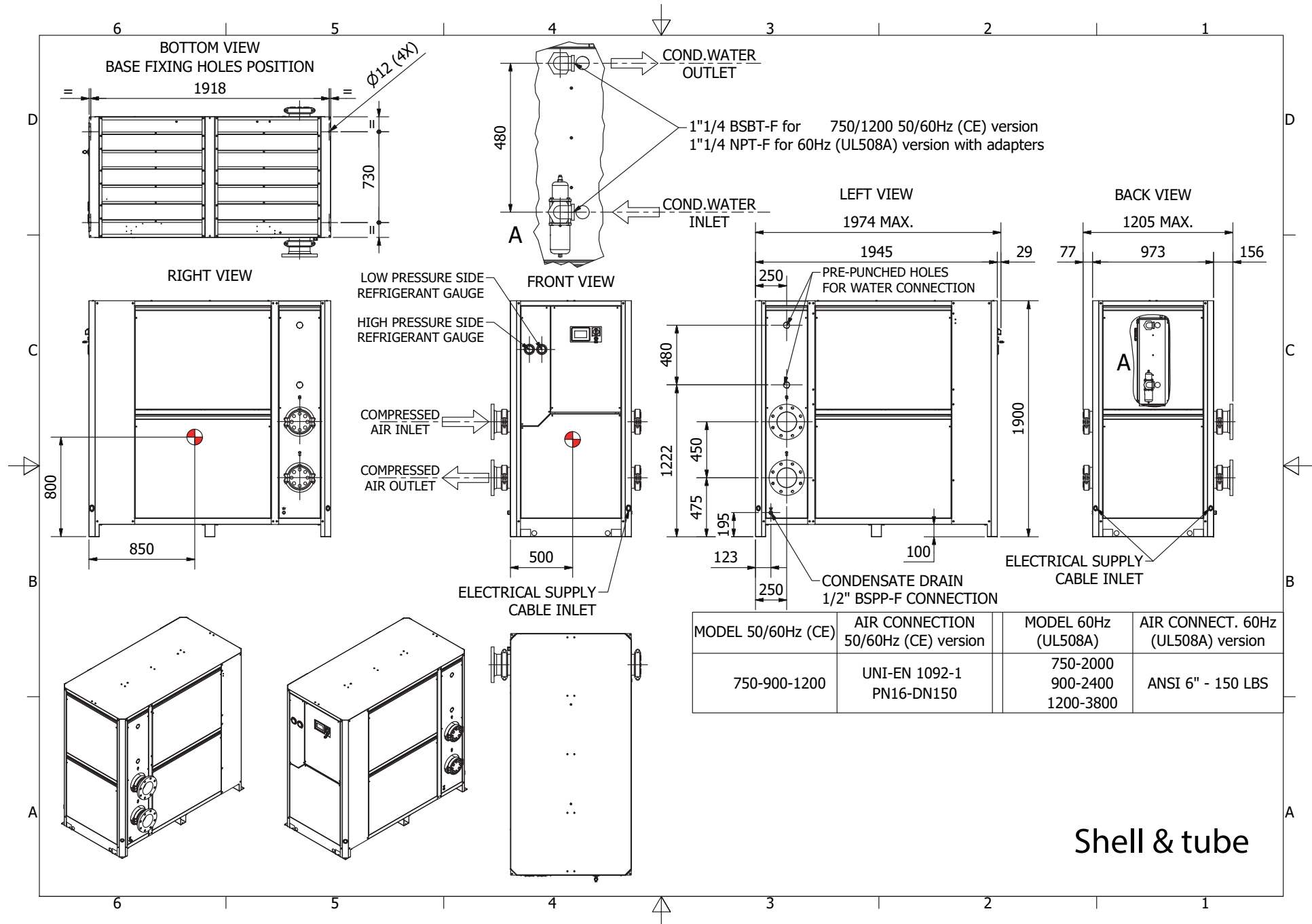

8.6 DIMENSIONAL DRAWING PSE 1500-1800 Wc

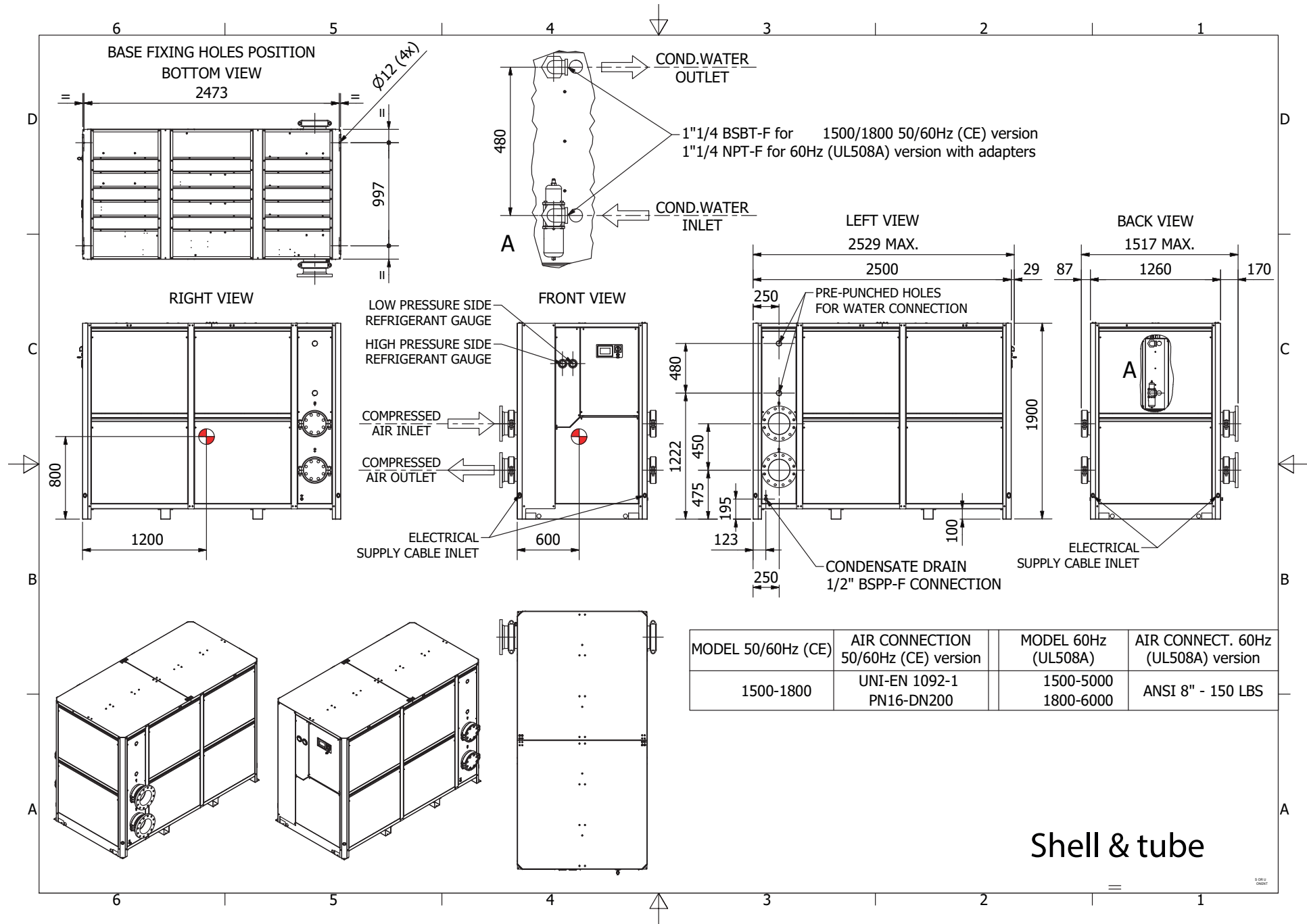

MODEL 50/60Hz (CE)	AIR CONNECTION 50/60Hz (CE) version	MODEL 60Hz (UL508A)	AIR CONNECT. 60Hz (UL508A) version
1500-1800	UNI-EN 1092-1 PN16-DN200	1500-5000 1800-6000	ANSI 8" - 150 LBS

8.7 REFRIGERANT CIRCUIT PSE 460-630 Ac

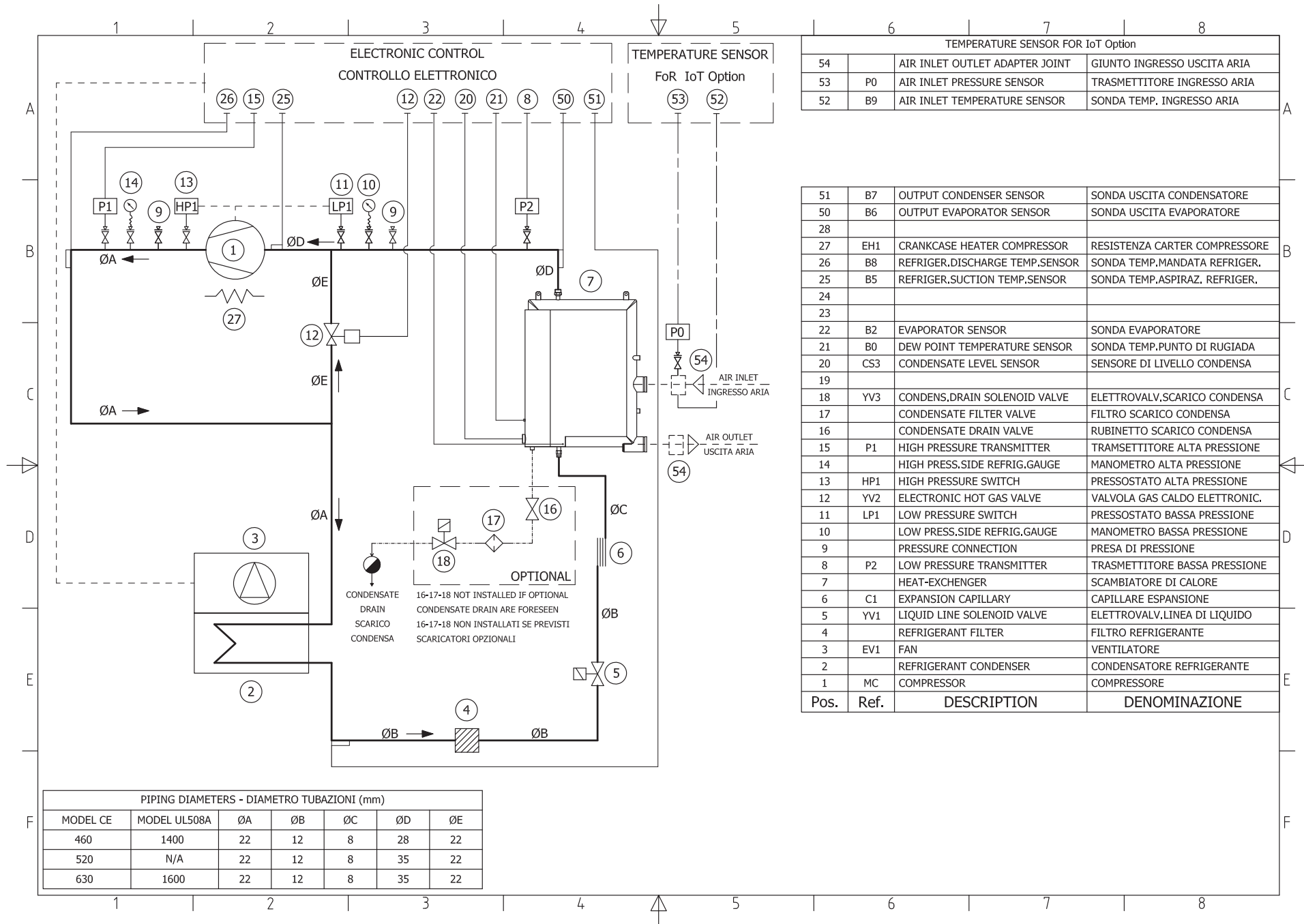

8.7 REFRIGERANT CIRCUIT PSE 750-1200 Ac

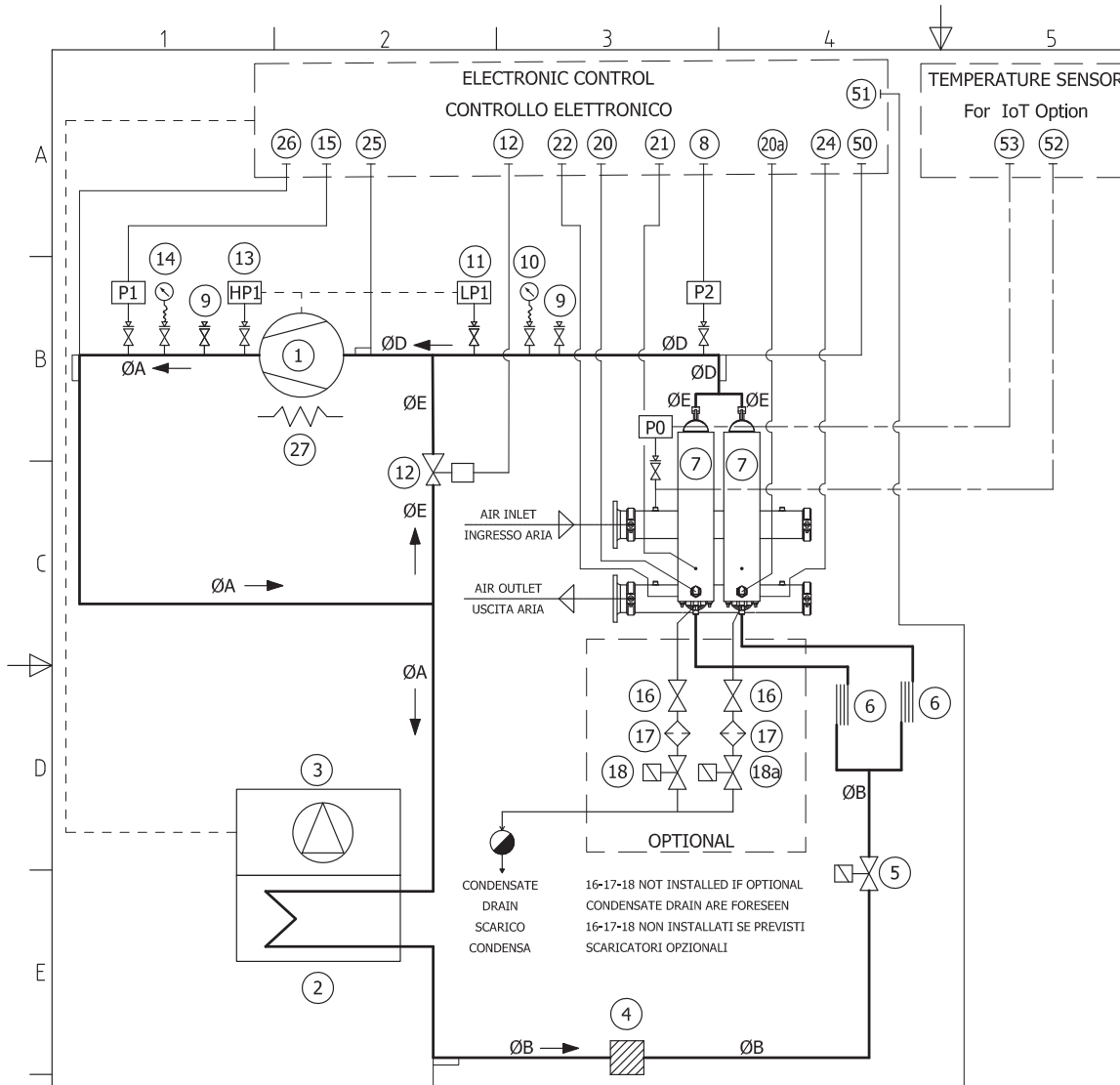

TEMPERATURE SENSOR FOR IoT OPTION			
53	P0	AIR INLET PRESSURE SENSOR	TRASMETTITORE INGRESSO ARIA
52	B9	AIR INLET TEMPERATURE SENSOR	SONDA TEMP. INGRESSO ARIA

51	B7	OUTPUT CONDENSER SENSOR	SONDA USCITA CONDENSATORE
50	B6	OUTPUT EVAPORATOR SENSOR	SONDA USCITA EVAPORATORE
28			
27	EH1	CRANKCASE HEATER COMPRESSOR	RESISTENZA CARTER COMPRESSORE
26	B8	REFRIGER. DISCHARGE TEMP. SENSOR	SONDA TEMP. MANDATA REFRIGER.
25	B5	REFRIGER. SUCTION TEMP. SENSOR	SONDA TEMP. ASPIRAZ. REFRIGER.
24	B4	EVAPORATOR SENSOR (Multicooler)	SONDA EVAPORATORE (Secondo evap)
23			
22	B2	EVAPORATOR SENSOR	SONDA EVAPORATORE
21	B0	DEW POINT TEMPERATURE SENSOR	SONDA TEMP. PUNTO DI RUGIADA
20a	CS4	CONDENSATE LEVEL SENSOR	SENSORE DI LIVELLO CONDENSA
20	CS3	CONDENSATE LEVEL SENSOR	SENSORE DI LIVELLO CONDENSA
19			
18a	YV4	CONDENS. DRAIN SOLENOID VALVE	ELETTROVALV. SCARICO CONDENSA
18	YV3	CONDENS. DRAIN SOLENOID VALVE	ELETTROVALV. SCARICO CONDENSA
17		CONDENSATE FILTER VALVE	FILTRO SCARICO CONDENSA
16		CONDENSATE DRAIN VALVE	RUBINETTO SCARICO CONDENSA
15	P1	HIGH PRESSURE TRANSMITTER	TRASMETTITORE ALTA PRESSIONE
14		HIGH PRESS. SIDE REFRIG. GAUGE	MANOMETRO ALTA PRESSIONE
13	HP1	HIGH PRESSURE SWITCH	PRESSOSTATO ALTA PRESSIONE
12	YV2	ELECTRONIC HOT GAS VALVE	VALVOLA GAS CALDO ELETTRONIC.
11	LP1	LOW PRESSURE SWITCH	PRESSOSTATO BASSA PRESSIONE
10		LOW PRESS. SIDE REFRIG. GAUGE	MANOMETRO BASSA PRESSIONE
9		PRESSURE CONNECTION	PRESA DI PRESSIONE
8	P2	LOW PRESSURE TRANSMITTER	TRASMETTITORE BASSA PRESSIONE
7		HEAT-EXCHANGER	SCAMBIATORE DI CALORE
6	C1	EXPANSION CAPILLARY	CAPILLARE ESPANSIONE
5	YV1	LIQUID LINE SOLENOID VALVE	ELETTROVALV. LINEA DI LIQUIDO
4		REFRIGERANT FILTER	FILTRO REFRIGERANTE
3	EV1	FAN	VENTILATORE
2		REFRIGERANT CONDENSER	CONDENSATORE REFRIGERANTE
1	MC	COMPRESSOR	COMPRESSORE
Pos.	Ref.	DESCRIPTION	DENOMINAZIONE

PIPING DIAMETERS - DIAMETRO TUBAZIONI (mm)						
MODEL CE	MODEL UL508a	ØA	ØB	ØC	ØD	ØE
750	2000	22	12	8	28	22
900	2400	22	12	8	35	22
1200	3000-3800	22	12	8	35	22

8.7 REFRIGERANT CIRCUIT PSE 1500-1800 Ac

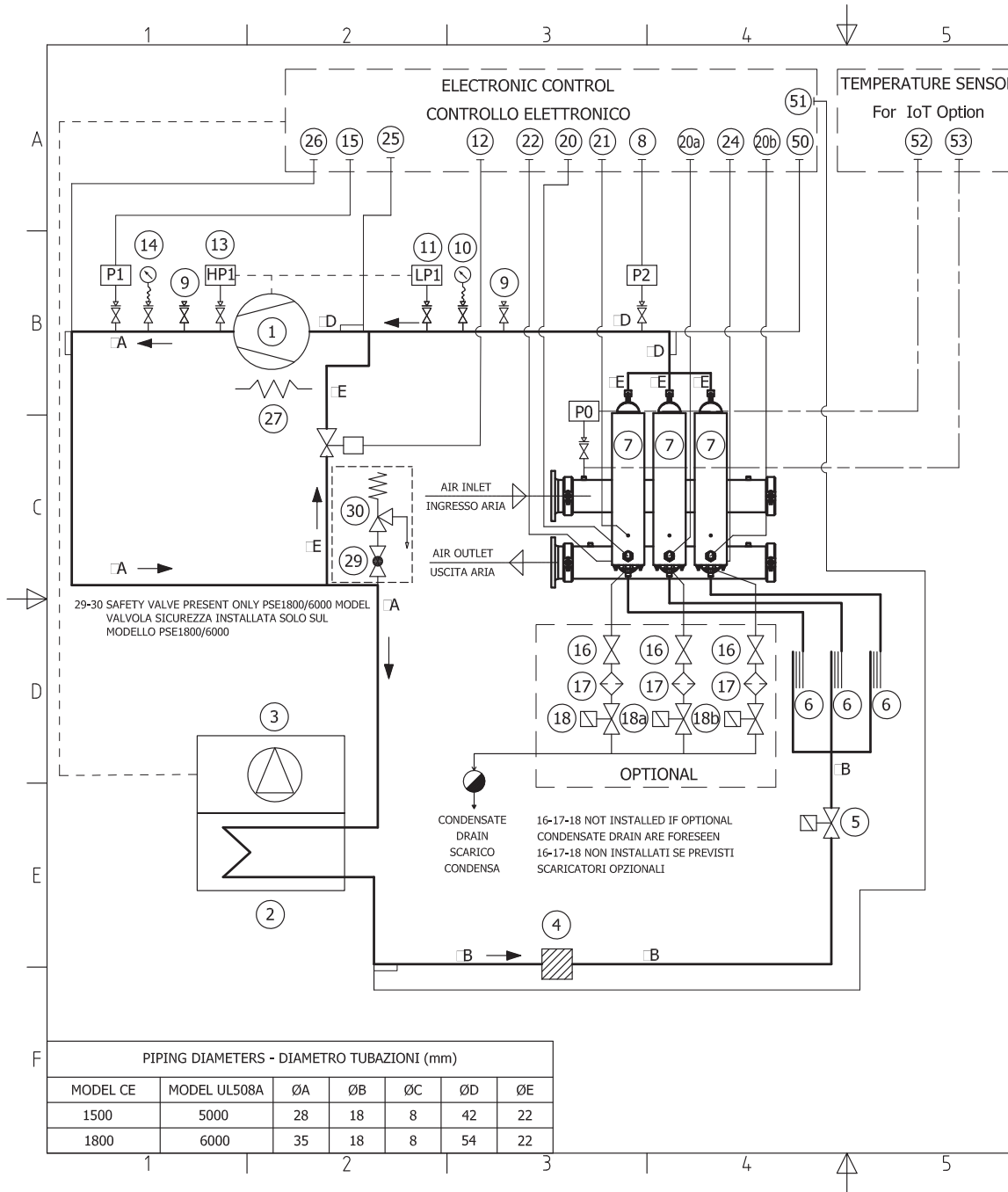

TEMPERATURE SENSOR FOR IoT OPTION			
53	P0	AIR INLET PRESSURE SENSOR	TRASMETTITORE INGRESSO ARIA
52	B9	AIR INLET TEMPERATURE SENSOR	SONDA TEMP. INGRESSO ARIA
51	B7	OUTPUT CONDENSER SENSOR	SONDA USCITA CONDENSATORE
50	B6	OUTPUT EVAPORATOR SENSOR	SONDA USCITA EVAPORATORE
30		DISCHARGE SAFETY VALVE	VALVOLA DI SICUREZZA MANDATA
29		VALVE	RUBINETTO
28			
27	EH1	CRANKCASE HEATER COMP. (Option)	RESISTENZA CARTER COMP.(Opzione)
26	B8	REFRIGER.DISCHARGE TEMP.SENSOR	SONDA TEMP.MANDATA REFRIGER.
25	B5	REFRIGER.SUCTION TEMP.SENSOR	SONDA TEMP.ASPIRAZ. REFRIGER.
24	B4	EVAPORATOR SENSOR(Multicooler)	SONDA EVAPORATORE(Secondo evap)
23			
22	B2	EVAPORATOR SENSOR	SONDA EVAPORATORE
21	B0	DEW POINT TEMPERATURE SENSOR	SONDA TEMP.PUNTO DI RUGIADA
20b	CS5	CONDENSATE LEVEL SENSOR	SENSORE DI LIVELLO CONDENSA
20a	CS4	CONDENSATE LEVEL SENSOR	SENSORE DI LIVELLO CONDENSA
20	CS3	CONDENSATE LEVEL SENSOR	SENSORE DI LIVELLO CONDENSA
19			
18b	YV5	CONDENS.DRAIN SOLENOID VALVE	ELETTROVALV.SCARICO CONDENSA
18a	YV4	CONDENS.DRAIN SOLENOID VALVE	ELETTROVALV.SCARICO CONDENSA
18	YV3	CONDENS.DRAIN SOLENOID VALVE	ELETTROVALV.SCARICO CONDENSA
17		CONDENSATE FILTER VALVE	FILTRO SCARICO CONDENSA
16		CONDENSATE DRAIN VALVE	RUBINETTO SCARICO CONDENSA
15	P1	HIGH PRESSURE TRANSMITTER	TRASMETTITORE ALTA PRESSIONE
14		HIGH PRESS.SIDE REFRIG.GAUGE	MANOMETRO ALTA PRESSIONE
13	HP1	HIGH PRESSURE SWITCH	PRESSOSTATO ALTA PRESSIONE
12	YV2	ELECTRONIC HOT GAS VALVE	VALVOLA GAS CALDO ELETTRONIC.
11	LP1	LOW PRESSURE SWITCH	PRESSOSTATO BASSA PRESSIONE
10		LOW PRESS.SIDE REFRIG.GAUGE	MANOMETRO BASSA PRESSIONE
9		PRESSURE CONNECTION	PRESA DI PRESSIONE
8	P2	LOW PRESSURE TRANSMITTER	TRASMETTITORE BASSA PRESSIONE
7		HEAT-EXCHANGER	SCAMBIATORE DI CALORE
6	C1	EXPANSION CAPILLARY	CAPILLARE ESPANSIONE
5	YV1	LIQUID LINE SOLENOID VALVE	ELETTROVALV.LINEA DI LIQUIDO
4		REFRIGERANT FILTER	FILTRO REFRIGERANTE
3	EV1	FAN	VENTILATORE
2		REFRIGERANT CONDENSER	CONDENSATORE REFRIGERANTE
1	MC	COMPRESSOR	COMPRESSORE
Pos.	Ref.	DESCRIPTION	DENOMINAZIONE

8.7 REFRIGERANT CIRCUIT PSE 460-630 Wc

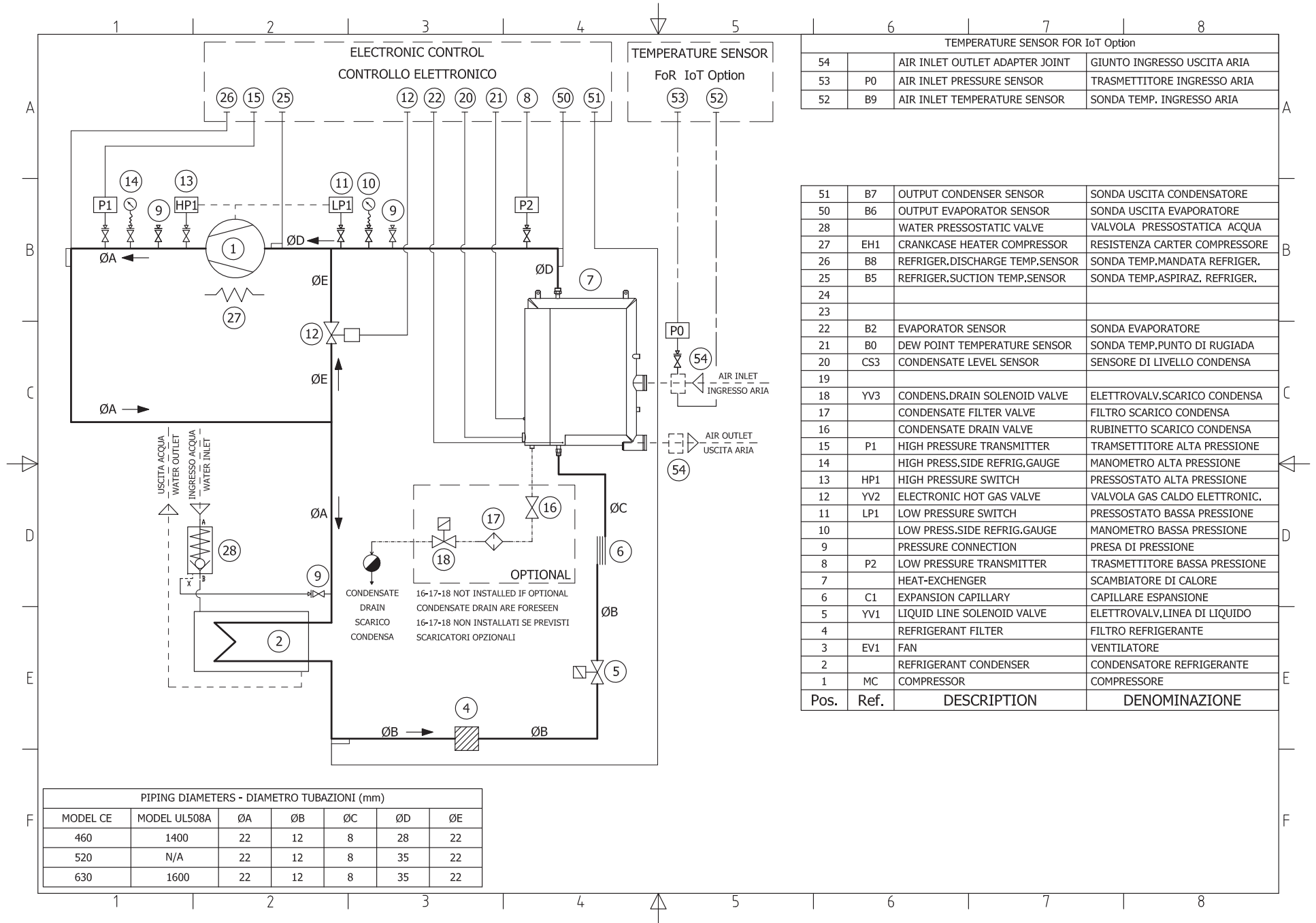

TEMPERATURE SENSOR FOR IoT Option			
54		AIR INLET OUTLET ADAPTER JOINT	GIUNTO INGRESSO USCITA ARIA
53	P0	AIR INLET PRESSURE SENSOR	TRASMETTITORE INGRESSO ARIA
52	B9	AIR INLET TEMPERATURE SENSOR	SONDA TEMP. INGRESSO ARIA

51	B7	OUTPUT CONDENSER SENSOR	SONDA USCITA CONDENSATORE
50	B6	OUTPUT EVAPORATOR SENSOR	SONDA USCITA EVAPORATORE
28		WATER PRESSOSTATIC VALVE	VALVOLA PRESSOSTATICA ACQUA
27	EH1	CRANKCASE HEATER COMPRESSOR	RESISTENZA CARTER COMPRESSORE
26	B8	REFRIGER. DISCHARGE TEMP. SENSOR	SONDA TEMP. MANDATA REFRIGER.
25	B5	REFRIGER. SUCTION TEMP. SENSOR	SONDA TEMP. ASPIRAZ. REFRIGER.
24			
23			
22	B2	EVAPORATOR SENSOR	SONDA EVAPORATORE
21	B0	DEW POINT TEMPERATURE SENSOR	SONDA TEMP. PUNTO DI RUGIADA
20	CS3	CONDENSATE LEVEL SENSOR	SENSORE DI LIVELLO CONDENSA
19			
18	YV3	CONDENS. DRAIN SOLENOID VALVE	ELETTROVALV. SCARICO CONDENSA
17		CONDENSATE FILTER VALVE	FILTRO SCARICO CONDENSA
16		CONDENSATE DRAIN VALVE	RUBINETTO SCARICO CONDENSA
15	P1	HIGH PRESSURE TRANSMITTER	TRASMETTITORE ALTA PRESSIONE
14	HP1	HIGH PRESS. SIDE REFRIG. GAUGE	MANOMETRO ALTA PRESSIONE
13	HP1	HIGH PRESSURE SWITCH	PRESSOSTATO ALTA PRESSIONE
12	YV2	ELECTRONIC HOT GAS VALVE	VALVOLA GAS CALDO ELETTRONIC.
11	LP1	LOW PRESSURE SWITCH	PRESSOSTATO BASSA PRESSIONE
10		LOW PRESS. SIDE REFRIG. GAUGE	MANOMETRO BASSA PRESSIONE
9		PRESSURE CONNECTION	PRESA DI PRESSIONE
8	P2	LOW PRESSURE TRANSMITTER	TRASMETTITORE BASSA PRESSIONE
7		HEAT-EXCHANGER	SCAMBIATORE DI CALORE
6	C1	EXPANSION CAPILLARY	CAPILLARE ESPANSIONE
5	YV1	LIQUID LINE SOLENOID VALVE	ELETTROVALV. LINEA DI LIQUIDO
4		REFRIGERANT FILTER	FILTRO REFRIGERANTE
3	EV1	FAN	VENTILATORE
2		REFRIGERANT CONDENSER	CONDENSATORE REFRIGERANTE
1	MC	COMPRESSOR	COMPRESSORE
Pos.	Ref.	DESCRIPTION	DENOMINAZIONE

8.7 REFRIGERANT CIRCUIT PSE 750-1200 Wc

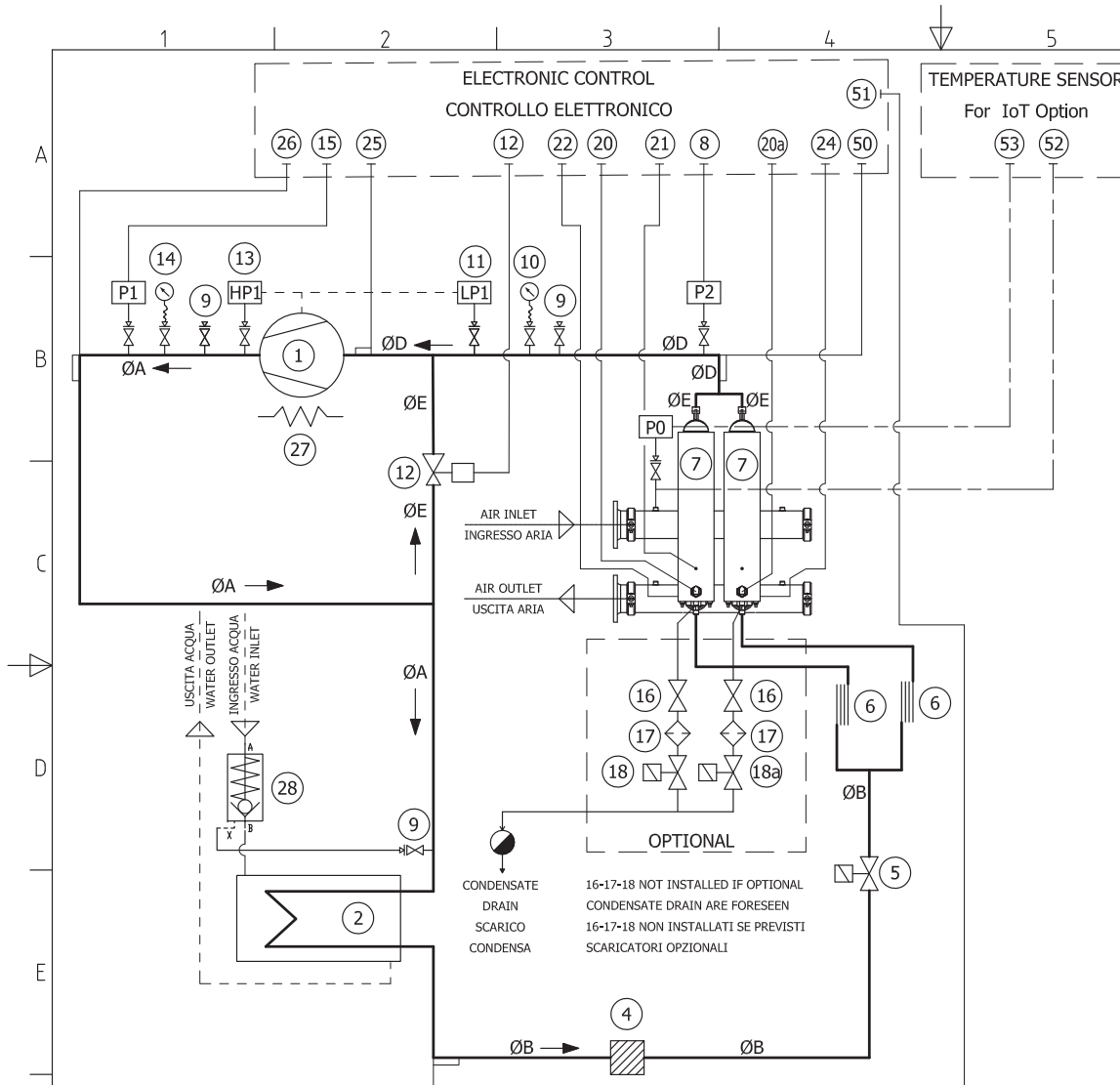

TEMPERATURE SENSOR FOR IoT OPTION			
53	P0	AIR INLET PRESSURE SENSOR	TRASMETTITORE INGRESSO ARIA
52	B9	AIR INLET TEMPERATURE SENSOR	SONDA TEMP. INGRESSO ARIA

51	B7	OUTPUT CONDENSER SENSOR	SONDA USCITA CONDENSATORE
50	B6	OUTPUT EVAPORATOR SENSOR	SONDA USCITA EVAPORATORE
28		WATER PRESSOSTATIC VALVE	VALVOLA PRESSOSTATICA ACQUA
27	EH1	CRANKCASE HEATER COMPRESSOR	RESISTENZA CARTER COMPRESSORE
26	B8	REFRIGER. DISCHARGE TEMP. SENSOR	SONDA TEMP. MANDATA REFRIGER.
25	B5	REFRIGER. SUCTION TEMP. SENSOR	SONDA TEMP. ASPIRAZ. REFRIGER.
24	B4	EVAPORATOR SENSOR (Multicooler)	SONDA EVAPORATORE (Secondo evap)
23			
22	B2	EVAPORATOR SENSOR	SONDA EVAPORATORE
21	B0	DEW POINT TEMPERATURE SENSOR	SONDA TEMP. PUNTO DI RUGIADA
20a	CS4	CONDENSATE LEVEL SENSOR	SENSORE DI LIVELLO CONDENSA
20	CS3	CONDENSATE LEVEL SENSOR	SENSORE DI LIVELLO CONDENSA
19			
18a	YV4	CONDENS. DRAIN SOLENOID VALVE	ELETTROVALV. SCARICO CONDENSA
18	YV3	CONDENS. DRAIN SOLENOID VALVE	ELETTROVALV. SCARICO CONDENSA
17		CONDENSATE FILTER VALVE	FILTRO SCARICO CONDENSA
16		CONDENSATE DRAIN VALVE	RUBINETTO SCARICO CONDENSA
15	P1	HIGH PRESSURE TRANSMITTER	TRASMETTITORE ALTA PRESSIONE
14		HIGH PRESS. SIDE REFRIG. GAUGE	MANOMETRO ALTA PRESSIONE
13	HP1	HIGH PRESSURE SWITCH	PRESSOSTATO ALTA PRESSIONE
12	YV2	ELECTRONIC HOT GAS VALVE	VALVOLA GAS CALDO ELETTRONIC.
11	LP1	LOW PRESSURE SWITCH	PRESSOSTATO BASSA PRESSIONE
10		LOW PRESS. SIDE REFRIG. GAUGE	MANOMETRO BASSA PRESSIONE
9		PRESSURE CONNECTION	PRESA DI PRESSIONE
8	P2	LOW PRESSURE TRANSMITTER	TRASMETTITORE BASSA PRESSIONE
7		HEAT-EXCHANGER	SCAMBIATORE DI CALORE
6	C1	EXPANSION CAPILLARY	CAPILLARE ESPANSIONE
5	YV1	LIQUID LINE SOLENOID VALVE	ELETTROVALV. LINEA DI LIQUIDO
4		REFRIGERANT FILTER	FILTRO REFRIGERANTE
3			
2		REFRIGERANT CONDENSER	CONDENSATORE REFRIGERANTE
1	MC	COMPRESSOR	COMPRESSORE
Pos.	Ref.	DESCRIPTION	DENOMINAZIONE

PIPING DIAMETERS - DIAMETRO TUBAZIONI (mm)

MODEL CE	MODEL UL508a	ØA	ØB	ØC	ØD	ØE
750	2000	22	12	8	28	22
900	2400	22	12	8	35	22
1200	3000-3800	22	12	8	35	22

8.7 REFRIGERANT CIRCUIT PSE 1500-1800 Wc

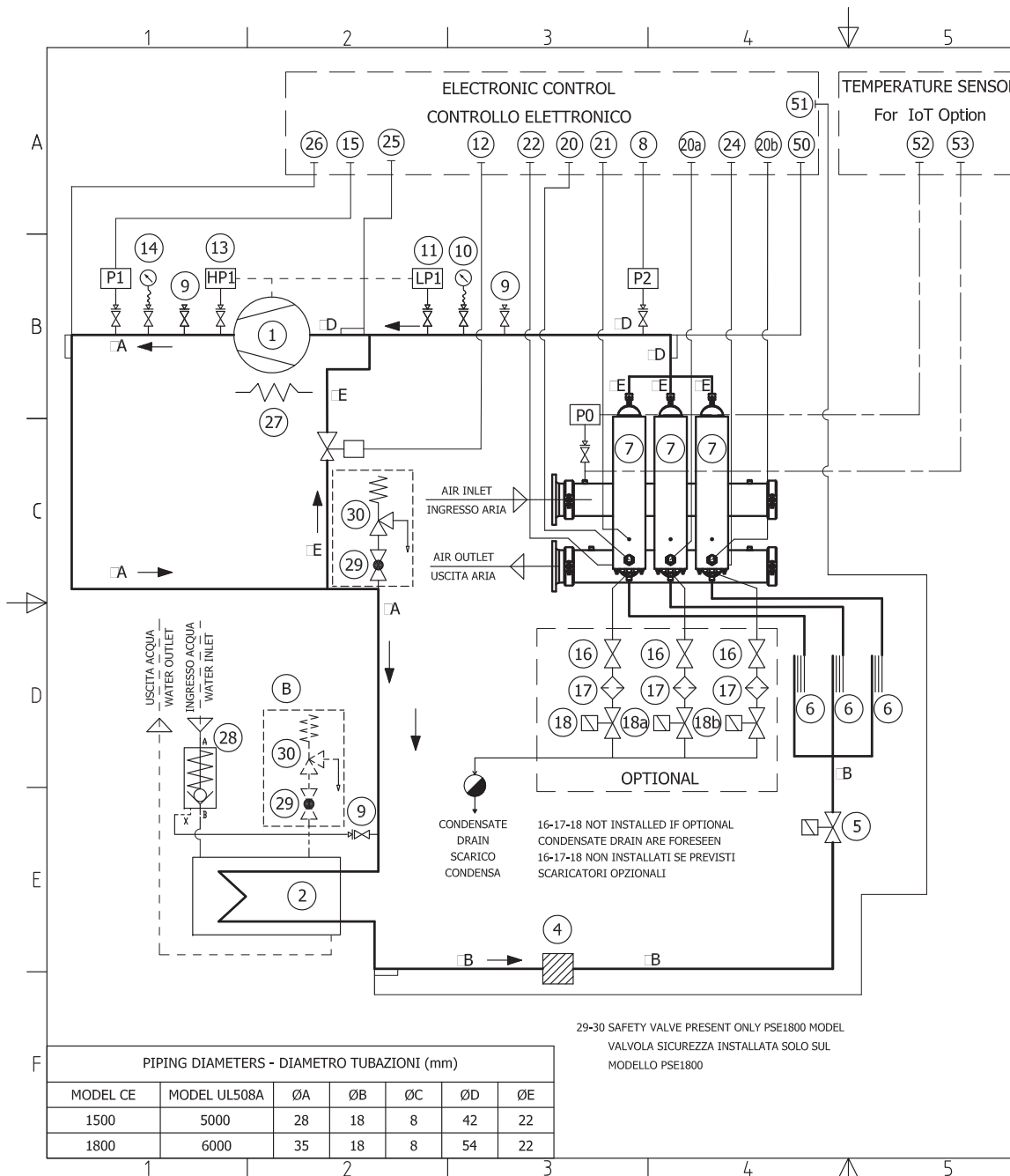

TEMPERATURE SENSOR FOR IoT OPTION			
53	P0	AIR INLET PRESSURE SENSOR	TRASMETTITORE INGRESSO ARIA
52	B9	AIR INLET TEMPERATURE SENSOR	SONDA TEMP. INGRESSO ARIA
51	B7	OUTPUT CONDENSER SENSOR	SONDA USCITA CONDENSATORE
50	B6	OUTPUT EVAPORATOR SENSOR	SONDA USCITA EVAPORATORE
30		DISCHARGE SAFETY VALVE	VALVOLA DI SICUREZZA MANDATA
29		VALVE	RUBINETTO
28			
27	EH1	CRANKCASE HEATER COMP. (Option)	RESISTENZA CARTER COMP.(Opzione)
26	B8	REFRIGER.DISCHARGE TEMP.SENSOR	SONDA TEMP.MANDATA REFRIGER.
25	B5	REFRIGER.SUCTION TEMP.SENSOR	SONDA TEMP.ASPIRAZ. REFRIGER.
24	B4	EVAPORATOR SENSOR(Multicooler)	SONDA EVAPORATORE(Secondo evap)
23			
22	B2	EVAPORATOR SENSOR	SONDA EVAPORATORE
21	B0	DEW POINT TEMPERATURE SENSOR	SONDA TEMP.PUNTO DI RUGIADA
20b	CS5	CONDENSATE LEVEL SENSOR	SENSORE DI LIVELLO CONDENSA
20a	CS4	CONDENSATE LEVEL SENSOR	SENSORE DI LIVELLO CONDENSA
20	CS3	CONDENSATE LEVEL SENSOR	SENSORE DI LIVELLO CONDENSA
19			
18b	YV5	CONDENS.DRAIN SOLENOID VALVE	ELETTROVALV.SCARICO CONDENSA
18a	YV4	CONDENS.DRAIN SOLENOID VALVE	ELETTROVALV.SCARICO CONDENSA
18	YV3	CONDENS.DRAIN SOLENOID VALVE	ELETTROVALV.SCARICO CONDENSA
17		CONDENSATE FILTER VALVE	FILTRO SCARICO CONDENSA
16		CONDENSATE DRAIN VALVE	RUBINETTO SCARICO CONDENSA
15	P1	HIGH PRESSURE TRANSMITTER	TRASMETTITORE ALTA PRESSIONE
14		HIGH PRESS.SIDE REFRIG.GAUGE	MANOMETRO ALTA PRESSIONE
13	HP1	HIGH PRESSURE SWITCH	PRESSOSTATO ALTA PRESSIONE
12	YV2	ELECTRONIC HOT GAS VALVE	VALVOLA GAS CALDO ELETTRONIC.
11	LP1	LOW PRESSURE SWITCH	PRESSOSTATO BASSA PRESSIONE
10		LOW PRESS.SIDE REFRIG.GAUGE	MANOMETRO BASSA PRESSIONE
9		PRESSURE CONNECTION	PRESA DI PRESSIONE
8	P2	LOW PRESSURE TRANSMITTER	TRASMETTITORE BASSA PRESSIONE
7		HEAT-EXCHANGER	SCAMBIATORE DI CALORE
6	C1	EXPANSION CAPILLARY	CAPILLARE ESPANSIONE
5	YV1	LIQUID LINE SOLENOID VALVE	ELETTROVALV.LINEA DI LIQUIDO
4		REFRIGERANT FILTER	FILTRO REFRIGERANTE
3			
2		REFRIGERANT CONDENSER	CONDENSATORE REFRIGERANTE
1	MC	COMPRESSOR	COMPRESSORE
Pos.	Ref.	DESCRIPTION	DENOMINAZIONE

29-30 SAFETY VALVE PRESENT ONLY PSE1800 MODEL
VALVOLA SICUREZZA INSTALLATA SOLO SUL MODELLO PSE1800

PIPING DIAMETERS - DIAMETRO TUBAZIONI (mm)

MODEL CE	MODEL UL508A	ØA	ØB	ØC	ØD	ØE
1500	5000	28	18	8	42	22
1800	6000	35	18	8	54	22

DRYER SIZE	COMPRESSOR					FAN MOTOR					CRANKCASE HEATER			AUXILIARY			
	TAG	FLA [A]	Pn		LRA [A]	TAG	FLA [A]	Pn		LRA [A]	TAG	Pn		FLA [A]	Pn [A]		FLA [A]
			kW 50Hz	kW 60Hz				kW 50Hz	kW 60Hz			kW	Hp		kW	Hp	
460	MA1	12,8	6,9	8,3	95	MA3	1,35	0,74	0,74	9,45	EH11	0,070	--	0,175	0,35	--	0,9
520		16	8,17	9,65	110												
630		19,2	9,24	10,92	140												
750		29,5	13,8	16,7	175												

GENERAL DATA / DONNÉES GENERALES				
DRYER SIZE	460	520	630	750
Pn [kW] 50/60Hz	8/9,4	9,26/10,7	10,3/12	15,4/18,3
FLA [A] 50/60Hz	14,2	17,4	21	31,6
MCA [A]	17,5	21,5	25,5	39
MOP [A]	30	35	40	65

ITEM	398H316903: 460/630 398H316904: 750
Supply Voltage Tension d'alimentation	400V - 3Ph - 50Hz 460V - 3Ph - 60Hz
Control Voltage Tension auxiliaire	24Vac / 24Vdc
Enclosed type	IP54
Residual current switch	RCCB Id 0,3A class A by customer care
Icc	6 kA
Grounding Mise à la terre	Solidly grounded
Additional Opzioni	/

ELECTRICAL SUPPLY LINE - LINEA ALIMENTAZIONE 400V/3Ph/50Hz - 460V/3Ph/60Hz
CABLES SIZE - DIMENSIONI CAVI SEE TABLE (MCA) - VEDERE TABELLA (MCA)

SH	DESCRIPTION	DESCRIZIONE
1	Electrical data	Dati tecnici
2	Electrical data	Dati tecnici
3	Power circuit	Circuito di potenza
4	Auxiliary circuits	Circuito ausiliario
5	Auxiliary circuits	Circuito ausiliario
6	Auxiliary circuits	Circuito ausiliario
7	Auxiliary circuits	Circuito ausiliario
8	Auxiliary circuits	Circuito ausiliario
9	Auxiliary circuits	Circuito ausiliario
10	Auxiliary circuits	Circuito ausiliario
11	Auxiliary circuits	Circuito ausiliario
12	Customer interface	Interfaccia cliente
13	Terminal blocks	Morsettiera
14	Terminal blocks	Morsettiera
15	Electrical panel layout	Planimetria quadro elettrico
16	Components list	Lista componenti
17	Components list	Lista componenti
18	Components list	Lista componenti
19	Fuses list	Lista fusibili
20	On machine	Bordo macchina
21	Cables list	Lista cavi
22	Cables list	Lista cavi
23	Components list	Lista cavi
24	Components list	Lista cavi
25	Cabinet	Carpenteria

	1	2	3	4	5	6	7	8																																																																											
A				<table border="1"> <thead> <tr> <th colspan="3">Designation Color in according to EN 60204-1</th> </tr> <tr> <th colspan="3">Colour Abbreviations in according to IEC 60757</th> </tr> <tr> <th>WIRING</th> <th>COLOR</th> <th>CROSS SECTION</th> </tr> </thead> <tbody> <tr> <td>Power circuit Circuito di Potenza</td> <td>BLACK - BK</td> <td rowspan="8">as circuit diagram indication</td> </tr> <tr> <td>Control line at 230-24Vac Linea di Controllo a 230-24Vac</td> <td>RED - RD</td> </tr> <tr> <td>Control line at 24Vdc Linea di Controllo a 24Vdc</td> <td>DARK BLUE - DBU</td> </tr> <tr> <td rowspan="3">Analog signal Segnali Analogici</td> <td>WHITE - WH</td> </tr> <tr> <td>VIOLET - VT</td> </tr> <tr> <td>BLUE - BU</td> </tr> <tr> <td>Potential free contact Contatti Puliti</td> <td>ORANGE - OR</td> </tr> <tr> <td>Conductor not disconnected Conduttore non sezionati</td> <td></td> </tr> <tr> <td>Ground or Earth connection Connessioni di Terra</td> <td>GREENYELLOW - GNYE</td> </tr> </tbody> </table>		Designation Color in according to EN 60204-1			Colour Abbreviations in according to IEC 60757			WIRING	COLOR	CROSS SECTION	Power circuit Circuito di Potenza	BLACK - BK	as circuit diagram indication	Control line at 230-24Vac Linea di Controllo a 230-24Vac	RED - RD	Control line at 24Vdc Linea di Controllo a 24Vdc	DARK BLUE - DBU	Analog signal Segnali Analogici	WHITE - WH	VIOLET - VT	BLUE - BU	Potential free contact Contatti Puliti	ORANGE - OR	Conductor not disconnected Conduttore non sezionati		Ground or Earth connection Connessioni di Terra	GREENYELLOW - GNYE	<table border="1"> <thead> <tr> <th colspan="3">Tightening Torque - Serrage du couple</th> </tr> <tr> <th colspan="3">DRYER SIZE 460-520</th> </tr> <tr> <th></th> <th>Nm</th> <th>In*Lb</th> </tr> </thead> <tbody> <tr> <td>QS1</td> <td>6</td> <td>53,1</td> </tr> <tr> <td>QM1</td> <td>1,7</td> <td>15,0</td> </tr> <tr> <td>QM1(aux)</td> <td>1</td> <td>8,9</td> </tr> <tr> <td>KM1</td> <td>3,2</td> <td>28,9</td> </tr> <tr> <td>KM1(aux)</td> <td>1,2</td> <td>10,6</td> </tr> <tr> <td>KM3</td> <td>1,2</td> <td>10,6</td> </tr> <tr> <td>KM3(aux)</td> <td>1,2</td> <td>10,6</td> </tr> <tr> <td>E0</td> <td>6</td> <td>53,1</td> </tr> <tr> <td>fu(10,3X38)</td> <td>2,3</td> <td>20,4</td> </tr> <tr> <td>fu(5X20)</td> <td>0,5</td> <td>4,4</td> </tr> <tr> <td>FV6</td> <td>0,8</td> <td>7,1</td> </tr> <tr> <td>A1,A2,A3(in)</td> <td>0,2</td> <td>1,8</td> </tr> <tr> <td>A1,A2,A3(out)</td> <td>0,6</td> <td>5,3</td> </tr> </tbody> </table>			Tightening Torque - Serrage du couple			DRYER SIZE 460-520				Nm	In*Lb	QS1	6	53,1	QM1	1,7	15,0	QM1(aux)	1	8,9	KM1	3,2	28,9	KM1(aux)	1,2	10,6	KM3	1,2	10,6	KM3(aux)	1,2	10,6	E0	6	53,1	fu(10,3X38)	2,3	20,4	fu(5X20)	0,5	4,4	FV6	0,8	7,1	A1,A2,A3(in)	0,2	1,8	A1,A2,A3(out)	0,6	5,3	A
Designation Color in according to EN 60204-1																																																																																			
Colour Abbreviations in according to IEC 60757																																																																																			
WIRING	COLOR	CROSS SECTION																																																																																	
Power circuit Circuito di Potenza	BLACK - BK	as circuit diagram indication																																																																																	
Control line at 230-24Vac Linea di Controllo a 230-24Vac	RED - RD																																																																																		
Control line at 24Vdc Linea di Controllo a 24Vdc	DARK BLUE - DBU																																																																																		
Analog signal Segnali Analogici	WHITE - WH																																																																																		
	VIOLET - VT																																																																																		
	BLUE - BU																																																																																		
Potential free contact Contatti Puliti	ORANGE - OR																																																																																		
Conductor not disconnected Conduttore non sezionati																																																																																			
Ground or Earth connection Connessioni di Terra	GREENYELLOW - GNYE																																																																																		
Tightening Torque - Serrage du couple																																																																																			
DRYER SIZE 460-520																																																																																			
	Nm	In*Lb																																																																																	
QS1	6	53,1																																																																																	
QM1	1,7	15,0																																																																																	
QM1(aux)	1	8,9																																																																																	
KM1	3,2	28,9																																																																																	
KM1(aux)	1,2	10,6																																																																																	
KM3	1,2	10,6																																																																																	
KM3(aux)	1,2	10,6																																																																																	
E0	6	53,1																																																																																	
fu(10,3X38)	2,3	20,4																																																																																	
fu(5X20)	0,5	4,4																																																																																	
FV6	0,8	7,1																																																																																	
A1,A2,A3(in)	0,2	1,8																																																																																	
A1,A2,A3(out)	0,6	5,3																																																																																	
B										B																																																																									
C										C																																																																									
D							<table border="1"> <thead> <tr> <th colspan="3">Tightening Torque - Serrage du couple</th> </tr> <tr> <th colspan="3">DRYER SIZE 630-1800</th> </tr> <tr> <th></th> <th>Nm</th> <th>In*Lb</th> </tr> </thead> <tbody> <tr> <td>QS1</td> <td>6</td> <td>53,1</td> </tr> <tr> <td>QM1</td> <td>3,3</td> <td>29,2</td> </tr> <tr> <td>QM1(aux)</td> <td>1</td> <td>8,9</td> </tr> <tr> <td>KM1</td> <td>3,3</td> <td>29,2</td> </tr> <tr> <td>KM1(aux)</td> <td>1,2</td> <td>10,6</td> </tr> <tr> <td>KM3</td> <td>1,2</td> <td>10,6</td> </tr> <tr> <td>KM3(aux)</td> <td>1,2</td> <td>10,6</td> </tr> <tr> <td>E0</td> <td>6</td> <td>53,1</td> </tr> <tr> <td>fu(10,3X38)</td> <td>2,3</td> <td>20,4</td> </tr> <tr> <td>fu(5X20)</td> <td>0,5</td> <td>4,4</td> </tr> <tr> <td>FV6</td> <td>0,8</td> <td>7,1</td> </tr> <tr> <td>A1,A2,A3(in)</td> <td>0,2</td> <td>1,8</td> </tr> <tr> <td>A1,A2,A3(out)</td> <td>0,6</td> <td>5,3</td> </tr> </tbody> </table>			Tightening Torque - Serrage du couple			DRYER SIZE 630-1800				Nm	In*Lb	QS1	6	53,1	QM1	3,3	29,2	QM1(aux)	1	8,9	KM1	3,3	29,2	KM1(aux)	1,2	10,6	KM3	1,2	10,6	KM3(aux)	1,2	10,6	E0	6	53,1	fu(10,3X38)	2,3	20,4	fu(5X20)	0,5	4,4	FV6	0,8	7,1	A1,A2,A3(in)	0,2	1,8	A1,A2,A3(out)	0,6	5,3	D																									
Tightening Torque - Serrage du couple																																																																																			
DRYER SIZE 630-1800																																																																																			
	Nm	In*Lb																																																																																	
QS1	6	53,1																																																																																	
QM1	3,3	29,2																																																																																	
QM1(aux)	1	8,9																																																																																	
KM1	3,3	29,2																																																																																	
KM1(aux)	1,2	10,6																																																																																	
KM3	1,2	10,6																																																																																	
KM3(aux)	1,2	10,6																																																																																	
E0	6	53,1																																																																																	
fu(10,3X38)	2,3	20,4																																																																																	
fu(5X20)	0,5	4,4																																																																																	
FV6	0,8	7,1																																																																																	
A1,A2,A3(in)	0,2	1,8																																																																																	
A1,A2,A3(out)	0,6	5,3																																																																																	
E										E																																																																									
F										F																																																																									
	1	2	3	4	5	6	7	8																																																																											

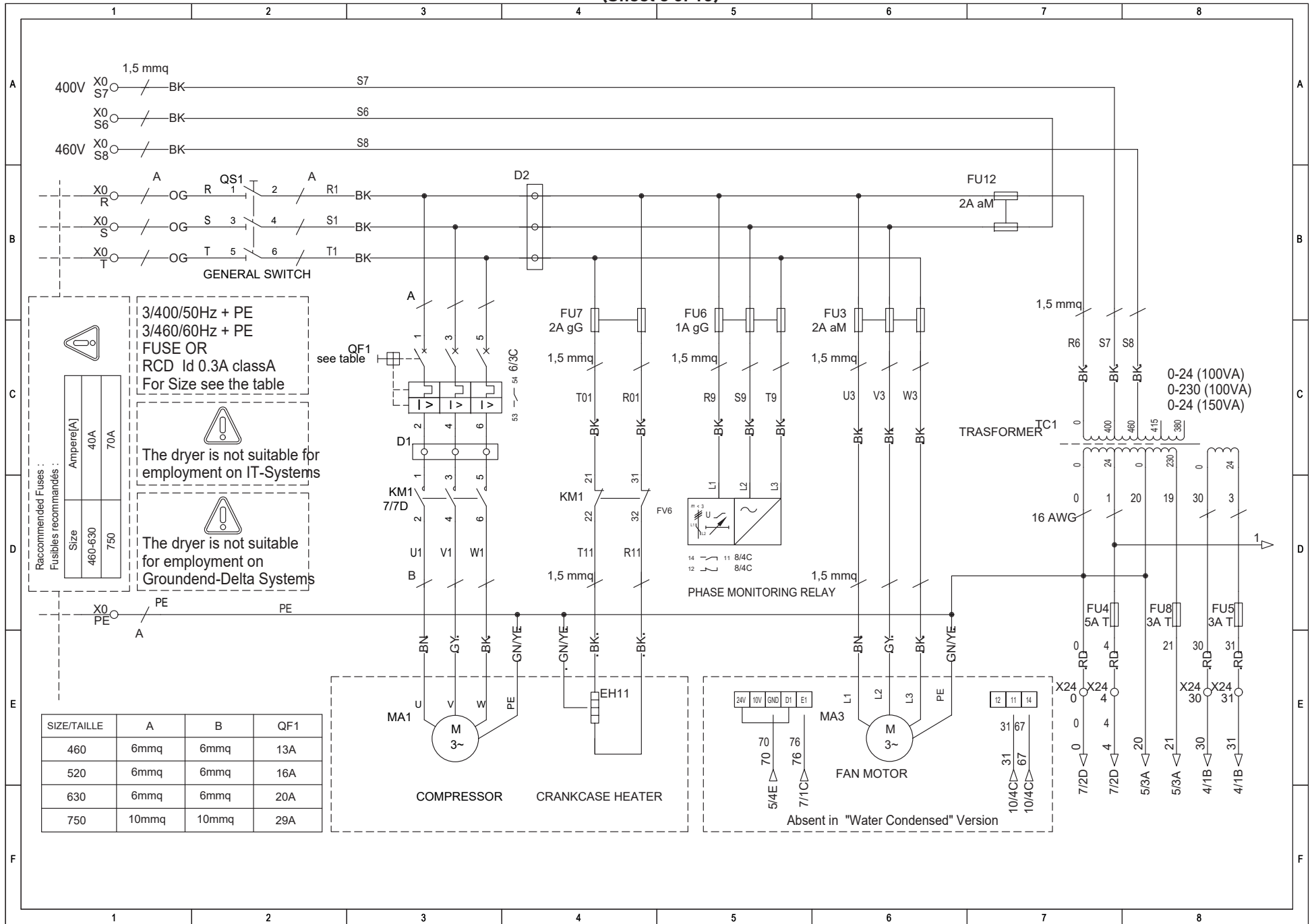

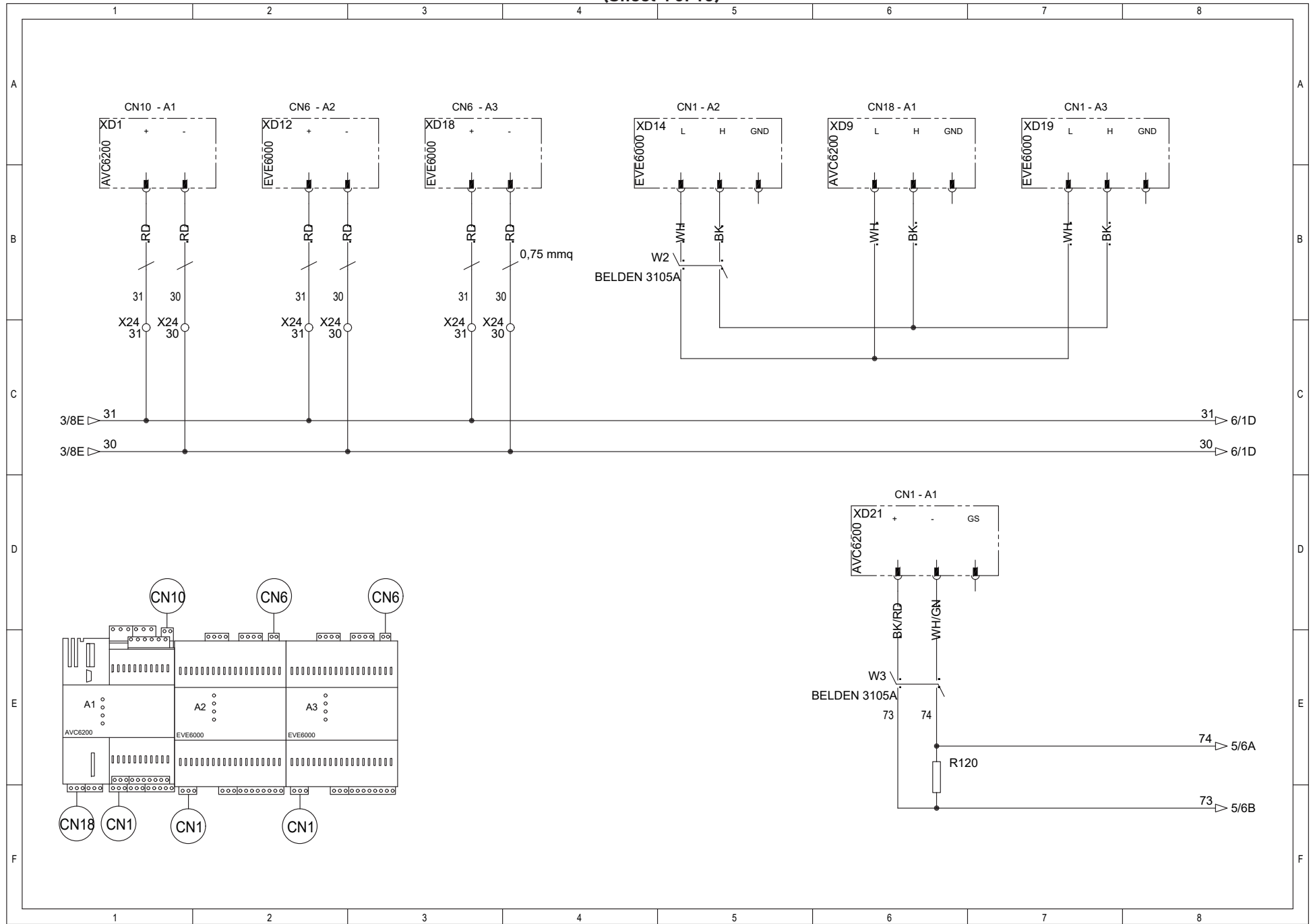

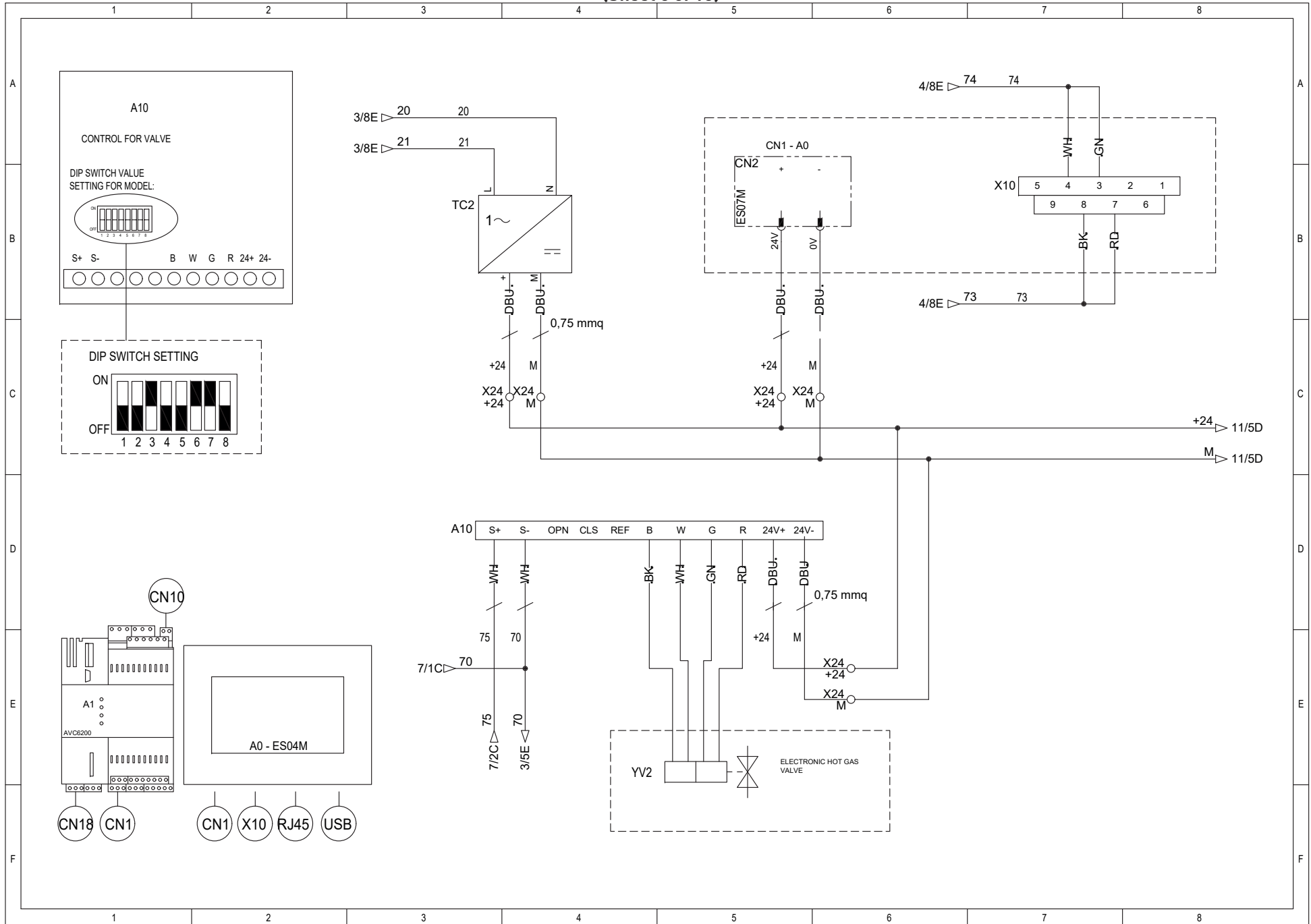

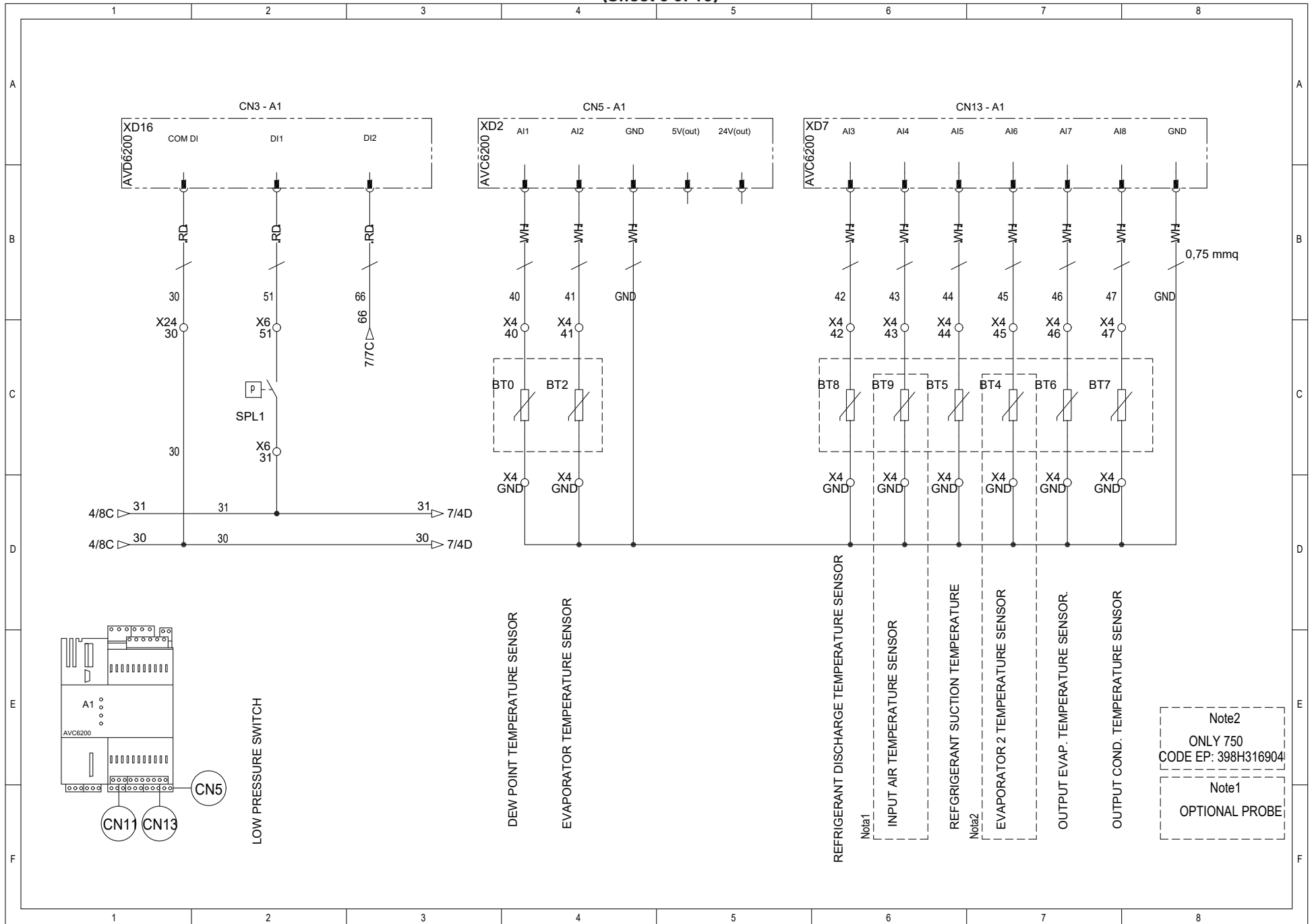

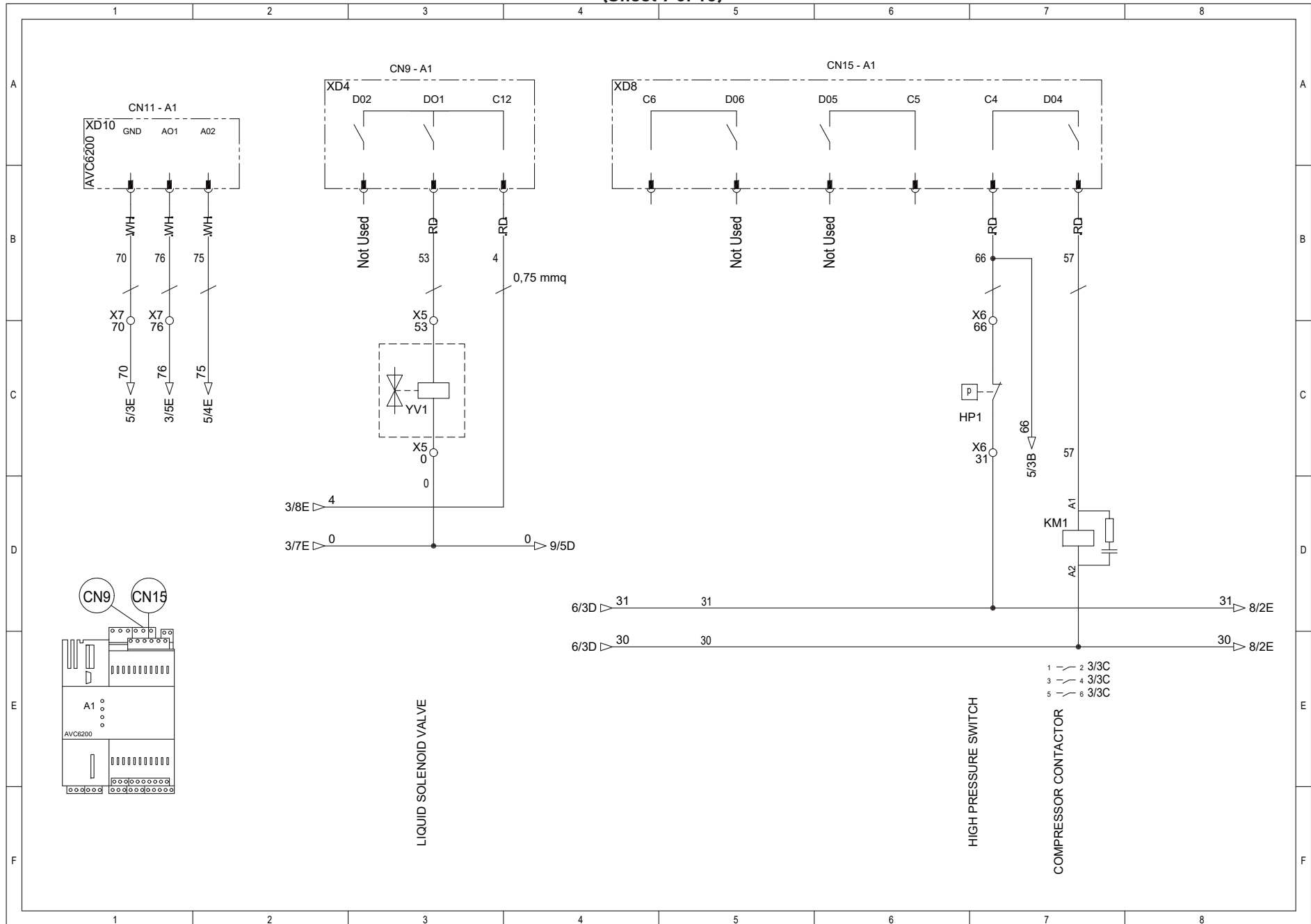

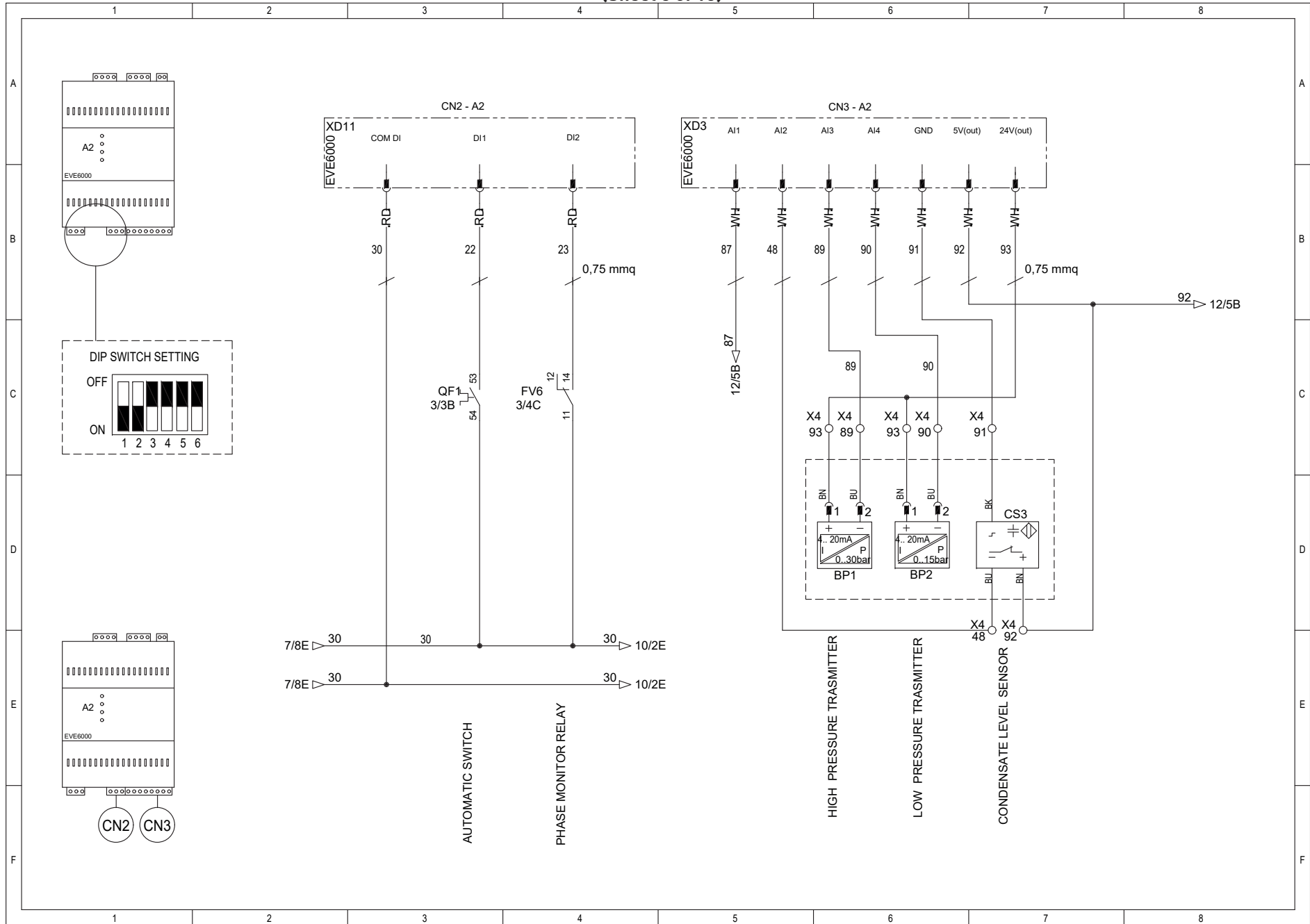

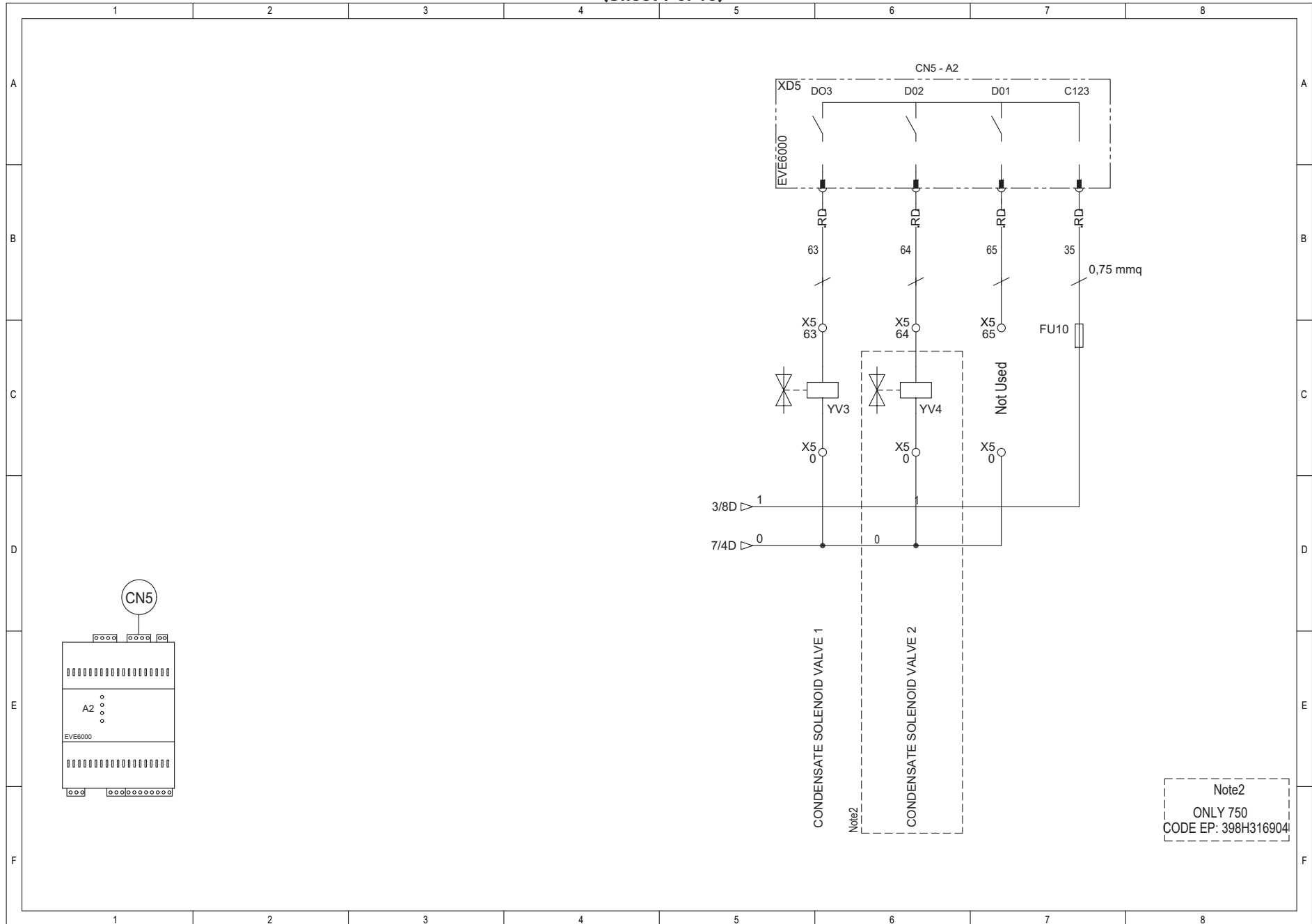

8.8 WIRING DIAGRAM PSE 460-750

(Sheet 10 of 15)

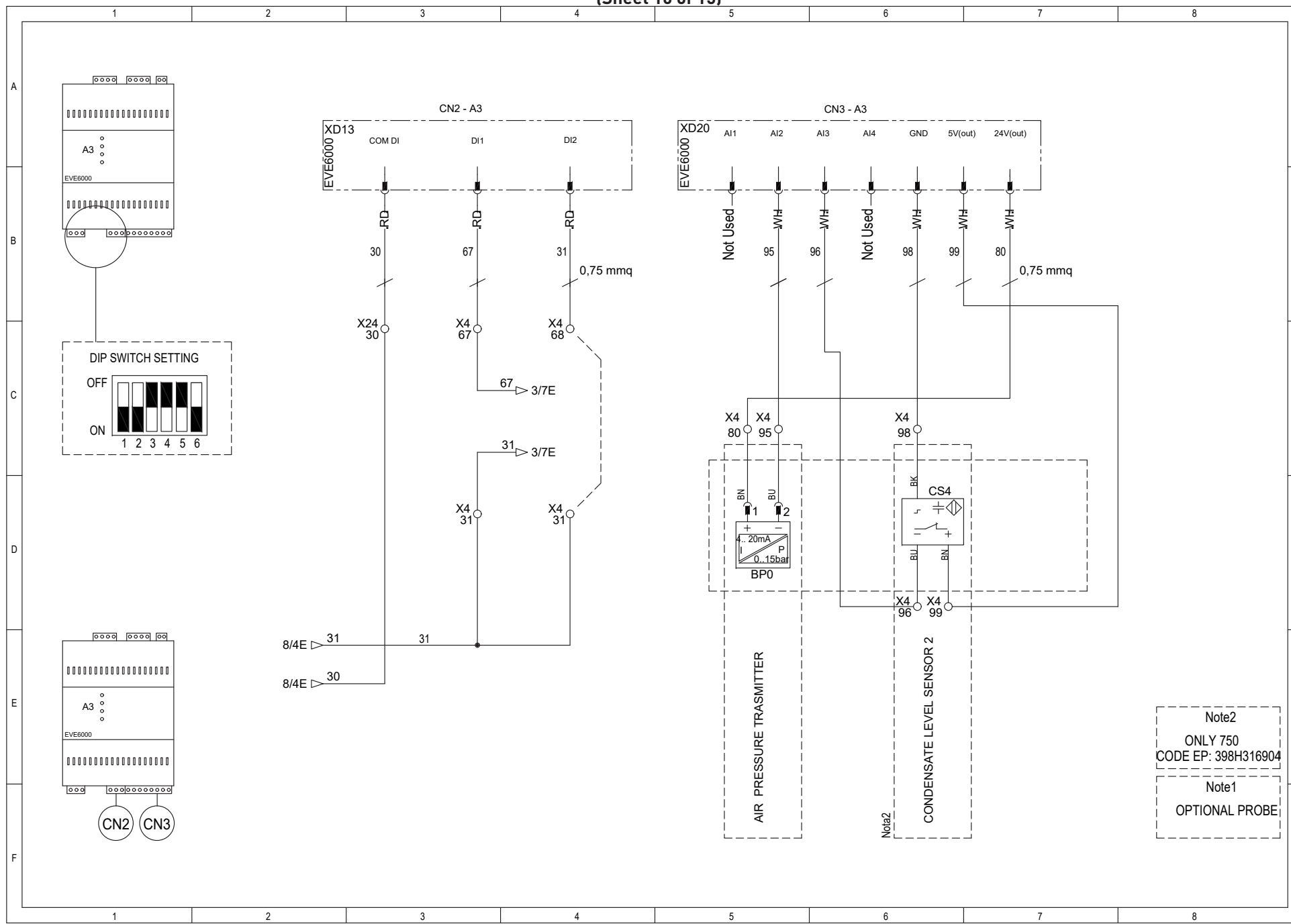

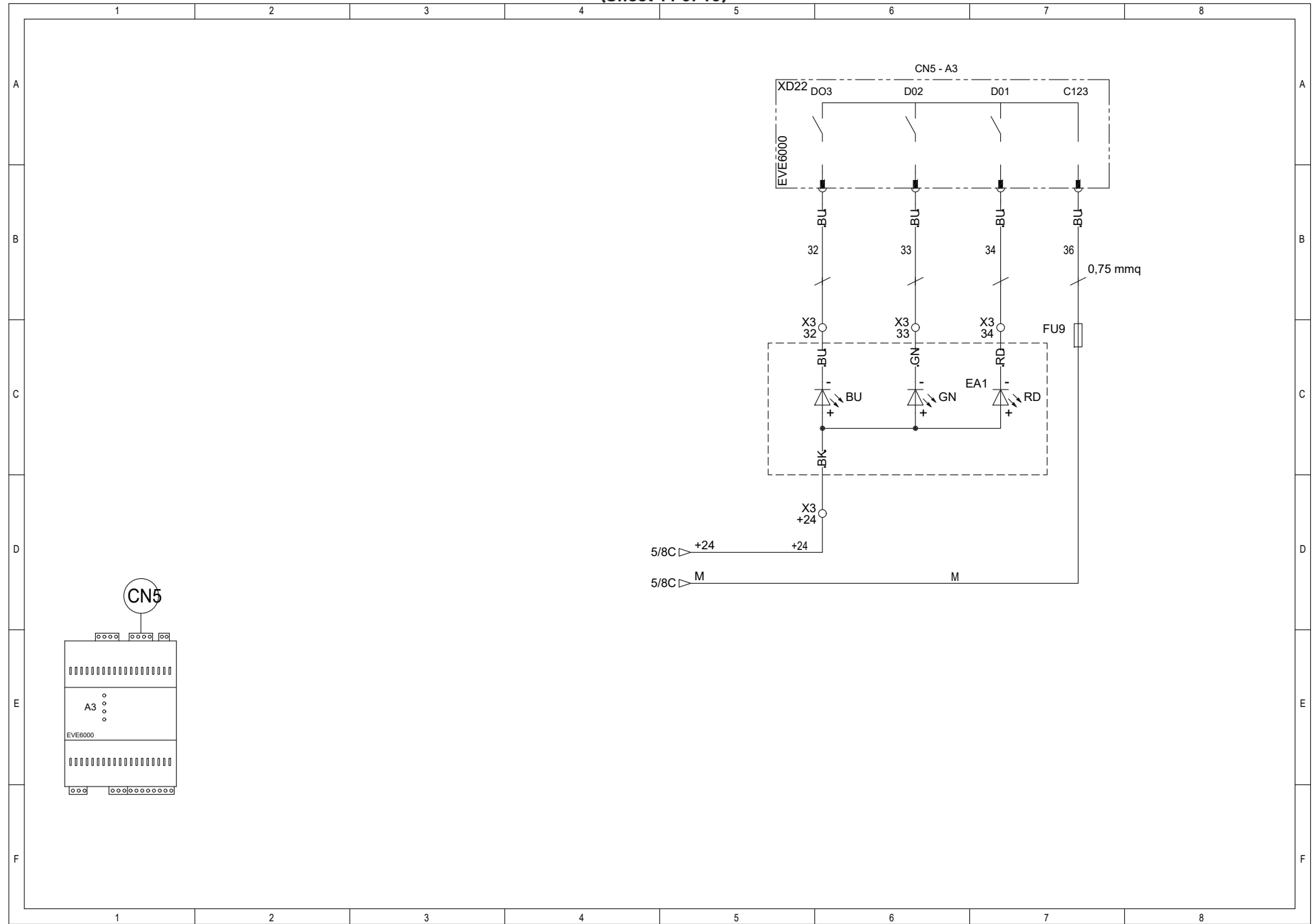

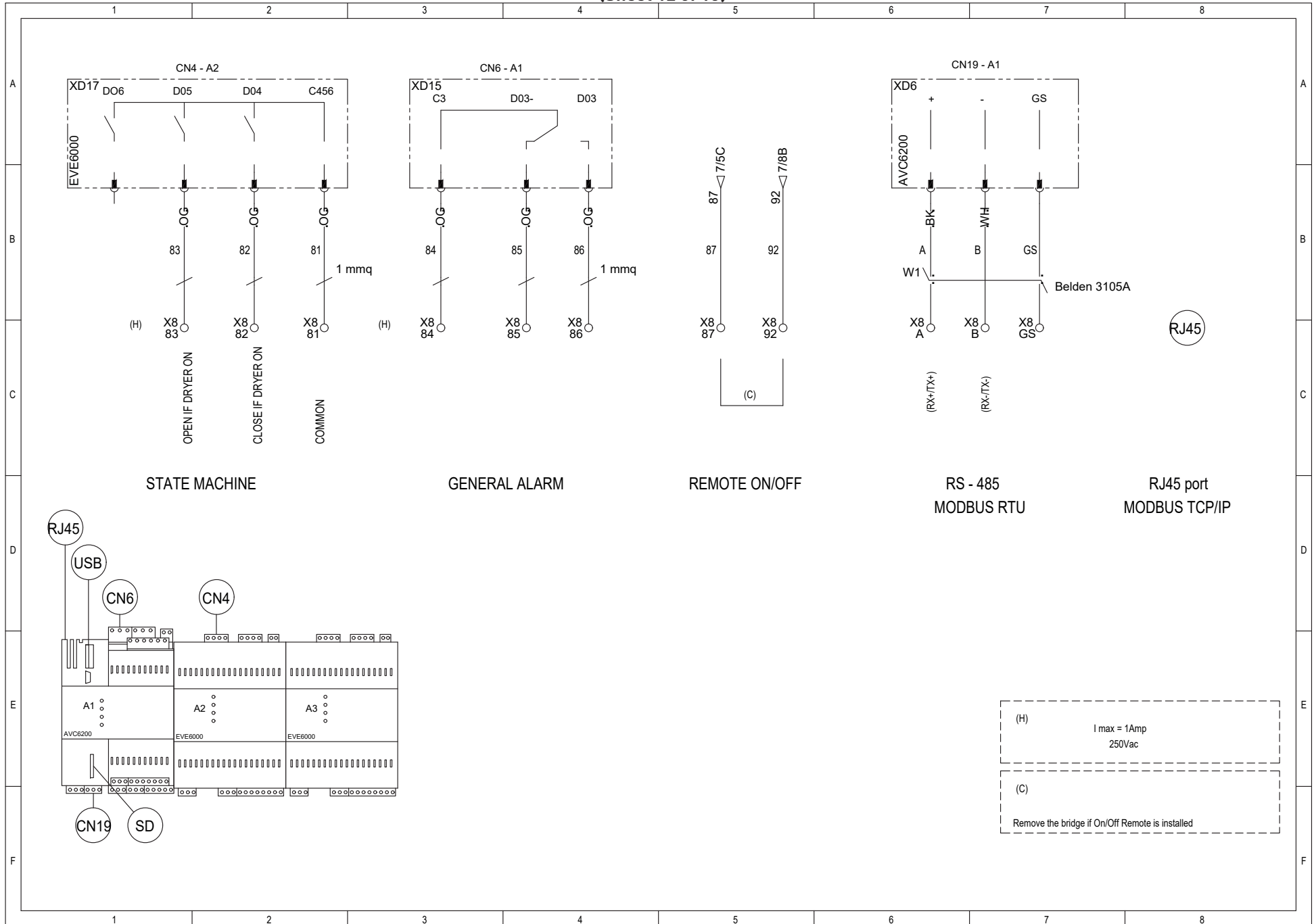

	1	2	3	4	5	6	7	8
A	PHOENIX CONTACT	PTT 1.5 PTT 1.5	PTT 2.5 PTT 2.5 PTT 2.5	PTT 1.5 PTT 1.5 PTT 1.5 PTT 1.5 PTT 1.5 PTT 1.5 PTT 1.5 PTT 1.5 PTT 1.5 PTT 1.5	PTT 2.5 PTT 2.5 PTT 2.5 PTT 2.5	PT 2.5 PT 2.5	PT 2.5 PT 2.5 PT 2.5 PT 2.5 PT 2.5 PT 2.5 PT 2.5 PT 2.5 PT 2.5 PT 2.5	PT 2.5 PT 2.5 PT 2.5 PT 2.5 PT 2.5 PT 2.5 PT 2.5 PT 2.5 PT 2.5 PT 2.5
				398H316903 : 460/630				
B	Terminal Block	X3	X5	X4	X6	X24	X8	X0
	Terminal	32 33 2	53 63 64	40 41 42 43 44 45 46 47 48 91 92 96 98 99 98 89 89 90 90 95	66 51 68 67	24 24 M M M M 30 30 30 30 31 31 31 0 4	87 92 A B GS GS	81 81 81 82 83 S8 S6 S7 T S R R PE PE
	level down							
	link down							
	level up							
	link up							
	wire up	BU BK	63 63 64	WH WH WH WH WH WH WH BU BK	66 51 68 67	24 24 M M M M 30 30 30 30 31 31 31 0 4		
	wire down	RD GN	0 0 x	BK BK BK BK BK BK BK BK BN BN x x BP1 BN BP2 BN BP0	31 31 31 31	70 76 76 76 24 24 M M M M 30 30 30 30 31 31 31 0 4		
C		EA1 EA1	YV1 YV3 x	BT0 BT2 BT8 BT9 BT5 x BT6 BT7 SL1 SL1 x x BP1 BN BP2 BN BP0	SPH1 SPL1 x MA3	MA3	RO RO A+ B- GS	C NC NO 400 C 460
D		stripled	liquid solenoid valve condensate drain valve 1 spare	ADS inlet temperature evaporator temperature refrigerant discharge temperature inlet air temperature refrigerant suction temperature spare outlet evaporator temperature outlet condensator temperature condensate level sensor condensate level sensor spare spare high pressure trasmitter low pressure trasmitter low pressure trasmitter	refrigerant high pressure switch refrigerant low pressure switch spare fan motor internal protection fan speed control		remote ON/OFF remote ON/OFF	plant status relay general alarm relay
							Modbus RTU su RS485	aux. Voltage supply bridge
								power line
F								
	1	2	3	4	5	6	7	8

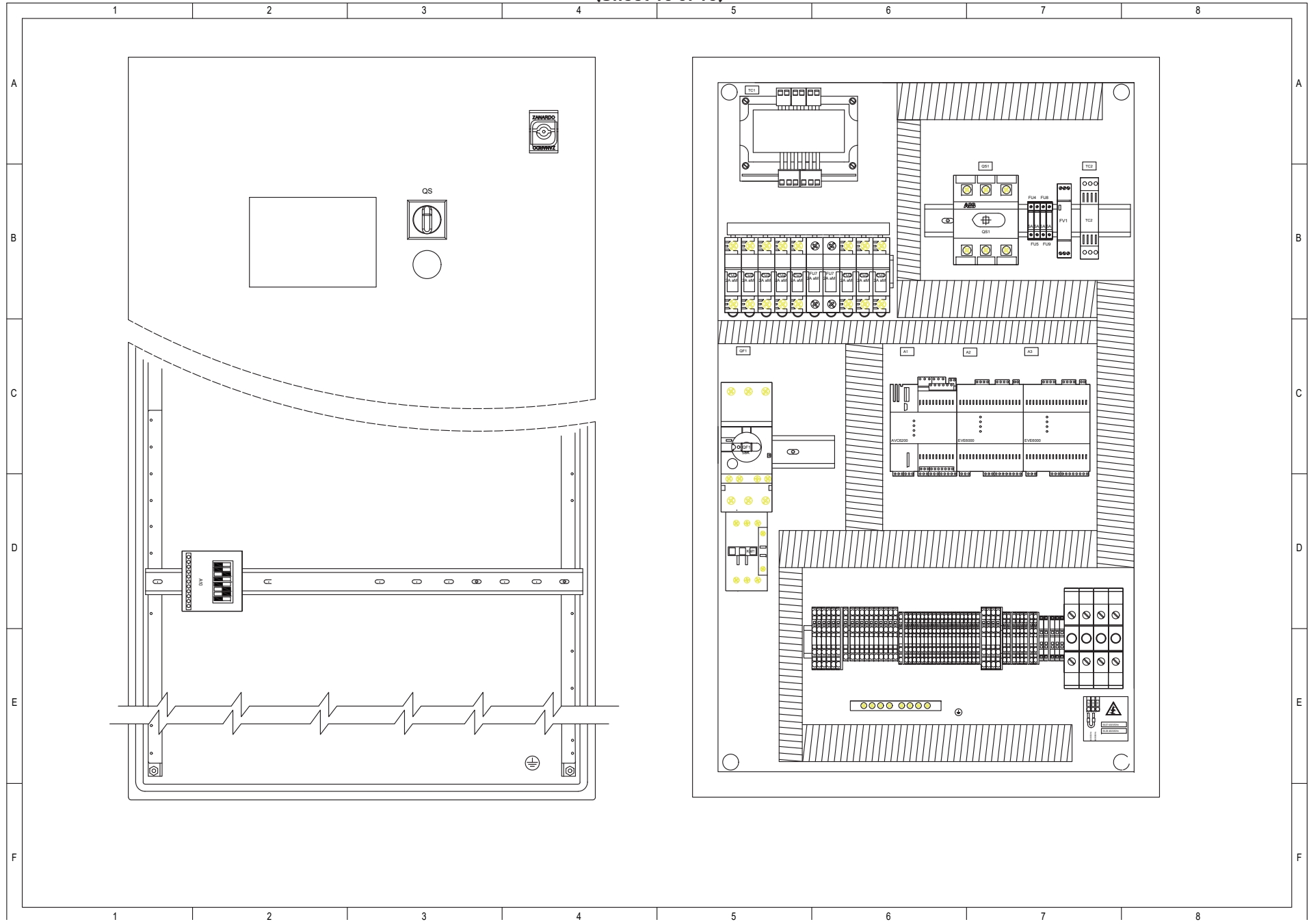

8.8 WIRING DIAGRAM PSE 900-1800

(Sheet 1 of 15)

DRYER SIZE	COMPRESSOR					FAN MOTOR					CRANKCASE HEATER			AUXILIARY					
	TAG	FLA [A]	Pn		LRA [A]	TAG	FLA [A]	Pn		LRA [A]	TAG	Pn		FLA [A]	Pn [A]		FLA [A]		
			kW 50Hz	kW 60Hz				kW 50Hz	kW 60Hz			kW	Hp		kW	Hp			
900	MA1	35,7	18,9	22,98	215	MA3	2,1	1,25	1,25	14,7	EH11	0,130	--	0,325	0,35	--	0,9		
1200			24,36	29,17				270	1,85									1,85	21
1500			49,3	27,98				33,26	300										
1800			56,4	27,98				33,26	300										

GENERAL DATA / DONNÉES GÉNÉRALES

DRYER SIZE	900	1200	1500	1800
Pn [kW] 50/60Hz	20,5/24,6	20,5/24,6	26,6/31,4	30,2/35,5
FLA [A] 50/60Hz	37,8	37,8	52,3	59,4
MCA [A]	47	47	65	74
MOP [A]	80	80	110	125

ITEM	398H316905: 900/1200 398H316906: 1500/1800
Supply Voltage Tension d'alimentation	400V - 3Ph - 50Hz 460V - 3Ph - 60Hz
Control Voltage Tension auxiliaire	24Vac / 24Vdc
Enclosed type	IP54
Residual current switch	RCCB - Id 0.3A class A by customer care
Icc	6 kA
Grounding Mise à la terre	Solidly grounded
Additional Opzioni	/

ELECTRICAL SUPPLY LINE - LINEA ALIMENTAZIONE
400V/3Ph/50Hz - 460V/3Ph/60Hz

CABLES SIZE - DIMENSIONI CAVI
SEE TABLE (MCA) - VEDERE TABELLA (MCA)

SH	DESCRIPTION	DESCRIZIONE
1	Electrical data	Dati tecnici
2	Electrical data	Dati tecnici
3	Power circuit	Circuito di potenza
4	Auxiliary circuits	Circuito ausiliario
5	Auxiliary circuits	Circuito ausiliario
6	Auxiliary circuits	Circuito ausiliario
7	Auxiliary circuits	Circuito ausiliario
8	Auxiliary circuits	Circuito ausiliario
9	Auxiliary circuits	Circuito ausiliario
10	Auxiliary circuits	Circuito ausiliario
11	Auxiliary circuits	Circuito ausiliario
12	Customer interface	Interfaccia cliente
13	Terminal blocks	Morsettiera
14	Terminal blocks	Morsettiera
15	Electrical panel layout	Planimetria quadro elettrico
16	Components list	Lista componenti
17	Components list	Lista componenti
18	Components list	Lista componenti
19	Fuses list	Lista fusibili
20	On machine	Bordo macchina
21	Cables list	Lista cavi
22	Cables list	Lista cavi
23	Cables list	Lista cavi
24	Cables list	Lista cavi
25	Cabinet	Carpenteria

	1	2	3	4	5	6	7	8																																																																											
A				<table border="1"> <thead> <tr> <th colspan="3">Designation Color in according to EN 60204-1</th> </tr> <tr> <th colspan="3">Colour Abbreviations in according to IEC 60757</th> </tr> <tr> <th>WIRING</th> <th>COLOR</th> <th>CROSS SECTION</th> </tr> </thead> <tbody> <tr> <td>Power circuit Circuito di Potenza</td> <td>BLACK - BK</td> <td rowspan="8">as circuit diagram indication</td> </tr> <tr> <td>Control line at 230-24Vac Linea di Controllo a 230-24Vac</td> <td>RED - RD</td> </tr> <tr> <td>Control line at 24Vdc Linea di Controllo a 24Vdc</td> <td>DARK BLUE - DBU</td> </tr> <tr> <td rowspan="3">Analog signal Segnali Analogici</td> <td>WHITE - WH</td> </tr> <tr> <td>VIOLET - VT</td> </tr> <tr> <td>BLUE - BU</td> </tr> <tr> <td>Potential free contact Contatti Puliti</td> <td>ORANGE - OR</td> </tr> <tr> <td>Conductor not disconnected Conduttore non sezionati</td> <td></td> </tr> <tr> <td>Ground or Earth connection Conessioni di Terra</td> <td>GREEN/YELLOW - GN/YE</td> </tr> </tbody> </table>		Designation Color in according to EN 60204-1			Colour Abbreviations in according to IEC 60757			WIRING	COLOR	CROSS SECTION	Power circuit Circuito di Potenza	BLACK - BK	as circuit diagram indication	Control line at 230-24Vac Linea di Controllo a 230-24Vac	RED - RD	Control line at 24Vdc Linea di Controllo a 24Vdc	DARK BLUE - DBU	Analog signal Segnali Analogici	WHITE - WH	VIOLET - VT	BLUE - BU	Potential free contact Contatti Puliti	ORANGE - OR	Conductor not disconnected Conduttore non sezionati		Ground or Earth connection Conessioni di Terra	GREEN/YELLOW - GN/YE	<table border="1"> <thead> <tr> <th colspan="3">Tightening Torque - Serrage du couple</th> </tr> <tr> <th colspan="3">DRYER SIZE 460-520</th> </tr> <tr> <th></th> <th>Nm</th> <th>In*Lb</th> </tr> </thead> <tbody> <tr> <td>QS1</td> <td>6</td> <td>53,1</td> </tr> <tr> <td>QM1</td> <td>1,7</td> <td>15,0</td> </tr> <tr> <td>QM1(aux)</td> <td>1</td> <td>8,9</td> </tr> <tr> <td>KM1</td> <td>3,2</td> <td>28,9</td> </tr> <tr> <td>KM1(aux)</td> <td>1,2</td> <td>10,6</td> </tr> <tr> <td>KM3</td> <td>1,2</td> <td>10,6</td> </tr> <tr> <td>KM3(aux)</td> <td>1,2</td> <td>10,6</td> </tr> <tr> <td>E0</td> <td>6</td> <td>53,1</td> </tr> <tr> <td>fu(10,3X38)</td> <td>2,3</td> <td>20,4</td> </tr> <tr> <td>fu(5X20)</td> <td>0,5</td> <td>4,4</td> </tr> <tr> <td>FV6</td> <td>0,8</td> <td>7,1</td> </tr> <tr> <td>A1,A2,A3(in)</td> <td>0,2</td> <td>1,8</td> </tr> <tr> <td>A1,A2,A3(out)</td> <td>0,6</td> <td>5,3</td> </tr> </tbody> </table>			Tightening Torque - Serrage du couple			DRYER SIZE 460-520				Nm	In*Lb	QS1	6	53,1	QM1	1,7	15,0	QM1(aux)	1	8,9	KM1	3,2	28,9	KM1(aux)	1,2	10,6	KM3	1,2	10,6	KM3(aux)	1,2	10,6	E0	6	53,1	fu(10,3X38)	2,3	20,4	fu(5X20)	0,5	4,4	FV6	0,8	7,1	A1,A2,A3(in)	0,2	1,8	A1,A2,A3(out)	0,6	5,3	A
Designation Color in according to EN 60204-1																																																																																			
Colour Abbreviations in according to IEC 60757																																																																																			
WIRING	COLOR	CROSS SECTION																																																																																	
Power circuit Circuito di Potenza	BLACK - BK	as circuit diagram indication																																																																																	
Control line at 230-24Vac Linea di Controllo a 230-24Vac	RED - RD																																																																																		
Control line at 24Vdc Linea di Controllo a 24Vdc	DARK BLUE - DBU																																																																																		
Analog signal Segnali Analogici	WHITE - WH																																																																																		
	VIOLET - VT																																																																																		
	BLUE - BU																																																																																		
Potential free contact Contatti Puliti	ORANGE - OR																																																																																		
Conductor not disconnected Conduttore non sezionati																																																																																			
Ground or Earth connection Conessioni di Terra	GREEN/YELLOW - GN/YE																																																																																		
Tightening Torque - Serrage du couple																																																																																			
DRYER SIZE 460-520																																																																																			
	Nm	In*Lb																																																																																	
QS1	6	53,1																																																																																	
QM1	1,7	15,0																																																																																	
QM1(aux)	1	8,9																																																																																	
KM1	3,2	28,9																																																																																	
KM1(aux)	1,2	10,6																																																																																	
KM3	1,2	10,6																																																																																	
KM3(aux)	1,2	10,6																																																																																	
E0	6	53,1																																																																																	
fu(10,3X38)	2,3	20,4																																																																																	
fu(5X20)	0,5	4,4																																																																																	
FV6	0,8	7,1																																																																																	
A1,A2,A3(in)	0,2	1,8																																																																																	
A1,A2,A3(out)	0,6	5,3																																																																																	
B										B																																																																									
C										C																																																																									
D							<table border="1"> <thead> <tr> <th colspan="3">Tightening Torque - Serrage du couple</th> </tr> <tr> <th colspan="3">DRYER SIZE 630-1800</th> </tr> <tr> <th></th> <th>Nm</th> <th>In*Lb</th> </tr> </thead> <tbody> <tr> <td>QS1</td> <td>6</td> <td>53,1</td> </tr> <tr> <td>QM1</td> <td>3,3</td> <td>29,2</td> </tr> <tr> <td>QM1(aux)</td> <td>1</td> <td>8,9</td> </tr> <tr> <td>KM1</td> <td>3,3</td> <td>29,2</td> </tr> <tr> <td>KM1(aux)</td> <td>1,2</td> <td>10,6</td> </tr> <tr> <td>KM3</td> <td>1,2</td> <td>10,6</td> </tr> <tr> <td>KM3(aux)</td> <td>1,2</td> <td>10,6</td> </tr> <tr> <td>E0</td> <td>6</td> <td>53,1</td> </tr> <tr> <td>fu(10,3X38)</td> <td>2,3</td> <td>20,4</td> </tr> <tr> <td>fu(5X20)</td> <td>0,5</td> <td>4,4</td> </tr> <tr> <td>FV6</td> <td>0,8</td> <td>7,1</td> </tr> <tr> <td>A1,A2,A3(in)</td> <td>0,2</td> <td>1,8</td> </tr> <tr> <td>A1,A2,A3(out)</td> <td>0,6</td> <td>5,3</td> </tr> </tbody> </table>			Tightening Torque - Serrage du couple			DRYER SIZE 630-1800				Nm	In*Lb	QS1	6	53,1	QM1	3,3	29,2	QM1(aux)	1	8,9	KM1	3,3	29,2	KM1(aux)	1,2	10,6	KM3	1,2	10,6	KM3(aux)	1,2	10,6	E0	6	53,1	fu(10,3X38)	2,3	20,4	fu(5X20)	0,5	4,4	FV6	0,8	7,1	A1,A2,A3(in)	0,2	1,8	A1,A2,A3(out)	0,6	5,3	D																									
Tightening Torque - Serrage du couple																																																																																			
DRYER SIZE 630-1800																																																																																			
	Nm	In*Lb																																																																																	
QS1	6	53,1																																																																																	
QM1	3,3	29,2																																																																																	
QM1(aux)	1	8,9																																																																																	
KM1	3,3	29,2																																																																																	
KM1(aux)	1,2	10,6																																																																																	
KM3	1,2	10,6																																																																																	
KM3(aux)	1,2	10,6																																																																																	
E0	6	53,1																																																																																	
fu(10,3X38)	2,3	20,4																																																																																	
fu(5X20)	0,5	4,4																																																																																	
FV6	0,8	7,1																																																																																	
A1,A2,A3(in)	0,2	1,8																																																																																	
A1,A2,A3(out)	0,6	5,3																																																																																	
E										E																																																																									
F										F																																																																									
	1	2	3	4	5	6	7	8																																																																											

8.8 WIRING DIAGRAM PSE 900-1800

(Sheet 3 of 15)

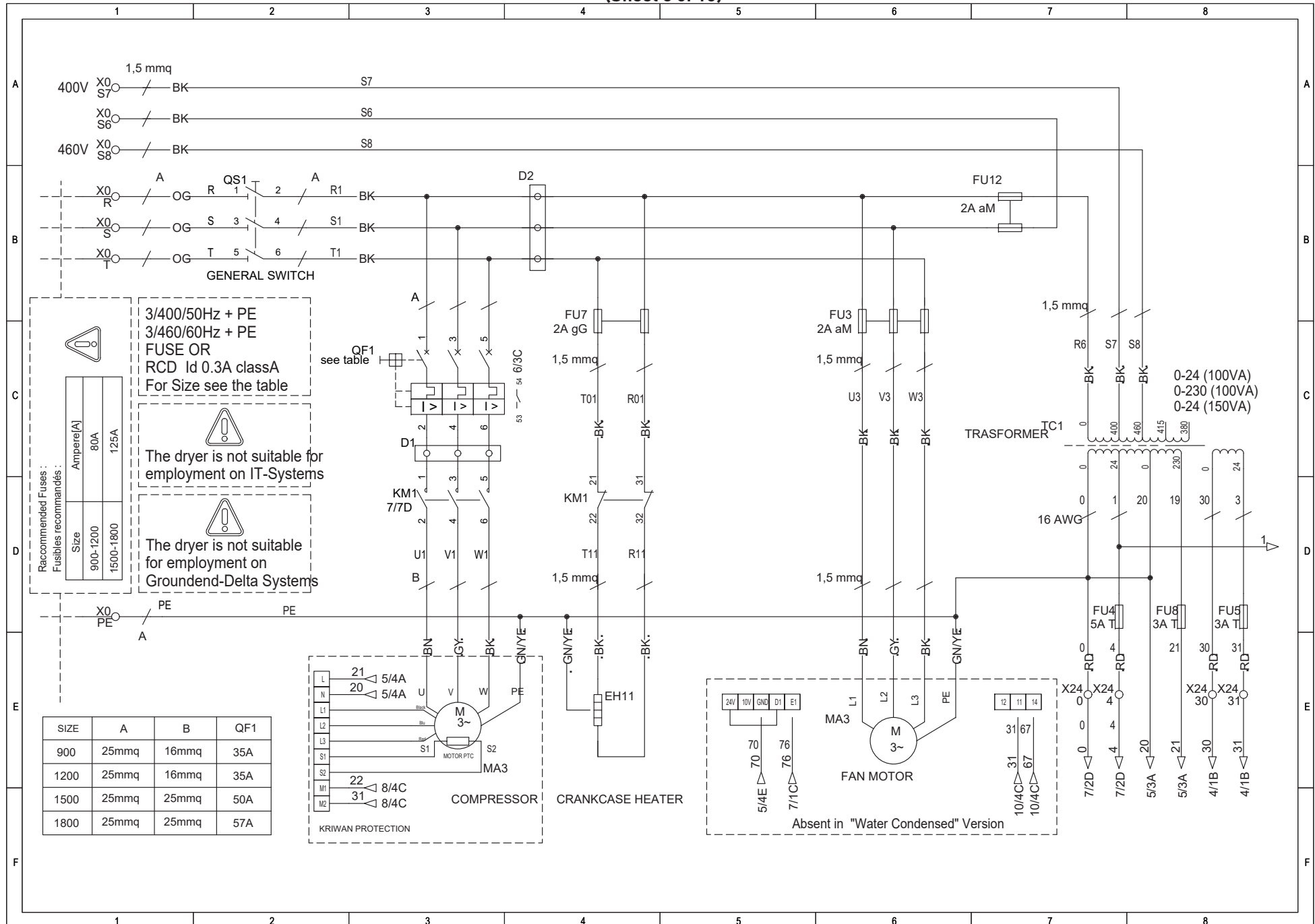

8.8 WIRING DIAGRAM PSE 900-1800

(Sheet 4 of 15)

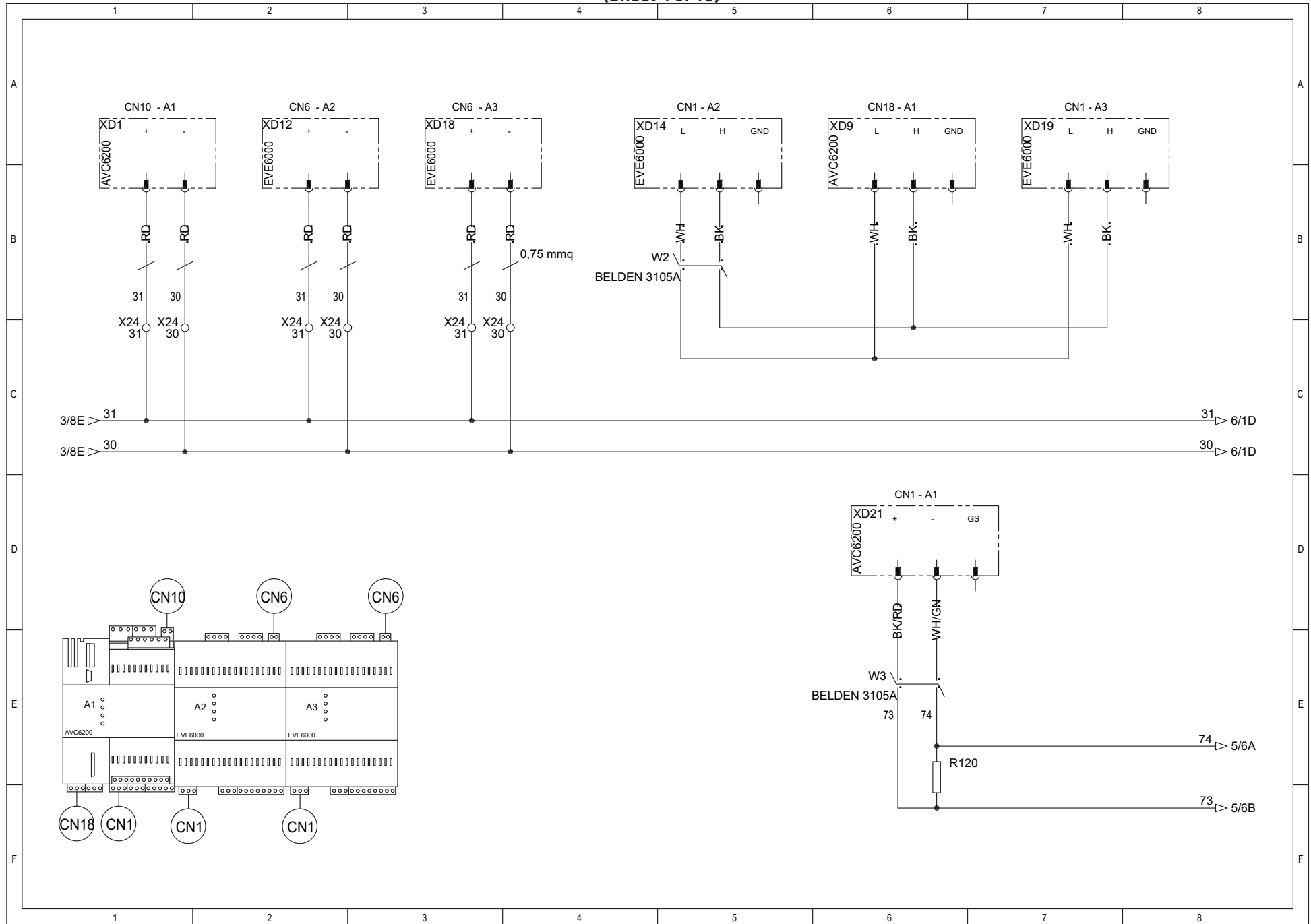

8.8 WIRING DIAGRAM PSE 900-1800

(Sheet 5 of 15)

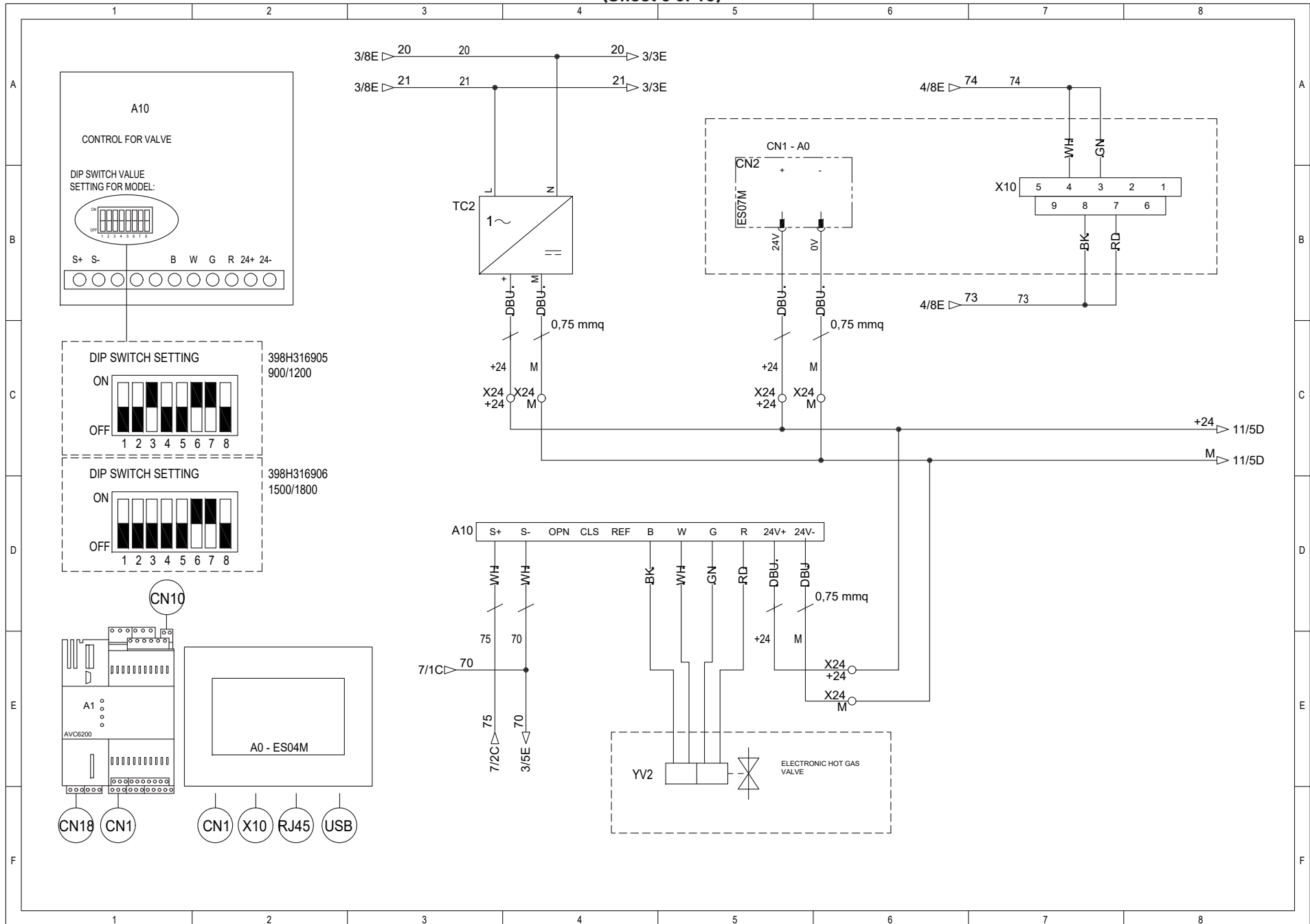

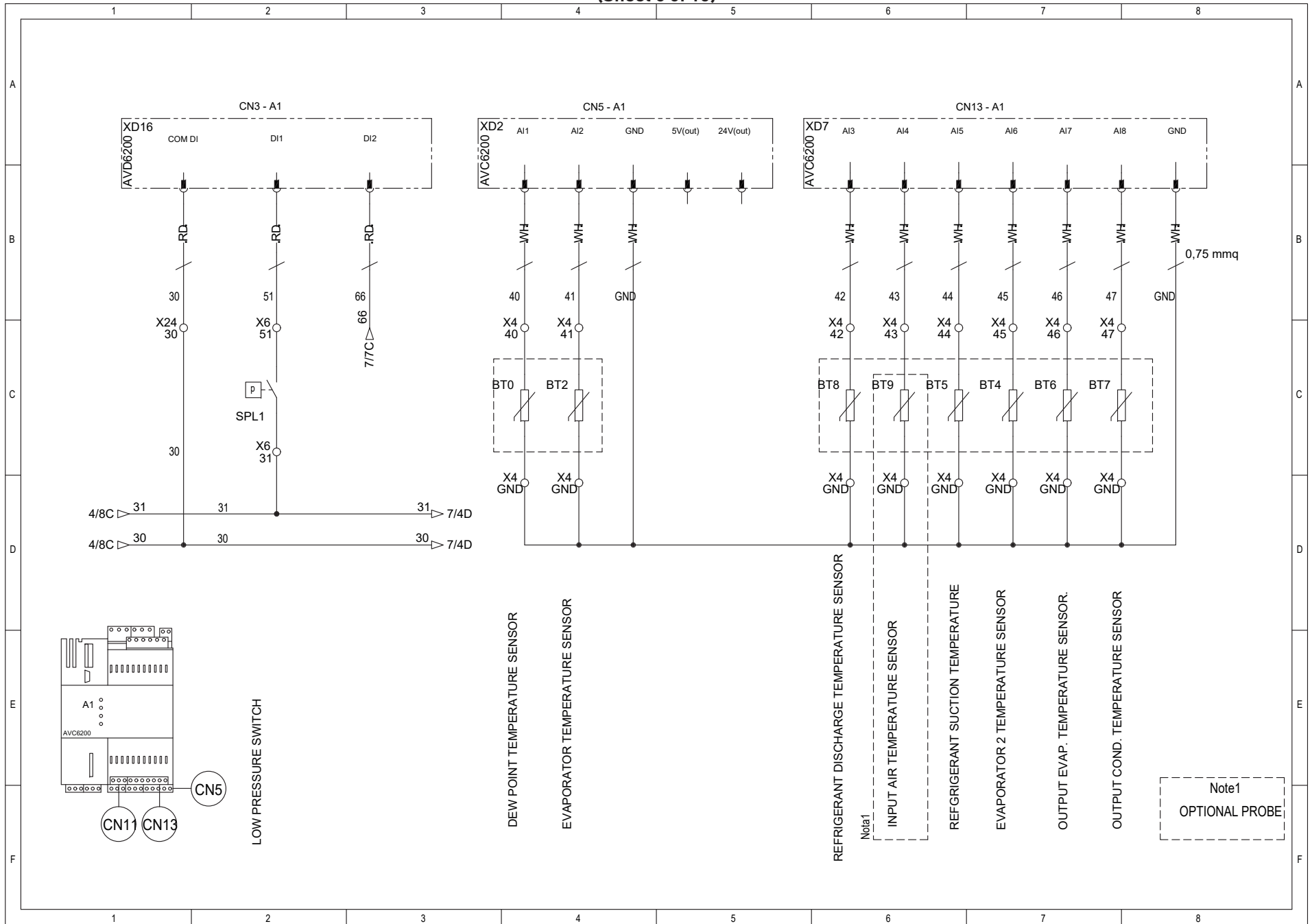

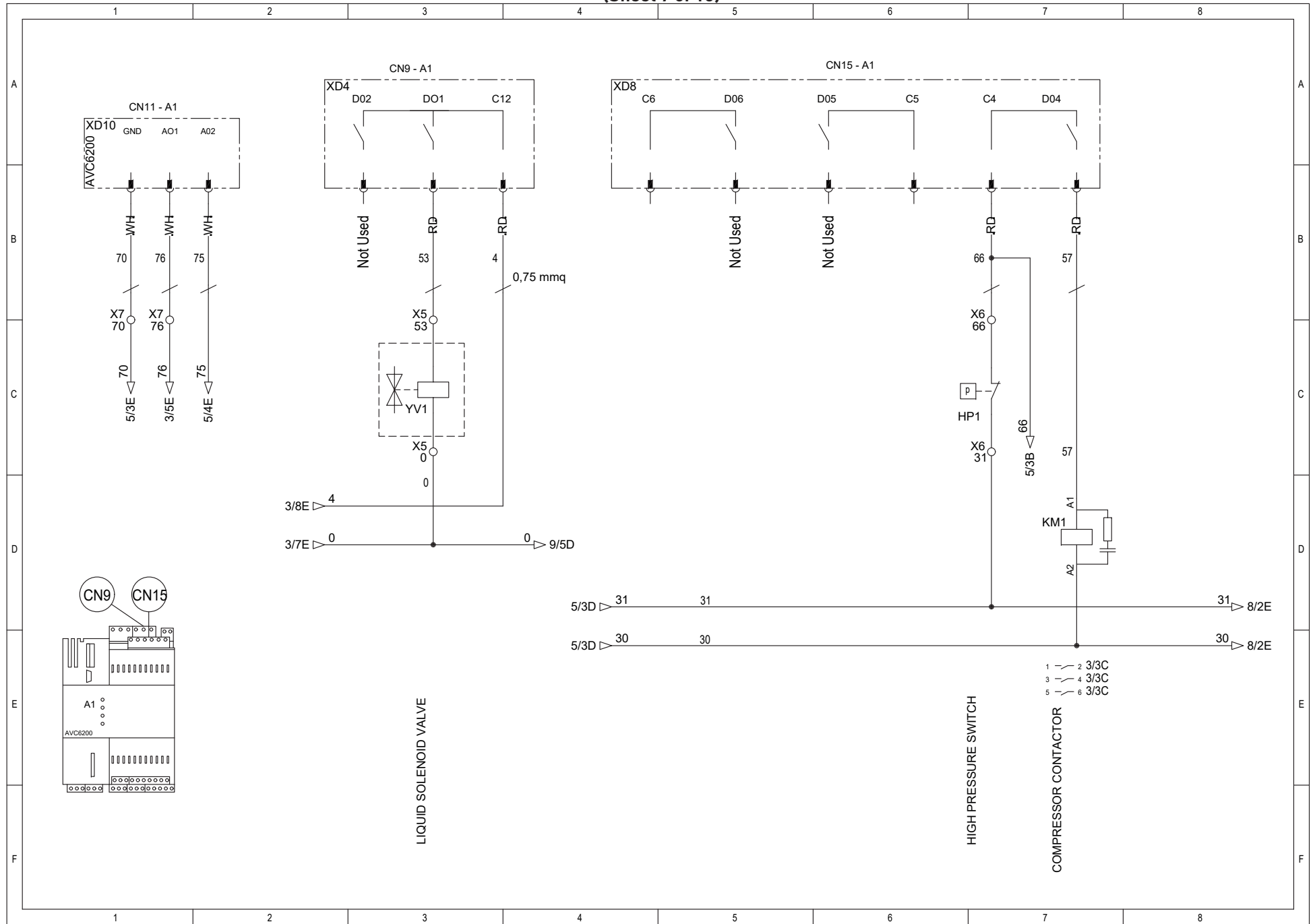

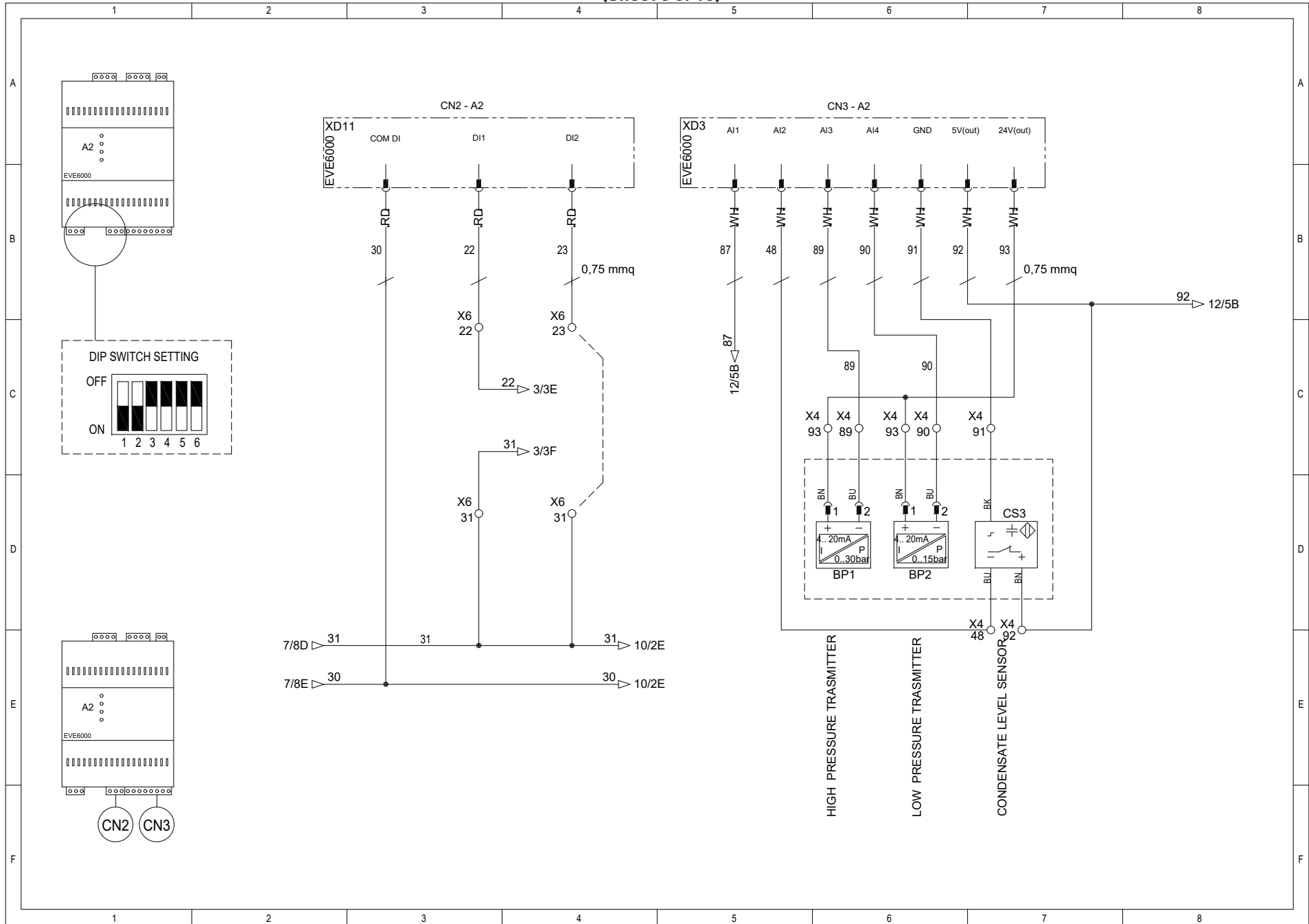

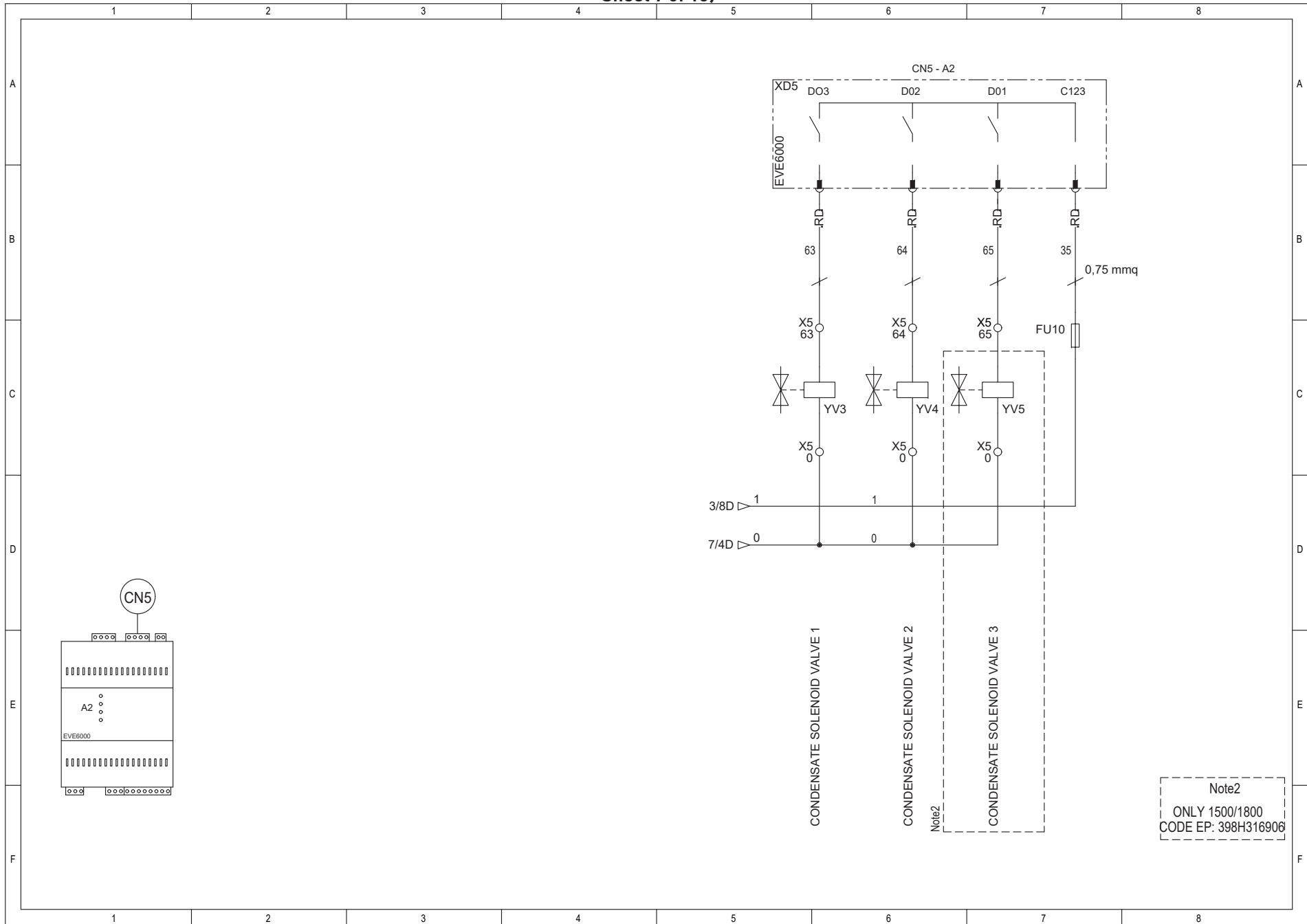

Note2
ONLY 1500/1800
CODE EP: 398H316906

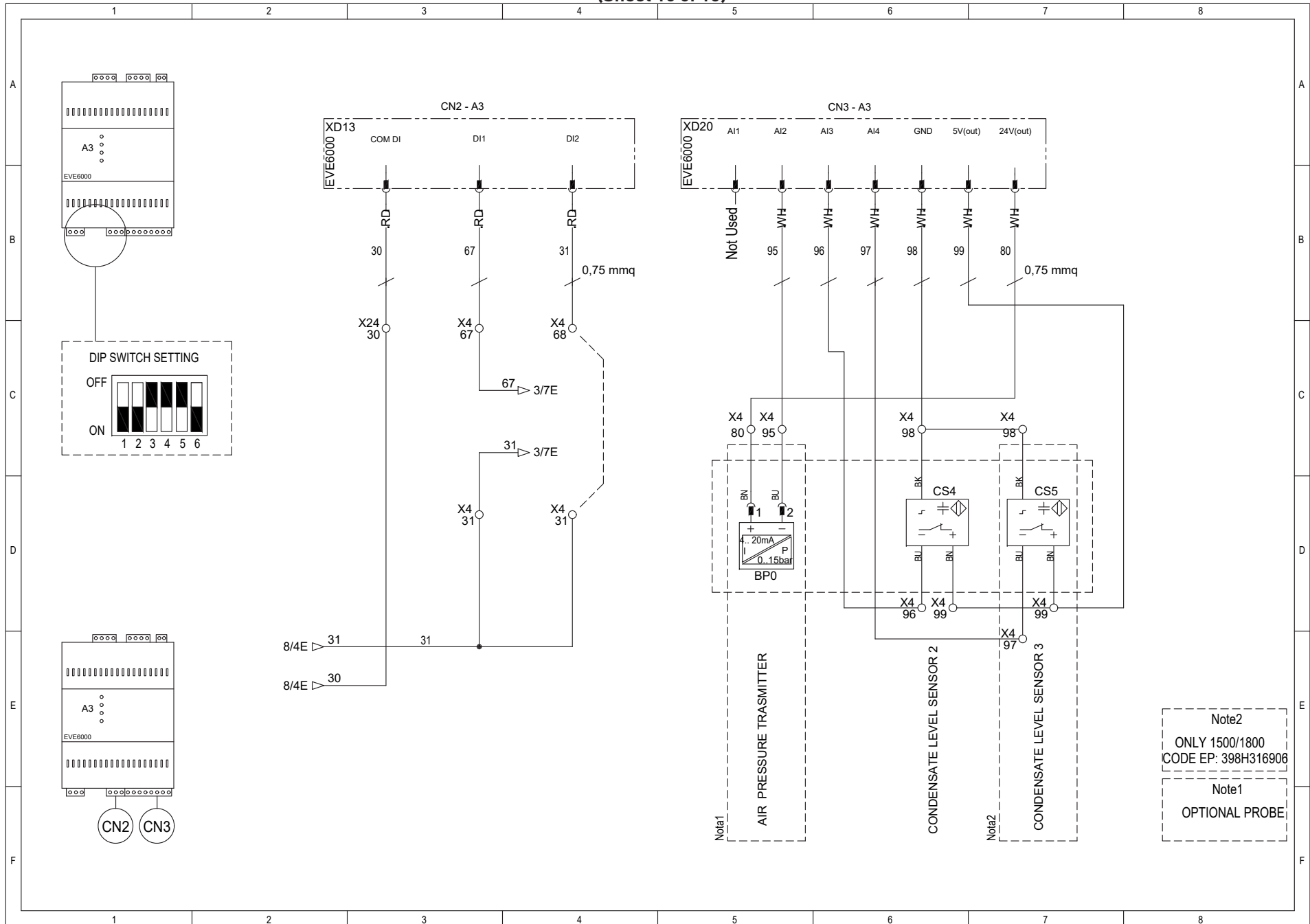

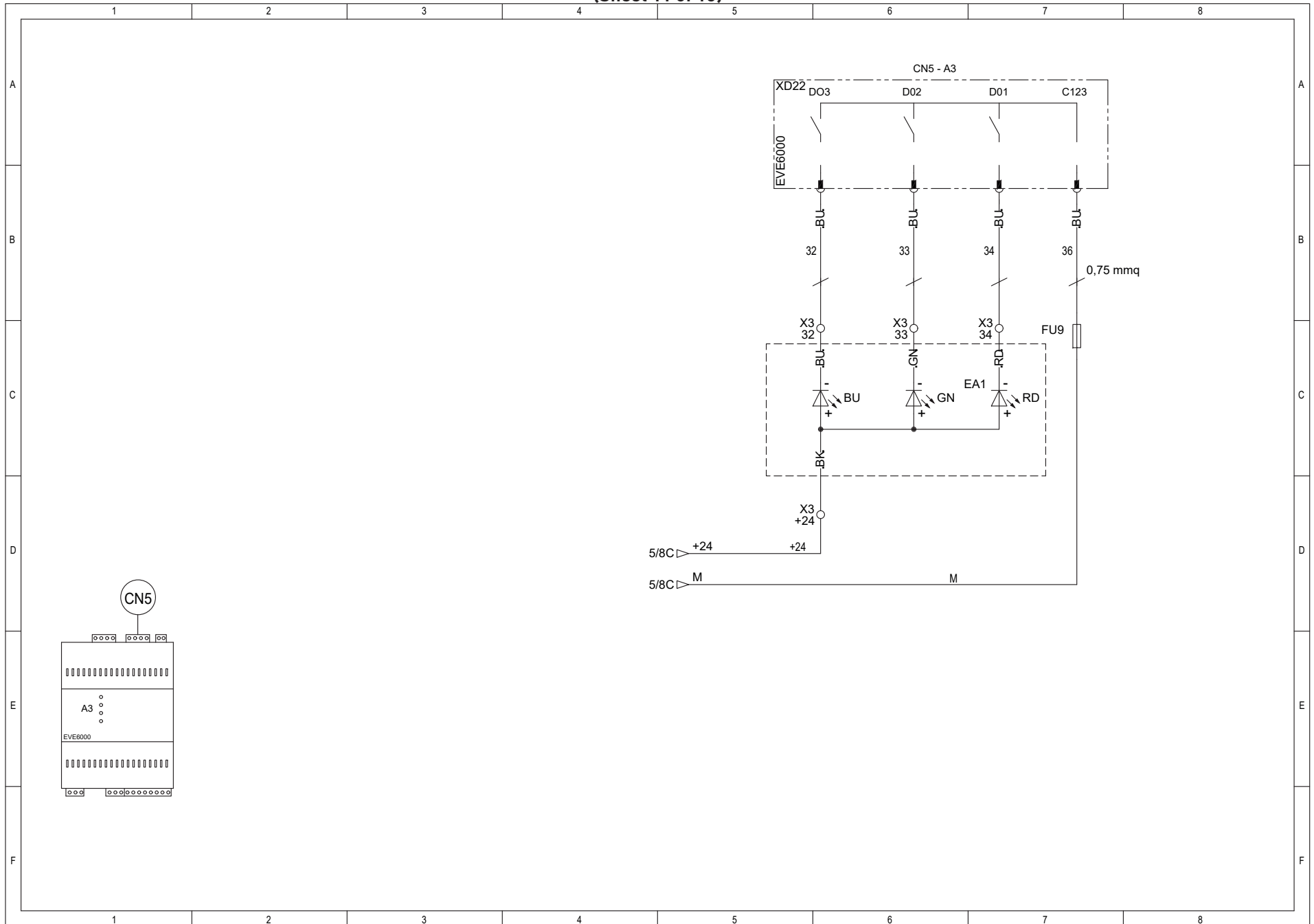

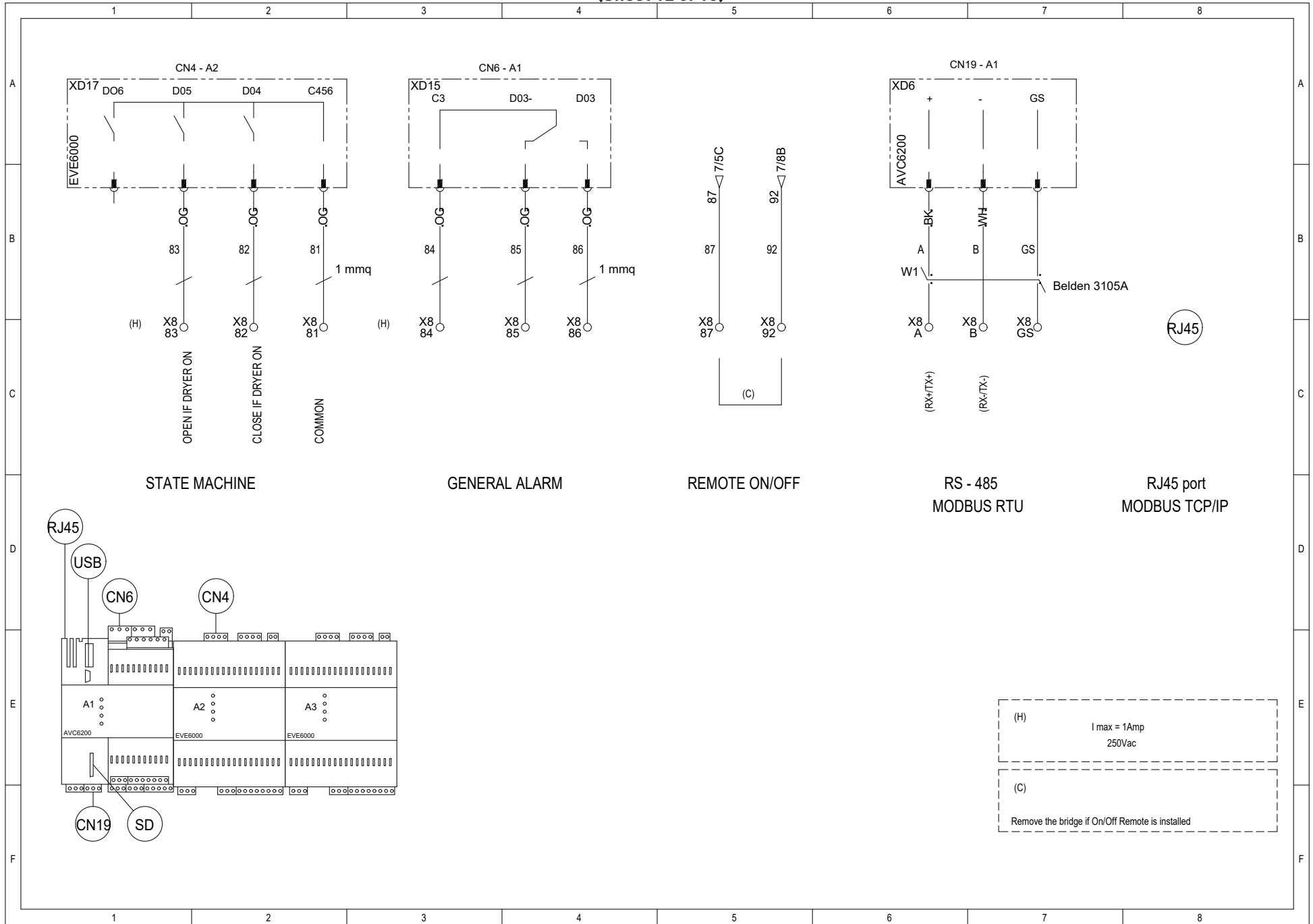

	1	2	3	4	5	6	7	8
A	PHOENIX CONTACT							
	PTT1.5	PTT1.5	PTT1.5	PTT1.5	PTT1.5	PTT1.5	PTT1.5	PTT1.5
B	Terminal Block	X3	X5	X4	X6	X24	X8	X0
	Terminal	32	53	40	66	24	87	S8
	level down	34	0	GND	31	24	87	S6
	link down							S7
	level up	32	53	40	66	24	87	S8
	link up	2						S6
	wire up	BU	63	WH	66	24		S7
	wire down	RD	0	BK	31	24		S7
		GN	63	BN	51	24		T
		BK	64	BN	68	24		S
C		0	WH	67				R
		0	WH	67				PE
		0	WH	67				
		0	WH	67				
		0	WH	67				
		0	WH	67				
		0	WH	67				
		0	WH	67				
		0	WH	67				
		0	WH	67				
D		0	WH	67				
		0	WH	67				
		0	WH	67				
		0	WH	67				
		0	WH	67				
		0	WH	67				
		0	WH	67				
		0	WH	67				
		0	WH	67				
		0	WH	67				
E		0	WH	67				
		0	WH	67				
		0	WH	67				
		0	WH	67				
		0	WH	67				
		0	WH	67				
		0	WH	67				
		0	WH	67				
		0	WH	67				
		0	WH	67				
F		0	WH	67				
		0	WH	67				
		0	WH	67				
		0	WH	67				
		0	WH	67				
		0	WH	67				
		0	WH	67				
		0	WH	67				
		0	WH	67				
		0	WH	67				

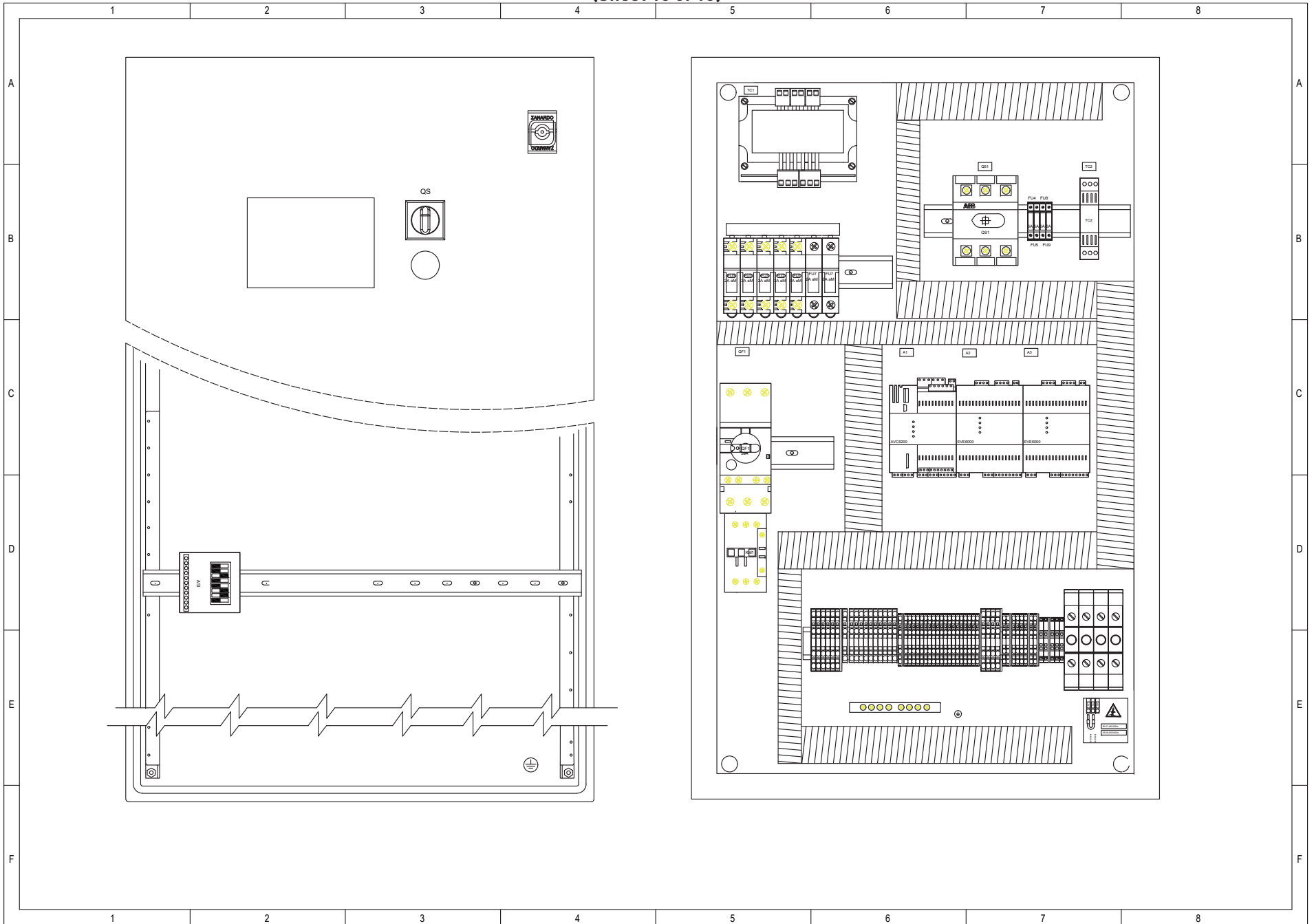



A division of Parker Hannifin Corporation

Parker Hannifin Manufacturing S.r.l.

Sede Legale: Via Sebastiano Caboto 1, Palazzina "A" 20094 Corsico (MI) Italy

Sede Operativa: **Gas Separation and Filtration Division EMEA** - Strada Zona Industriale,
35020 S. Angelo di Piove (PD) Italy

tel +39 049 971 2111- fax +39 049 9701911

Web-site: www.parker.com

ENGINEERING YOUR SUCCESS.